

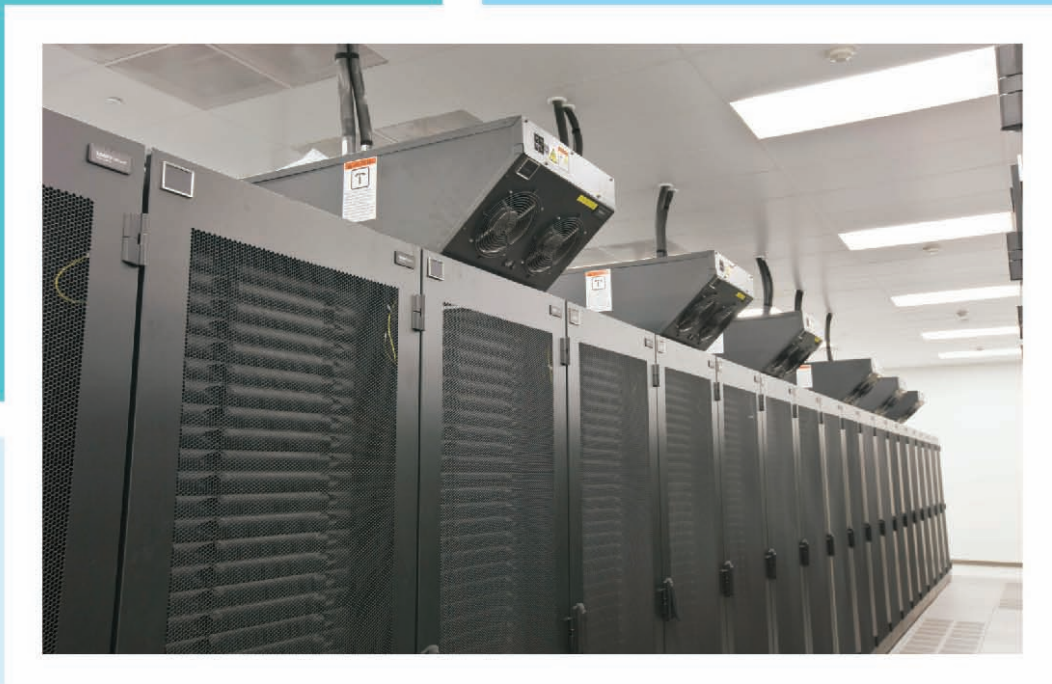

Confederation of Indian Industry
Since 1895



Bureau of Energy Efficiency



Energy Efficiency Guidelines & Best Practices in **Indian Datacenters**



Confederation of Indian Industry
Since 1895



Bureau of Energy Efficiency



Energy Efficiency Guidelines & Best Practices in **Indian Datacenters**

Disclaimer

© 2010, Bureau of Energy Efficiency (BEE), Ministry of Power, Government of India

All rights reserved. No part of this publication may be reproduced, stored in a retrieval system, or transmitted, in any form or by any means electronic, mechanical, photocopying, recording or otherwise, without the prior written permission from Bureau of Energy Efficiency (BEE), Ministry of Power-Government of India.

While every care has been taken in compiling this Manual, neither BEE nor Confederation of Indian Industry (CII) accepts any claim for compensation, if any entry is wrong, abbreviated, cancelled, omitted or inserted incorrectly either as to the wording, space or position in the Manual. The Manual is only an attempt to create awareness on energy conservation and sharing of best practices being adopted in India as well as abroad.

“Manual on Energy Efficiency guidelines and Best Practices in Indian Datacenters” was supported by a grant from Bureau of Energy Efficiency (BEE), Ministry of Power, Government of India to promote Energy Efficiency initiative in Indian Datacenters.

Published by Bureau of Energy Efficiency (BEE), Ministry of Power, Government of India.

FOREWORD

The service sector has been experiencing a significant growth in India and a major part of this is attributable to the IT Sector. High tech facilities in this sector is making it one of the fastest growing energy use sectors. The worldwide explosion of data in electronic form has resulted in establishment of mega data centres which are challenged by their high energy consumption is estimated that the initial cost of setting up of Data Center is only 5% of its total cost over its life cycle of 15-20 years with energy costs making up the largest fraction of costs.

The data centre sector has been focusing on energy savings, and a number of constraints which building-envelope energy efficiency have been taken up. Assessment support that further confronts in design and operation of the servers and the buildings could reduce power requirements by over 30%.

Considering this huge opportunity of improving energy efficiency in Data Centres, BEE together with CII has developed a manual on “Energy Efficiency guidelines and best practices in Indian Data Centres” together with the active involvement of all stakeholders in this sector.

I am confident that this manual will serve as a valuable reference document in promoting efficient design and energy efficient operations of Indian Data Centres.

I would like to thank all the Core Group members for their valuable contribution in the development of this manual through analysis of various energy efficiency issues in the management of Data Centres. I would also like to place on record my appreciation for the Steering Committee members for their guidance of this task.

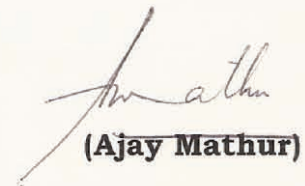
(Ajay Mathur)

Acknowledgement

A nation of a billion plus is on the rise with a sustained economic growth of more than 8% and energy is considered to be the lifeblood of its success. With the increasing national energy consumption blended with the Climate Change issues which actually intensify our focus on energy efficiency. The services sector has been experiencing a significant growth in India and a major part of this is attributable to the IT sector. The worldwide explosion of data in an electronic form has resulted in establishment of mega Data Centers.

Leapfrogging with a low-carbon-economy, Indian IT and other stakeholders has to enhance energy competitiveness and reduce carbon footprints.

Energy Efficiency Guidelines and Best practices in Indian Datacenter: A sourcebook for Indian Datacenter industry is developed under the initiative of Bureau of Energy Efficiency (BEE) and Confederation of Indian Industry (CII).

CII wish to thank all the stakeholders of Datacenter for their generous assistance in the execution of the project. The guidance of BEE and valuable assistance of members has facilitated CII in developing, compiling and reviewing of the document.

We are indebted to **Dr Ajay Mathur**, Director General, BEE and **Mr Sanjay Seth**, Energy Economist, BEE for providing extensive guidance and review throughout the preparation of the document.

The steering committee, Core Group Members and other experts worked closely to develop this comprehensive report.

On behalf of CII, it is our pleasure to thank all individual Core group Chairman, the members of the steering committee and Core-Groups and stakeholders for their contribution towards the finalization of this document.

CII highly appreciates the contribution of the following steering committee members for the preparation of this document.

Mr Aravind Sitaraman, Cisco Systems (India) Private Limited

Mr Ashish Rakheja, Spectral Services Consultants Pvt Ltd

Prof R Balasubramaniam, Indian Institute of Technology, New Delhi

Mr Deepak Bhardwaj, Texas Instruments (India) Private Limited

Mr R Muralidharan Iyengar, Blue Star Limited
Mr Pramod Deshmukh, Hewlett Packard India Sales Pvt Ltd
Mr Sandeep Nair, Emerson Network Power (India) Pvt Ltd
Mr Sanjesh Gupta, Wipro Infotech
Dr Sathish Kumar, USAID ECO-III Project, IRG
Mr Srinivas Chebby, American Power Conversion (APC)
Mr Sanjeev Gupta, IBM India Pvt Ltd
Ms Shaheen Meeran, Schnabel, DC Consultant India
Mr Sudhir Shetty, Intel Technology India Pvt Ltd
Mr Sujeet Deshpande, Tata Communications Ltd
Mr. Suresh Balakrishnan, STULZ-CHSPL India Pvt Ltd.
Mr Tanmoy Chakrabarty, Tata Consultancy Services
Mr Uday Bhaskarwar, Infosys Technologies Ltd

CII would like to thank and acknowledge Dr Dale Sartor, Applications team, Lawrence Berkeley National Laboratory for his valuable time and sharing the experience with all the members of the project.

CII thanks the following companies for their participation and support in the field visit and sharing their best practices.

- ❖ Cadence Design Systems (I) Private Limited
- ❖ Cisco Systems (India) Private Limited
- ❖ Ctrl S Datacenters Limited
- ❖ Hewlett Packard India Sales Private Limited
- ❖ Infosys Technologies Limited
- ❖ Intel Technology India Private Limited
- ❖ Sun Microsystems India Private Limited
- ❖ Wipro Technologies

In conclusion, CII thanks all the members, participating companies and experts who had contributed for this initiative.

About the Manual

This manual contains the following,

- › Information about the latest trends & technologies in Datacenters and its associated systems
- › The best practices adopted in various Datacenters for improving energy efficiency levels. Case studies elucidating the technical details and the financial benefits of adopting certain measures for higher energy efficiency
- › Guidelines for setting up Energy Efficient Datacenters
- › Key indicators to assess the performance of existing systems
- › Information to set section-wise targets for energy conservation goals

How to use this manual

- › Each chapter in this manual focuses on energy efficiency in particular areas such as Datacenter cooling, IT peripherals, electrical system, etc. Hence, the chapters can be read independently, and or in random order
- › Best Practices presented in this Manual have been proven to enhance the energy efficiency of the existing systems described in the Case Studies. However they should be suitably adapted and fine-tuned for implementation in other Datacenters, outside the settings described
- › The technologies mentioned and discussed in the Manual are the current ones at the time of publication. As newer technologies emerge, their suitability to existing and future projects needs to be studied

Contents

No.	Description	Page No.
	Foreword	
	Executive Summary	
	Introduction	
Chapter 1	Datacenter Overview	1
	1.0 Introduction	3
	1.1 Datacenter Growth trend	3
	1.2 Present scenario & future growth	3
	1.3 Source of Datacenter Power Consumption	4
	1.4 Classification of Datacenters	4
	1.5 TIA - 942 Standards	5
	1.6 Datacenter Tiers	6
	1.7 Datacenter Architecture	8
Chapter 2	Datacenter Electrical System	9
	2.0 Introduction	13
	2.1 Electrical Requirements of Datacenter	13
	2.2 Power flow in a Datacenter	14
	2.3 Diesel Generator Set	15
	2.4 Transformer	18
	2.5 Transfer Switch arrangement	20
	2.6 Transient Voltage Surge Suppressor (TVSS)	21
	2.7 Distribution Board	25
	2.8 Uninterrupted Power Supply (UPS) System	25
	2.9 Power Distribution Units	34
	2.10 Static Switch	36
	2.11 Advanced Power strip	36
	2.12 Energy saving Opportunities in Electrical Systems	37
	Case Study 1 Power Quality improvement in a Datacenter by installing Harmonic Filters	43
	Case Study 2 Energy Efficiency improvement in UPS Systems by Loading Optimization	46
	Case Study 3 Energy Efficiency improvement in Lighting System by replacing fluorescent lamps with Light Emitting Diode (LED) Lamps	50

Chapter 3	Datacenter Cooling	53
	3.1 Introduction	57
	3.2 Cooling process in a Datacenter	57
	3.3 Critical Cooling configuration and its components	59
	3.4 Precision Air Conditioner (PAC)	61
	3.5 Criteria for cooling system design	63
	3.6 Process of cooling in a Datacenter	65
	3.7 Determining heat output of a system	66
	3.8 Cable Management	66
	3.9 Energy Conservation measures in the Air-Conditioning System	66
	Case Study 4 Potential benefits of economizer in cooling system	81
	Case Study 5 Introduction of Intelligent Controller for multiple CRAC unit system	85
	Case Study 6 Benefits of Electronically Commuted (EC) fans for varying air requirement	88
	Case Study 7 Potential benefits of hot aisle / cold aisle containment	91
	Case Study 8 Introduction of systematic cable management for better air distribution in raised floor system	95
	Case Study 9 Benefits of humidity control for energy efficiency in Datacenter	97
	Case Study 10 Benefits of redefining Inlet conditions for energy efficiency in Datacenter	100
	Case Study 11 Benefits of water cooled cabinets in cooling system	105
	Case Study 12 Operate IT equipment cooling system at a higher temperature difference	107
	Case Study 13 CFD simulation for enhanced Datacenter productivity	109
	Case Study 14 Thermal storage system for emergency cooling requirements	111
Chapter 4	IT Equipment and Peripherals	113
	4.1 Introduction	117
	4.2 Server power consumption	118
	4.3 Challenges in critical cooling	119
	4.4 Strategies for reducing energy consumption	119
	4.5 Energy conservation measures in IT equipment	128

	Case study 15	Benefits of accelerated server refresh strategy	134
	Case study 16	Enterprise computing performance improvement through consolidation of datacenters	137
	Case study 17	Network virtualization for performance Improvement	139
	Case study 18	Effective storage utilization to optimize datacenter operational cost	141
	Case study 19	Infrastructure efficiency improvement in a virtualized environment	144
Chapter 5	Operation and Maintenance		151
	5.1	Significance of Operation and Maintenance	155
	5.2	Technical Documentation & Internal Training	155
	5.3	Manpower and Training	156
	5.4	Housekeeping	156
	5.5	Preventive Maintenance	157
	5.6	Breakdown Maintenance	157
	5.7	Condition Based Monitoring	158
	5.8	Capacity vs. Utilization	158
	5.9	Metering & Calibration	159
	5.10	Routine Audits	159
	5.11	Change Management	160
	5.12	Management Information System (MIS)	164
	Case study 20	Capturing the benefits through metering and monitoring system for effective energy management	171
Chapter 6	Role of Management in Datacenter Energy Efficiency		177
	6.0	Introduction	179
	6.1	Role of management	179
	6.2	Energy Management Strategies	180
	6.3	Components of energy management	181
	6.4	Conclusion	183
Annexure 1	Grounding		185
Annexure 2	Air Management & Air Distribution Metrics		186
Annexure 3	Twenty Seven things to meet "Twenty Four by forever" expectations		187
Annexure 4	Datacenter Benchmarking Guide		190
Annexure 5	List of Energy Saving Opportunities in Datacenter		197
	References		199
	Terms & Definitions		202

Executive Summary

In the past decade, India has witnessed an exponential increase in the demand for digital storage, from 1 petabyte in 2001 to more than 34 petabytes by 2007. They also continue to grow at a compounded rate of 25-30%.

Datacenter growth is driven by increasing requirements from the sectors such as financial institutions, telecom operators, manufacturing and services. While large financial institutions and telecom companies are likely to build captive Datacenters for hosting their growing data storage needs, Datacenter service providers are expected to invest significantly to multiply their capacities, so as to fulfill the demand arising from small and midsize users.

Datacenter is highly energy intensive. With the increasing energy cost, the increase in operational cost is inevitable. Therefore it becomes necessary to reduce the energy consumption to offset the increasing operational cost and to maintain competitiveness. Hence the Datacenters in India need to incorporate innovative designs for energy efficiency and embrace the concept of “Green IT” for sustained growth.

Existing Datacenters need to adopt the best practices in design, operation and maintenance to achieve operational excellence. New datacenters have to adopt the energy efficiency measures by design. The objective of this manual is to identify and disseminate the best practices followed in Indian Datacenters as well as provide guidelines on incorporating energy efficiency aspects at design stage for new datacenter.

The Bureau of Energy Efficiency (BEE), Ministry of Power, Govt of India assigned CII the task of identifying the best practices on Energy efficiency adopted in Datacenters and publishing it in the form of a manual.

Under the leadership of Dr Ajay Mathur, Director General, BEE a steering committee comprising of various stakeholders like Datacenter Users, Datacenter designers, IT equipment specialists, IT Service Providers, Datacenter cooling & Electrical equipment suppliers, and Datacenter Consultants was formed.

Four Core groups focusing on four major areas (Electrical accessories, Critical Cooling (HVAC), IT peripherals and Operation & maintenance) visited more than ten Datacenters across the country to identify and bring out the best practices adopted as well as develop guidelines for new datacenter.

The manual has detailed out three major components of a Datacenter, and also focused on Operation and Maintenance aspects of the same as individual chapters. The chapters brief on the basic function of respective area and focus on energy saving measures supported with case studies.

- › Electrical system/Power - Power management is emerging as a key tool to reduce the Total Cost of Ownership (TCO) and increase the return on investment on infrastructure costs. The chapter includes the energy saving opportunities through fine-tuning of UPS loading, transformer loading and installation of harmonic filters. Emerging technologies such as LED lighting, Modular UPS system and Rotary UPS system are also covered

- ▶ Critical cooling system - Over the years, the increase in processor densities have led to increased power & intensity of cooling. This is driving the datacenter market, towards innovative cooling techniques that can manage excessive heat generated due to increased processor densities. This manual highlights, in detail, various technologies and strategies that will help in achieving optimum cooling efficiency in a Datacenter. Emerging technologies such as cooling system economizer, thermal storage system, and water cooled systems are discussed in detail
- ▶ IT peripherals - With increasing levels of complexity involved in deploying IT solutions, Datacenter managers are increasingly looking for solutions that are more intelligent, in order to achieve energy efficiency and manage key resources. Virtualization in Datacenter offers various benefits like increased resource utilization, decreased power and cooling consumption, faster provisioning, and saving in space requirements. The chapter covers the energy saving opportunities through adoption of high density servers, virtualization of servers & network component, optimization of storage utilization, and infrastructure efficiency improvement in a virtualized environment
- ▶ Operation and Maintenance - With companies relying significantly on IT infrastructure, network downtime has a severe impact on its business. As a result, continuous operation of Datacenter has become extremely vital. The chapter discusses the best practices related to operation and maintenance which helps in reduction of downtime in a datacenter

More than twenty best practices have been identified and are detailed in the individual chapters of the manual.

The following best practices identified which offer high replication potential in the Indian Datacenters. These best practices have been discussed in detail in the manual.

1. Power quality improvement in Datacenter by installing harmonic filters
2. Energy efficiency improvement in UPS system by loading optimization
3. Deployment of Hot aisle/cold aisle containment for enhanced air management
4. Introduction of Intelligent controller for multiple Computer Room Air-conditioner (CRAC) unit system.
5. Operation of IT equipment cooling system at a higher temperature difference
6. Installation of Thermal storage system for emergency cooling requirement
7. Deployment of accelerated server refresh strategy for IT performance improvement
8. Infrastructure efficiency improvement in a virtualized environment
9. Effective utilization of storage system to minimize Datacenter operation cost
10. Installation of metering and monitoring for effective energy management

The following are the few emerging technologies which offer high replication potential and can be incorporated by design in newer datacenters.

1. Expansion of Datacenter capacity with water cooled cabinets

2. Installation of cooling system economizer
3. Improvement of Energy efficiency in lighting system by replacing fluorescent lamps with Light Emitting Diode (LED) Lamps
4. Installation of Rotary Uninterruptible power supply (Rotary UPS)

Typically, for a conventional datacenters with operating Power Usage Effectiveness (PUE) of 2.0, the minimum energy saving potential by adoption of latest technologies is between 25 to 30%.

The table* below indicates the impact of various energy saving technologies on the overall energy saving potential in a Datacenter.

Energy saving technology	Percentage impact in overall saving potential
Server virtualization	40%
More power efficient servers	20%
More efficient facilities infrastructure (e.g. CRACs, PDUs, etc)	7%
More power efficient storage system	6%
More power efficient network equipment	5%
Data storage management technologies	5%
Server or PC power management software	4%
Use of alternative or renewable energy	4%
Tiered storage	4%
Other	5%

This manual is a guideline and compilation of best practices & efficient technologies for incorporating energy management in Datacenters. The adoption of these best practices and technologies would enable achievement of better energy efficiency.

The manual also forms a critical part of the overall efforts of Bureau of Energy Efficiency and CII, towards reducing energy intensity of the Indian economy through adoption of energy efficiency practices involving all stakeholders.

* Source: *dotnet developer's journal*

Introduction

India being the hub of IT activities, the increasing IT business process outsource from foreign countries has resulted in phenomenal growth of Datacenters in India. The total datacenter capacity in India is growing at a rapid pace and is expected to exceed 5.1 million square feet by 2012*, which translates to a compounded Annual Growth Rate of 25-30% in IT businesses.

Datacenters are highly energy intensive which implies high cost on the organization for its operation. Increasing energy cost imposes tremendous pressure on the developers for energy efficient Datacenters by design. It also compels the users to design and operate their Datacenters in an energy efficient manner.

Energy efficiency in Datacenters offers three fold benefits:

1. Increased national availability of energy
2. Reduction in operating costs
3. Enhanced efficiency in datacenter design & operation leading to climate change mitigation

With this background, Bureau of Energy Efficiency (BEE) - an independent body working under ministry of power, government of India has taken an initiative to bring out best operating practices that would result in energy efficiency and design guidelines for Datacenters.

BEE had earlier formulated Energy Conservation Building Code (ECBC) to promote energy efficiency in commercial building sector. The code has been well received across the country. Subsequent to ECBC, BEE has now brought out a Manual on best operating practices and Design guidelines for Energy Efficiency in Indian Datacenters.

The manual has been developed by Confederation of Indian Industry under the guidance of BEE and the steering committee. The steering committee has been formed under the chairmanship of Dr Ajay Mathur, Director General, BEE to assist CII in executing the project.

Steering committee

A steering committee was constituted comprising of various stake holders such as Datacenter designers, IT specialists, Service providers, HVAC & Electrical equipment suppliers, Consultants, Users & Experts. Individual core groups were formed to focus on the four major areas of the Datacenter. The core groups have regularly consulted Mr. Sanjay Seth, Energy Economist, BEE for execution of the project.

Core group

1. Electrical system
2. Critical cooling
3. IT Peripherals and systems
4. Operations & Maintenance

Chairman

- Mr Dhiman Ghosh
Emerson Network Power
- Mr Ashish Rakheja
Spectral Services consultants Pvt. Ltd.
- Mr Chandrashekhar Appanna
Cisco Systems, Inc.
- Mr Sudeep Palanna
Texas Instruments

*Source : Gartner Inc.

CII technical team with the support of core group members have visited more than 10 Datacenters to study and collate the best practices adopted. All the four core group members have contributed extensively by sharing the knowledge and information for the successful completion of the manual. The core group members together have identified 20 best practices for energy efficiency improvement in Datacenters. CII thanks all the members of steering committee and core groups for their excellent support and valuable inputs.

Best Practices Manual

All the best practices identified by the core groups have been reviewed by the steering committee members. All the inputs and suggestions of the steering committee members have been included in the manual.

The main objectives of the manual is to:

- ▶ Identify and collate the best operating practices in Indian and International Datacenters which can be replicated in various Datacenters to achieve energy efficiency
- ▶ Identify the state of the art technologies adopted in various energy efficient Datacenters which can be replicated in other Datacenters to achieve excellence in energy savings
- ▶ Disseminate information on the guide lines for setting up energy efficient Datacentres

Best Practices Manual brings out some of the best practices followed in Indian and International Datacenters. Case studies on best practices presented in this manual are in the areas of Electrical power distribution systems, Datacenter cooling, IT peripherals and systems and Operation & maintenance.

We wish that the datacenters in India will make use of this opportunity and improve their energy efficiency to move towards greener Datacenters and healthier environment.

Chapter 1

Datacenter Overview

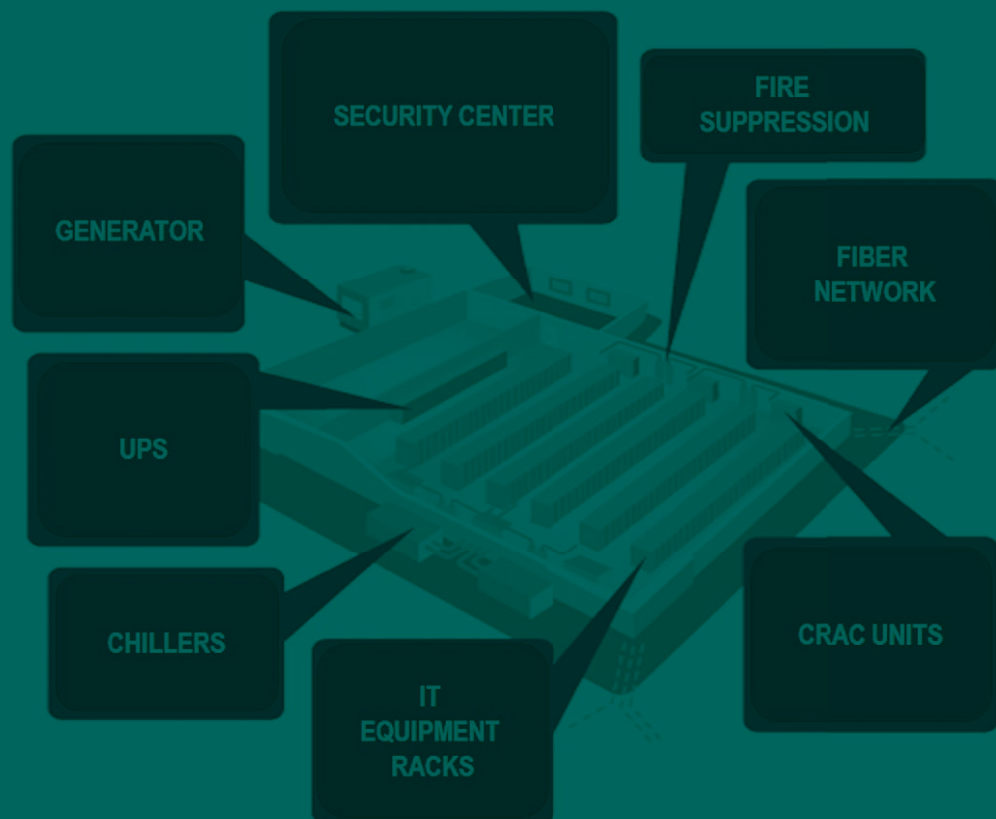

1.0.0 Introduction

As the trend shifts from paper-based to digital information management, Datacenters have become common and essential to the functioning of business systems. A Datacenter is a facility that has concentrated depository of various equipment such as servers, data storage devices, network devices etc. Collectively, this equipment processes, stores, and transmits digital information and is known as Information Technology (IT) equipment.

Fundamentally, the Datacenter is a physical place that houses a computer network's most critical systems, including backup power supplies, air conditioning, and security applications.

1.1.0 Datacenter growth trend

The Datacenter industry is in the midst of a major growth. The increasing reliance on digital data is driving a rapid increase in the number and size of Datacenters. This growth is the result of several factors, including growth in the use of internet media and communications and growth in the need for storage of enormous digital data. For example, Internet usage is increasing at approximately 10 percent per year worldwide (Source : comScore Networks 2007) and has directly fuelled the growth of Datacenters.

From simple data storage to a complicated global networking, Datacenters play a significant role and have become an integral part of the IT spectrum. However, the energy consumption of Datacenters have also grown with these activities. From 2000 to 2006, the energy used by Datacenters and the power and cooling infrastructure that supports them has doubled. In the United States of America (USA), the electricity usage of Datacenters is estimated at about 61 billion kilowatt-hours (kWh) which forms about 1.5% of the total energy consumption of USA (Source : USDOE, 2007).

With such high energy consumption, the energy efficiency of Datacenters has become the focal point of attention.

1.2.0 Present scenario and future growth of Datacenters in India

India being the nerve center for all IT activities and the outsourcing activities that demands high storage resulting in phenomenal growth of Datacenters in India. With the increase in business volume, the Indian data centre services market is poised to witness rapid growth in the coming years. The total Datacenter capacity in India is expected to grow from 2.3 million square feet in the year 2008 to 5.1 million square feet by the year 2012 and is projected to grow 31 % from 2007 to 2012 (Source: Gartner, INC). The storage demand which has increased from one petabyte in 2001 to 34 petabytes in 2007 (Source: Gartner, INC) has resulted in existing Datacenter capabilities being fully utilized and, consequently, the need has arisen to build more capacity.

However, the growth of Datacenters in India confronts certain major barriers and the greatest one being the lack of adequate energy for its operation and future expansion.

1.3.0 Sources of Datacenter power consumption

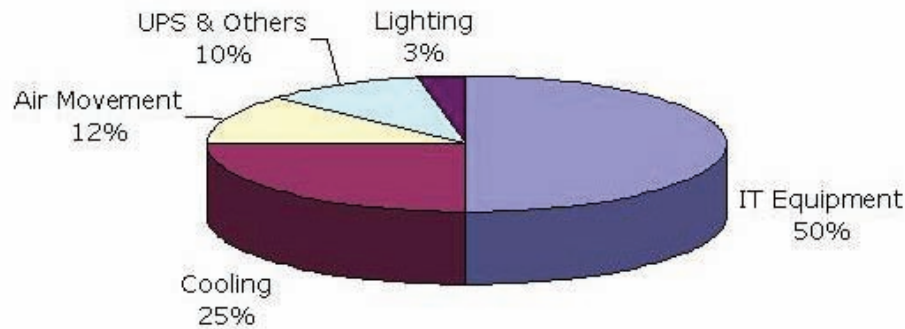

Figure 1: Power Usage Distribution in a Datacenter
[Source: EYP Mission Critical Facilities Inc. New York]

Power usage distribution in a typical Datacenter is shown in figure 1. From the figure 1, we understand that the IT equipment and its cooling system consume a major chunk of power in a Datacenter. Also, the cooling requirement in a Datacenter is based on the energy intensity of IT load in the Datacenter. Therefore, energy savings in IT load would have a direct impact on the loading of most of the support systems such as, cooling system, UPS system, power distribution units and thereby has effect on overall energy performance of the Datacenter

Typically the cooling system consumes 35 – 40 % of the total Datacenter electricity use. Demands on cooling systems have increased substantially with the introduction of high density servers. As a result, the cooling system represents the second highest energy consumer next to IT load.

1.4.0 Classification of Datacenters

Datacenters can be classified into two types namely Internet Datacenter (IDC) and Enterprise Datacenter (EDC).

1.4.1 Internet Datacenter

Internet Datacenters, also referred as co-location & managed Datacenter, are built and operated by service providers. However, IDCs are also built and maintained by enterprises whose business model is based on internet commerce. The service provider makes a service agreement with their customers to provide functional support to the customer's IT equipment. The service provider's IDC architecture is similar to that of enterprise IDC architecture. However the scalability requirement of enterprise IDC is lower because of a smaller user base and the services provided are less.

1.4.2 Enterprise Datacenter

Enterprise Datacenters support many different functions that enable various business models. Enterprise Datacenters are evolving, and this evolution is partly a result of new trends in application environments, such as the n-tier, web services, and grid computing, it is mainly because of the criticality of the data held in Datacenters.

The operation and maintenance of Datacenters is critical therefore, Telecommunications Industry Association (TIA) has formulated operating standards to address the requirements of Datacenter infrastructure.

1.5.0 TIA - 942 standards

TIA-942 is a standard developed by the Telecommunications Industry Association (TIA) to define guidelines for planning and building Datacenters, particularly with regard to cabling systems and network design. Intended for use by data centre designers early in the building development process, TIA-942 covers the following:

- › Site space and layout
- › Cabling infrastructure
- › Reliability
- › Environmental considerations

Site selection	
Proximity to flood hazard area	Not within 100-year flood hazard area or less than 91 m / 100 yards from 50-year flood hazard area
Proximity to coastal or inland waterways	Not less than 91 m/ 100 yards
Proximity to major traffic arteries	Not less than 91 m / 100 yards
Proximity to airports	Not less than 1.6 km / 1 mile or greater than 30 miles
Proximity to major metropolitan area	Not greater than 48 km / 30 miles
Building construction	
Type of construction	Type II-1hr, III-1hr or IV-1hr
Exterior/ Exterior bearing walls	1 Hour minimum
Exterior non bearing walls	1 Hour minimum
Structural frame	1 Hour minimum
Shaft enclosures	1 Hour minimum
Floors and floor-ceilings	1 Hour minimum
Roofs and roof-ceilings	1 Hour minimum
Meet requirements of NFPA 75	Yes

Building components	
Vapor barriers for walls and ceiling of computer room	Yes
Multiple building entrances with security checkpoints	Yes
Floor panel construction	All steel
Understructure	bolted stringer
Ceiling Construction	If provided, suspended with clean room tile
Ceiling Height	3 m (10 ft) minimum (not less than 460 mm (18 in) above tallest piece of equipment

1.5.1 Other major factors in site selection

- › Power availability and low power tariff
- › Preferred Seismic Zone below zone 3
- › Sufficient Water availability (for large Datacenter as water cooled systems have better energy efficiency)
- › Free from security threats

1.5.2 Advantages

The principal advantages of designing Datacenters in accordance with TIA-942 include:

- › Standard nomenclature
- › Fail -safe operation
- › Robust protection against natural or human made disasters
- › Long-term reliability, flexibility and scalability

The Datacenter redundancy is one of the most important factors in the designing stage of the Datacenter. Redundancy is a system design that duplicates components to provide alternatives in case one component fails. To maintain high availability levels, the Datacenter systems are always designed with redundancy. Based on the redundancy levels maintained in the Datacenters, the Datacenters can be categorised into four Tier levels.

1.6.0 Datacenter tiers (Source: Uptime Institute)

Datacenter tier standards define the availability factor of a Datacenter facility. The tier system provides a simple and effective means for identifying different Datacenter site infrastructure design topologies. The standards are comprised of a four-tiered scale, with Tier 4 being the most robust.

A Tier I Datacenter has no redundant capacity components and single non-redundant power distribution paths serving IT equipment. A typical example would be a computer room with a single UPS, generator and Heating Ventilation and Air Conditioning cooling system.

A Tier II Datacenter has redundant capacity components and single non-redundant power distribution paths serving the IT equipment. A typical example would be a computer room with a single UPS and generator, but a redundant cooling system.

A Tier III Datacenter has redundant capacity components and multiple distribution paths serving the IT equipment. Generally, only one distribution path serves the computer equipment at any time. All IT equipment is dual-powered and fully compatible within the topology of a site's power distribution architecture. A typical example would be a computer room with a single UPS that has maintenance bypass switch wrapped around the system and a generator. Also, it would have redundant cooling systems.

A Tier IV Datacenter has redundant capacity systems and multiple distribution paths simultaneously serving the IT equipment. The facility is fully fault-tolerant, through electrical, storage and distribution networks. All cooling equipment is independently dual-powered, including chillers and HVAC systems. An example of this configuration would be multiple UPSs serving the IT equipment through multiple paths with no single point of failure. The UPSs would be backed up by generators that are redundant and have no single point of failure .

Datacenters can also be classified based on the maximum IT load (kW) in the Datacenter. The classification is shown below:

Table 1: Classification of Datacenters Based on the Maximum IT Load

	SMALL	MEDIUM	LARGE	X LARGE
Site description	Mixed use building	Mixed use building	Mixed use or dedicated building	Mixed use or dedicated building
Average Size (Sq. ft)	125 - 1000	1000 - 5000	5000 – 25000	> 25000
Average number of IT racks	5 – 40	41 – 200	200 – 800	>800
Typical number of Servers	30 – 250	250 - 1300	1300 – 4000	>4000
Maximum design of IT load (kW)	20 - 160	160 - 800	800 - 2500	>2500

Source : APC

1.7.0 Datacenter architecture

Datacenter power delivery system provides backup power, regulates voltage, and makes necessary alternating current/direct current (AC/DC) conversions. The power from the transformer is first supplied to an Uninterruptible Power Supply (UPS) unit. The UPS acts as a battery backup to prevent the IT equipment from experiencing power disruptions. A momentary disruption in power could cause huge loss to the company. In the UPS the power is converted from AC to DC to charge the batteries. Power from the batteries is then reconverted from DC to AC before leaving the UPS. Power leaving the UPS enters a Power Distribution Unit (PDU), which sends power directly to the IT equipment in the racks.

The continuous operation of IT equipment generates a substantial amount of heat that needs to be removed from the Datacenter for the equipment to operate properly. Precision Air Conditioners (PAC) are used to remove the heat generated within Datacenters to the outside atmosphere. Two most important parameters which the PACs should maintain in the Datacenter space is temperature and humidity. The conditioned air from the PAC is supplied to the IT equipment through a raised floor plenum.

Datacenters use significant amount of energy to supply three key components: IT equipment, cooling, and electrical system. The three key components are covered individually in the coming chapters.

The main objectives of this manual are to:

- › Identify best operating parameters for Indian Datacenters
- › Identify and collate the best practices in Indian and International Datacenters which can be replicated in various Datacenters to achieve energy efficiency
- › Identify the state of the art technologies adopted in various energy efficient Datacenters which in turn can be adopted in other Datacenters to achieve excellence in energy savings

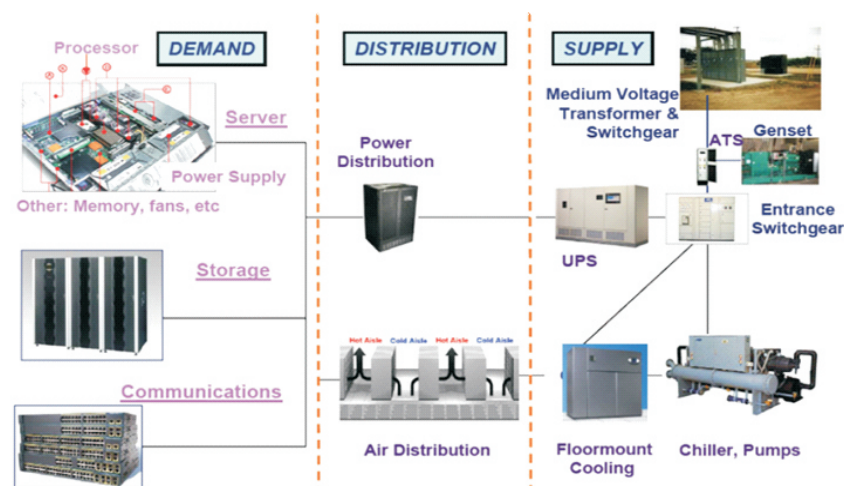

Figure 2: Typical Datacenter power consumption architecture

Chapter 2

Datacenter Electrical System



SUMMARY NOTE ON 'DATA CENTRE ELECTRICAL SYSTEM'

Increase in data center density and diversity are driving change in the power and cooling systems that business-critical servers and communications devices depend on for their performance and reliability. Rising equipment densities often correlate with increased criticality as companies deploy new applications that increase business dependence on data center systems. At the same time, entire facilities, as well as individual racks, are supporting an escalating number of devices as server form factors continue to shrink. This is creating the need for more and more electrical energy in a world which desperately needs to cut-down on Energy consumption. However, when critical infrastructure systems can respond to changes in density, capacity and availability created by new technology and changing business conditions, a greater operating flexibility, higher system availability, improved optimal fail-safe electrical design can be achieved and all this, in an Energy Efficient manner. It is essential to start planning and doing our Datacenter Electrical installations with high Efficiency benchmarks by choosing equipment having higher efficiency by design, selecting just the right, types, sizes and ratings of panels, devices and components, planning the layouts in a manner that minimizes transmission and heat losses. It requires a thorough understanding of power requirement of cooling system, the UPS systems and Utilities, the lighting loads and the critical IT loads. The power requirements of these elements may vary substantially but can be estimated precisely once the power requirement of the planned IT system is determined.

This initiative of CII under the able guidance of BEE involving the stake holders of the domain is truly a unique endeavour building higher degree of awareness about energy efficiency among the stakeholders through guidelines, recommendations and important best practices.

This chapter on 'Data Centre Electrical System' is an outcome of exceptional team work and has come out with significant focused stress points like Selection of Energy Efficient Transformers, Optimal Sizing and selection of all individual components, Intelligent loading on UPS Systems, implementation of effective Harmonic Filtration, power quality maintaining and monitoring, adoption of LED lighting system, etc.

I am extremely thankful to all members of this Group for their immense contribution towards the successful completion of this Chapter.

I would also like to express my sincere thanks to Mr. Suprotim Ganguly and Mr. D. Manikandan of CII for their significant insights from time-to-time, effective co-ordination and focused involvement and drive through out this project .



Dhiman Ghosh

Chairman, Core Group on 'Electrical System' &
Country Manager, Emerson Network Power (India) Private Ltd

LIST OF MEMBERS ON ELECTRICAL SYSTEM (CORE GROUP-1)

SI.NO	Name	Organization
1	Mr Anil Dev	Clivet TF Air Systems Pvt Ltd
2	Mr Anand Vanchi	Intel Technology India pvt Ltd
3	Prof. Balasubramaniam	Indian Institute of Technology, Delhi
4	Mr Brahma Reddy	Ctrl S Datacenters Ltd.
5	Mr. Dhiman Ghosh	Emerson Network Power (India) pvt Ltd
6	Mr Debashish Chakraborty	APC-MGE
7	Mr Guruprakash Sastry	Infosys Technologies Ltd.
8	Mr. K Hareesha	Texas Instruments (India) Pvt. Ltd
9	Mr Manu Kumar V	Hewlett Packard India Sales Pvt Ltd.
10	Mr Madhav Kamath	USAID ECO-III Project, IRG
11	Mr Nagarajan R	Cisco Systems India Pvt Ltd
12	Mr Nishant Kumar	IBM India Pvt. Ltd.
13	Dr. Prabhu Thangavelu	Emerson Design Engineering Center
14	Mr Puneet Gupta	Spectral Services Consultants Pvt Ltd
15	Mr Ranen Chattopadhyay	Wipro
16	Mr. Rajesh Swamy	APC MGE
17	Mr Radhakrishna H.S	Infosys Technologies Ltd.
18	Mr Sandeep Kumar	IBM India Pvt Ltd.
19	Mr Sailesh C. Zarkar	Iconic Designs
20	Mr Saurabh Goel	Spectral Services Consultants Pvt Ltd
21	Mr Sujith Kannan	Intel Technology India Pvt. Ltd.
22	Mr T.S. Saji	Wipro Infotech
23	Mr Varaprasad Nataraj	SCHNABEL dc Consultants India

2.0 Introduction

Every datacenter is unique in its operation and need. The infrastructure of a datacenter is customized depending on the mission it performs. It requires reliable operation of all the systems by the virtue of its business criticality. Today, technology is available to provide solutions which would bring down the power disruptions increasing the business proportion.

It is necessary to have the Infrastructure such as Products, Systems and Services that adequately meet the need as per the desired tier of availability. In addition, it is essential to understand the technology implemented in a datacenter to enhance information security and critical system protection.

Enhancing the efficiency by choosing high-efficiency equipment by design is often overlooked due to its high initial cost. However, considering total ownership cost makes the payback period to be attractive and viable.

Rising equipment densities often relates to increased criticality as companies deploy new applications that increase business dependence on Datacenter systems.

With the dynamic response to changes in density, capacity and availability created by new technologies and changing business conditions, a greater operating flexibility, higher system availability and lower operating costs can be achieved.

It is essential to determine the sizing of the electrical equipment for a Datacenter. It requires a thorough understanding of power requirement of cooling system, the UPS system, and the critical IT loads. The power requirements of these elements may vary substantially but can be estimated precisely once the power requirement of the planned IT system is determined. In addition, these elements can be used to estimate the power output capacity of a standby generator system.

2.1 Electrical requirements of Datacenter

The power requirement for IT equipment racks have changed in last 10 years due to development in technology.

In the recent years, the number of power receptacles required to support a fully populated rack grew from 14 to 84, as a result the total rack power consumption increased from 4 kW to more than 20 kW. The emergence of blade servers is driving change. Today, a standard rack can house six dual-corded blade chassis operating at 208 Volts, single phase, with a power consumption of 24 kW. This evolution has left Datacenter managers dealing with rising power consumption, increased demand for circuits, and greater diversity across the facility. These challenges have created the need for a power infrastructure capable of adjusting to changes in the number of devices, the density of those devices and where those devices are located.

2.2 Power flow in a Datacenter

The major components of power flow scheme from the substation to the IT equipment are shown in Figure 2.1.

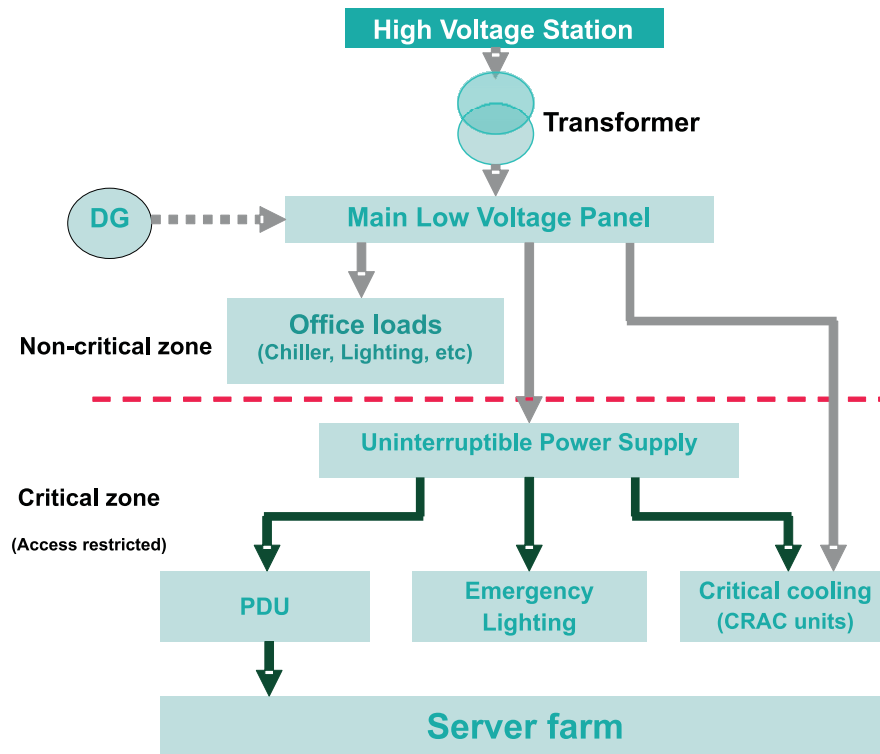

Figure 2.1: Power flow in a Datacenter

Major components of electrical infrastructure

- | | |
|---------------------------------------|--------------------------------|
| 1. Diesel Generator | 8. Transformer |
| 2. Distribution Panel | 9. Automatic Transfer Switches |
| 3. Transient Voltage Surge Suppressor | 10. Uninterrupted Power Supply |
| 4. Battery | 11. Power Distribution Board |
| 5. Static Transfer Switches | 12. Power Strip |
| 6. Monitoring | 13. Grounding |
| 7. Distributed Wiring | |

The following section describes the function & criticality of each component in designing Datacenter.

2.3.0 Diesel Generator set

Diesel generation system is a critical area which influences the operational reliability of a Datacenter. Diesel generation is used as backup power during the grid failure or other power system contingency.

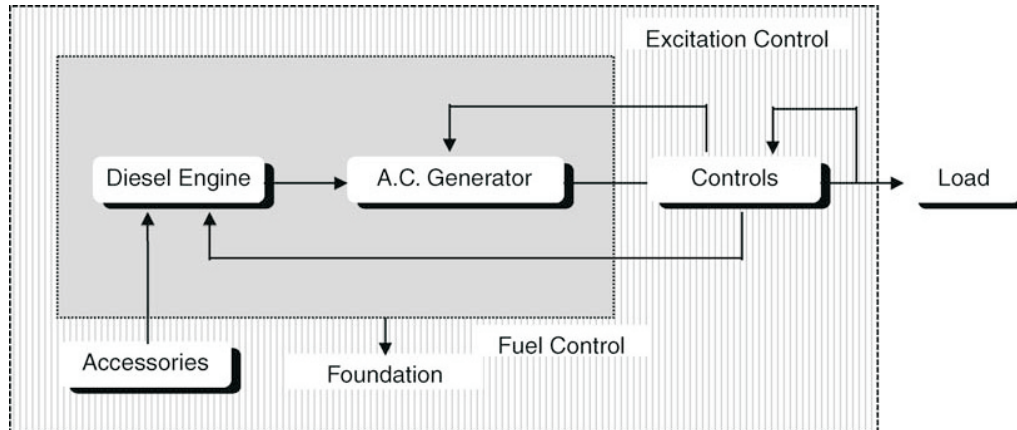

Figure 2.2: Basic Design of DG Set

2.3.1 Selection of DG set for Datacenter application

The selection of DG set should be based on life cycle cost. The following are the important factors to be considered during the selection of Diesel Generation set for a Datacenter.

a) Sizing of DG

The sizing of the DG set depends on the Load demand and the demand for DG auxiliaries. Load demand is the useful power available to the load. The capacity of DG set should be such that nominal efficiency occurs at the load combining both load demand and DG auxiliary demand.

During selection, the de-rating of capacity due to factors like ambient conditions, altitude, etc has to be considered to determine the capacity requirement of the engine for a specified load.

b) Minimum Generator set Load/Capacity

Running a generator set under light load can lead to engine damage, reducing generator set reliability. Therefore, operating generator sets at less than 30 percent of rated load is not recommended. Load banks should supplement the regular loads when loading falls below the recommended value

c) Altitude and Temperature

Based on the site location, the size of the generator set must increase for a given level of performance as altitude and ambient temperature rise. Altitude will cause a serious de-rating of the prime mover to deliver the torque required for the full generator output. Over sizing of

the engine is a must for higher altitudes. The generators are less critical in output capacity if adequate cooling air is supplied to carry away the heat generated by the losses.

Table 2.1: Altitude and Intake Temperature Corrections

Environmental factors	Effects
Altitude	Create problem with generator startup, less heat dissipation resulting in high engine temperatures
Temperature	Overheating of engines due to inadequate oxygen levels available for combustion at lower air density
Humidity	Ignition problem

Duty cycle and prime power rating

Generator set size is also influenced by whether the application is for standby power, prime power or utility paralleling. Standby power systems generally have no overload capability. Prime power systems generally have a minimum of 10 percent overload capacity. Generator sets that are intended to operate extended hours at steady constant load should not be operated in excess of the continuous rating.

Correction Factors For Engine Output				
Altitude Correction			Temperature Correction	
Altitude Meters over MSL	Non Super Charged	Super Charged	Intake °C	Correction Factor
610	0.980	0.980	32	1.000
915	0.935	0.950	35	0.986
1220	0.895	0.915	38	0.974
1525	0.855	0.882	41	0.962
1830	0.820	0.850	43	0.950
2130	0.780	0.820	46	0.937
2450	0.745	0.790	49	0.925
2750	0.712	0.765	52	0.913
3050	0.680	0.740	54	0.900
3660	0.612	0.685		
4270	0.550	0.630		
4880	0.494	0.580		

In general building applications, the DG set can be designed for standby power rating. Standby Rating is applicable to installations served by a utility source. A standby rating is applicable to varying loads for the duration of power outage. There is no overload capability for this rating. This rating is in accordance with ISO-8528/1, overload power in accordance with ISO-3046/1 BS5514, AS2789 and DIN 6271.

In case of Datacenter applications, the DG has to be designed for prime power rating. Prime power rating is applicable for supplying electric power in lieu of commercially purchased power. Prime power is the power available at variable load for an unlimited number of hours. A 10% overload capacity is available at intermittent periods. Rating is in accordance with ISO-8528/1, overload power in accordance with ISO-3046/1 BS5514, AS2789 and DIN 6271.

d) Specific fuel consumption / Fuel economy

Specific fuel consumption (SFC) is a measure of fuel efficiency within a reciprocating engine. It is the ratio of fuel consumption to the power produced. SFC allows the fuel efficiency of different reciprocating engines to be directly compared.

$$\text{Specific fuel consumption (SFC), grams/kWh} = \text{Fuel rate (kg/hr)} / \text{Power Generation(kW)} \times 1000$$

Where,

Fuel rate is the fuel consumption in grams per second (g/s)

Power is the power produced in Watts where $P = T\omega$

ω is the engine speed in radians per second (rad/s)

T is the engine torque in Newton meters (Nm)

Commonly SFC is expressed in units of grams per Kilowatt-hour (g/kWh).

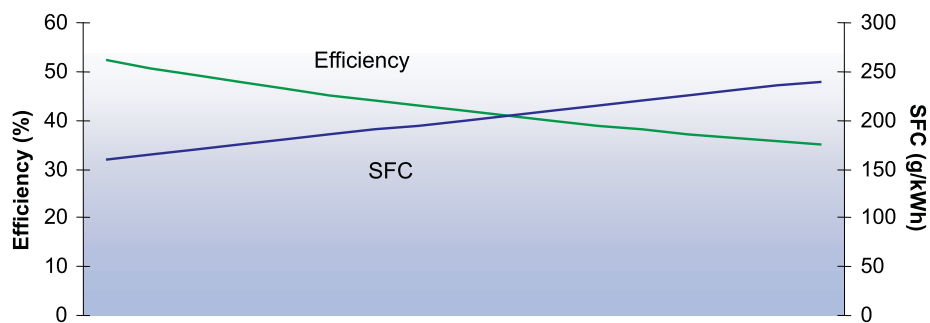

Figure 2.3: Illustration of SFC and efficiency relation

$$\text{Diesel engine efficiency} = 1 / (\text{SFC} \times 0.0119531)$$

Where,

$$\begin{aligned} \text{Lower heating value for Diesel fuel} &= 18500 \text{ BTU/lb} \\ &= 0.0119531 \text{ kWh/gm} \end{aligned}$$

Therefore, low specific fuel consumption means higher engine efficiency.

e) Load power factor

Leading power factor current can destabilize the DG set, therefore utmost care should be taken to ensure the load power factor supported by Generator.

A generator set can carry up to 10 percent of its rated kVAR capability in leading power factor loads without damaging or losing control of output voltage. The most common sources of leading power factor are lightly loaded UPS systems with input filters and power factor correction devices for motors.

f) Special considerations

Unusual conditions of altitude, ambient temperature, or ventilation may require either a larger generator to hold down winding temperatures or special insulation to withstand higher temperatures. Generators operating in the tropics are apt to encounter excessive moisture, high temperature, fungus, vermin, etc., and may require special tropical insulation and space heaters to keep the windings dry and the insulation from deteriorating.

g) Automatic systems

In order for engine-driven generators to provide automatic emergency power, the system should also include automatic engine starting controls, automatic battery charger, and an automatic transfer device. In most applications, the utility source is the normal source and the engine-generator set provides emergency power when utility power is interrupted or its characteristics are unsatisfactory. The utility power supply is monitored and engine starting is automatically initiated once there is a failure or severe voltage or frequency reduction in the normal supply. The load is automatically transferred as soon as the standby generator stabilizes at rated voltage and speed. Upon restoration of normal supply, the transfer device automatically retransfers the load and initiates engine shutdown.

Some energy saving measures for DG sets

- Ensure steady load conditions on the DG set, and provide cold, dust free air at intake (however, in case of dry, hot weather, use of air washers for large sets can be considered)
- Improve air filtration
- Ensure fuel oil storage, handling and preparation as per manufacturers' guidelines/oil company data
- Calibrate fuel injection pumps frequently
- Ensure steady load conditions, avoiding fluctuations, imbalance in phases, harmonic loads
- In case of a base load operation, consider waste heat recovery system adoption for steam generation
- Consider parallel operation among the DG sets for improved loading and fuel economy thereof

2.4.0 Transformer

Utility transformer voltage rating is determined based on size and spread of the Datacenter, though loads are single phase and LT in nature.

Transformer is the gateway for the power to the Datacenter

The following factors have to be considered during selection and operation of the transformers.

2.4.1 Harmonics and K - Factor transformer

Nonlinear loads generate harmonic currents, which flow from the load toward the power source following the paths of least impedance. Harmonic currents are currents of multiple fundamental frequencies. The harmonic currents flowing through the power system impedances result in harmonic voltage drops, which are observed as harmonic voltage distortion. Very severe voltage distortion can result when the power system inductive reactance equals the capacitive reactance at one of the harmonic current frequencies (typically the 5th, 7th, 11th or 13th harmonic), known as parallel resonance.

Transformers are vulnerable to overheating and premature failure due to harmonic currents generated by nonlinear loads. To protect against transformer overheating caused by harmonics, designers consider de-rating of equipment, i.e., oversized transformers which will run at a fraction of the rated capacity. Such transformers are called as K-factor transformers, which is specifically designed to accommodate harmonic currents. K-factor transformers are preferred because they have additional thermal capacity of known limits, design features that minimize harmonic current losses, and neutral and terminal connections sized at 200% of normal capacity. K-factor transformers allow operation up to nameplate capacity without de-rating.

K-factor

K-factor is a value used to determine how much harmonic current a transformer can handle without exceeding its maximum temperature-rise level

$$\text{K Factor} = \frac{\text{Additional losses due to harmonics}}{\text{Eddy current losses at 50 Hz}}$$

2.4.2 K-rated transformer

The K-Value of the transformer is determined based on the percentage of non-linear load in the electrical system. The typical K-value and its percentage non-linear load is tabulated below.

K-value	Harmonic non-linear load %
K-4	50%
K-13	100%
K-20	125%
K-30	150%

Generally for non-linear loads and computer rooms, the recommended K-factor of the transformer is 4 to 9.

2.5.0 Transfer switch arrangement

An automatic transfer switch enables redundant UPS, backup generators, DC to AC inverters, or other AC power sources to be used for a single load.

Automatic Transfer Switches (ATS) are recommended when no downtime from a power outage is tolerated

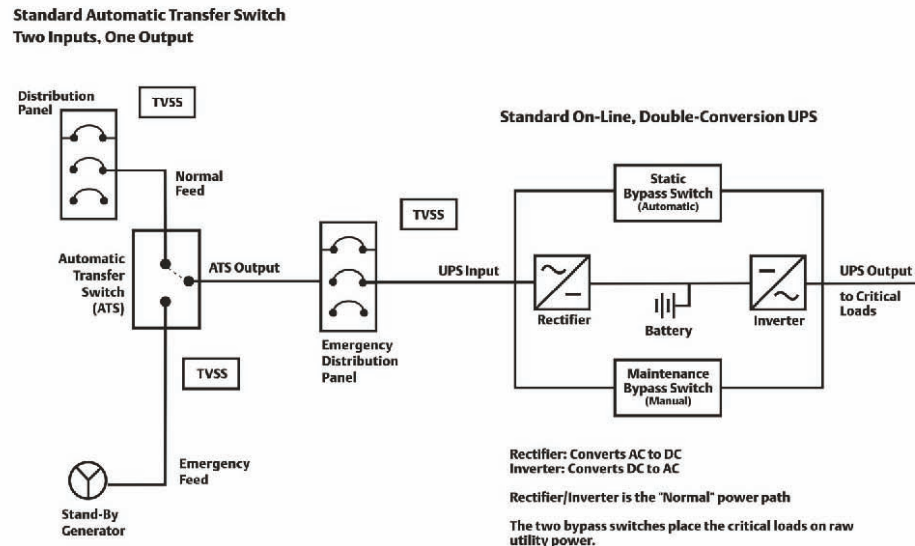

Figure 2.4: Schematic of Automatic Transfer switch Arrangement

Controlling power transfer operation automatically and accessing accurate data in real time are essential elements of effective onsite power for Datacenters.

As per IEEE 1100 – 2005 standards recommended practice for emergency and Standby systems with electronics load equipments to be designed as per IEEE STD 446TM. i.e, means of achieving interconnection of Prime and back-up AC supply source via transfer switches. This recommended practice clarifies the very important issue surrounding the grounding and interconnection of the grounded circuit conductor of two AC systems those are to be switched between systems such as a UPS system, engine-drive generator, or both.

The Preferred configuration for three-phase system serving electronic load equipment is the use of three-phase, 3 wire circuits serving three-pole transfer switches, which in turn feeds isolation transformers (or other Power conditioners that meet the requirements of a separately derived system) located as close as practicable to the electronic load equipment. When serving 4 wire loads directly the preferred arrangement is the use of four-pole transfer switches with an overlapping neutral pole to maintain the generator as a separately derived source and simplify any ground-fault protection schemes.

The application of four-pole transfer switch is satisfactory when the loads are passive and relatively balanced. However, unbalanced loads may cause abnormal voltages for as long as 10-15 ms when the neutral conductor is momentarily opened during transfer of the load.

Transfer switches may be called upon to operate during total load unbalanced caused by a single-phasing condition. Inductive loads may cause additional high transient voltages in the micro sec. to arcing the contact erosion. A good maintenance program is recommended to reaffirm at intervals the integrity of the fourth pole as a current-carrying member with sufficiently low impedance.

The automatic transfer switches and accessories shall conform to the requirements of:

- A. UL 1008 - Standard for Automatic Transfer Switches
- B. NFPA 70 - National Electrical Code
- C. NFPA 110 - Emergency and Standby Power Systems
- D. IEEE Standard 446 - IEEE Recommended Practice for Emergency and Standby Power Systems for Commercial and Industrial Applications
- E. NEMA Standard ICS10-1993 (formerly ICS2-447) - AC Automatic Transfer Switches

2.6.0 Transient Voltage Surge Suppressor (TVSS)

A Transient voltage surge suppressor is an appliance designed to protect electrical devices from voltage spikes.

A surge protector attempts to regulate the voltage supplied to an electric device by either blocking or by shorting to ground voltages above a safe threshold

Electrical Power Line disturbances such as high voltage transients can disrupt or damage sensitive electronic equipment causing a major loss in terms of productivity and money.



Figure 2.5: Voltage transients

Over-voltage conditions can either be of a transient nature or steady-state nature. During transient over-voltage conditions, both the magnitude and the frequency are higher for a small duration. During steady-state over-voltage conditions, the magnitude is higher than the normal supply voltage for a longer period of time or even continuously while the frequency is the same as supply voltage.

Protection from over-voltage conditions is necessary to preserve the quality of the insulation

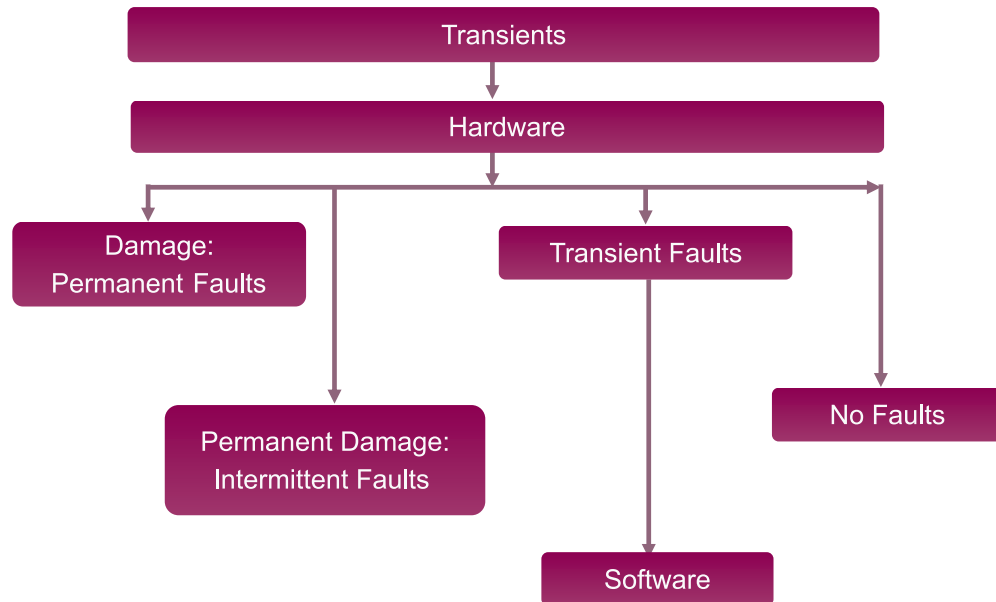

Figure 2.6: Transients and their possible effects on programmable electronics

IEEE recommends the use of TVSS both in:

- › The input circuit to the UPS
- › The associated bypass circuits (including the manual bypass circuit)
- › The connected branch panel

A high-energy transient entering the electrical System through the service entrance would be clamped at the UPS and then again at the branch panel in order to provide the best protection to the critical loads in the downstream of the electrical network.

Table 2.2: TVSS Ratings

RMS SYSTEM Amps	TVSS RATING
Above 3001	300 – 400 kA TVSS
3000 – 2001	200 – 300 kA TVSS
2000 – 1201	150 – 200 kA TVSS
1200 – 601	100 – 150 kA TVSS
600 – 226	100 – 130 kA TVSS
225 – 126	50 – 100 kA TVSS
125 – 60	25 – 50 kA TVSS

Source : International Surge Suppression Guide

Large surges of the magnitude up to 100KA or above can destroy the equipment completely. Surges pass through all copper lines within the premises including power lines, data lines or any other communication lines.

Surges are produced both externally and internally.

For example:

- › During switching operations in the electrical systems
- › Conductor loop formation from the conductors, from the mains supply and data transmission
- › Erratic Power Supply from the source / substation
- › Lightning discharges (Direct / Indirect) in the vicinity of installations

Based on the study, $\frac{3}{4}$ th of all power disturbances are caused by equipment inside your building. In fact, any device that runs in cycles or gets turned on and off frequently can cause cumulative and equally damaging power hazards. Even something as small as copier or a laser printer can cause problems in sensitive equipment that share the same line.

Transient voltage surge suppressor (TVSS) shall be installed at all levels of power distribution system as shown in figure 2.7.

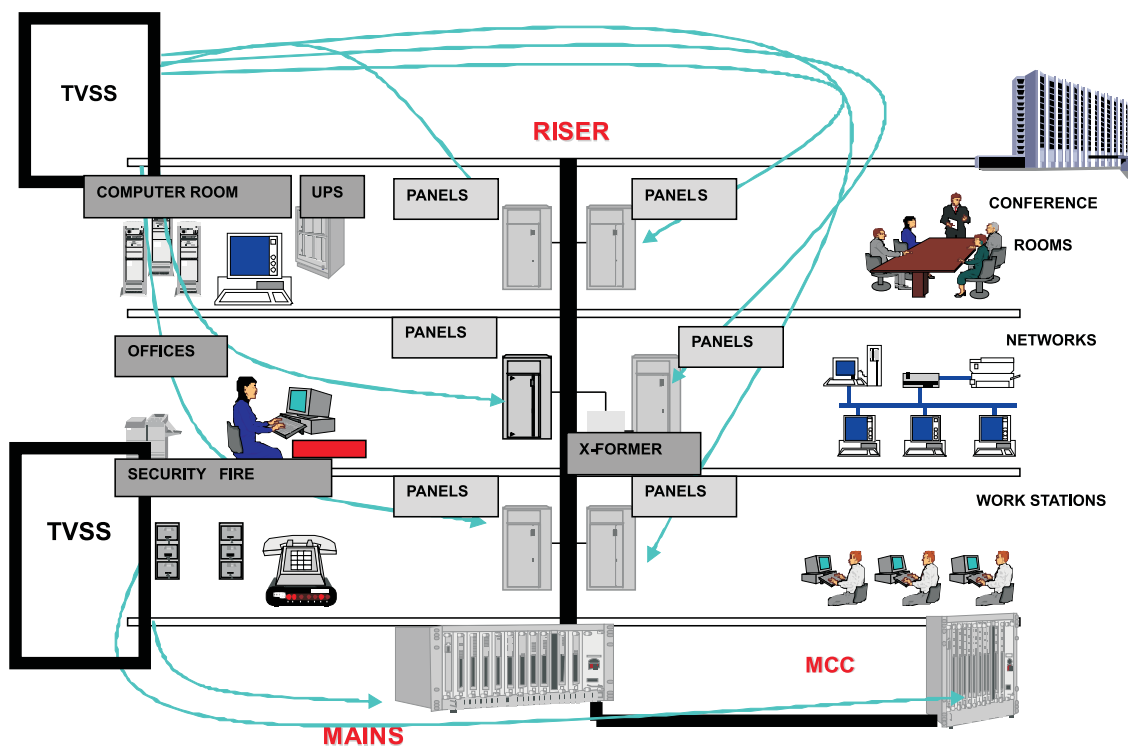

Figure 2.7: TVSS For Multistory Building shows the possibilities where TVSS is required

Transient voltage surge suppressor shall necessarily have following specs:

- › The voltage rating shall be 800Vp for all modes L-L, L-N, L-E, N-E
- › All mode protection
- › Maximum Continuous Operating Voltage (MCOV) rating of minimum 320Vrms.
- › Response time of the TVSS components shall be 0.5 nanosec
- › All TVSS components shall be fused and encased in Silica Quartz Sand
- › The TVSS shall be constructed of metal oxide variastor (MOV) technology and internal surge
- › Capacitance & shall provide filtering minimum 40dB (noise attenuation)

As per IEEE standards, it is a recommended practice that both the input circuit to the UPS and the associated bypass circuits (including the manual bypass circuit) be equipped with effective Transient Voltage Surge Suppression (TVSS)

The selection of surge suppressor depends upon the following points:

- › Surge Handling Capacity or Arrester Rated Voltage
- › Maximum Continuous Over Voltage (MCOV)
- › Response Time
- › Protection Level
- › Fault Current Rating
- › Status Indication (Monitoring)
- › Certifications
- › Reliability

TABLE 2.3: TVSS Selection Chart

Sr. No.	Application Load	Protection Mode	Surge Current Capacity	Fault Current Rating
	MDB / DB / SDB	All Mode /Two Mode	(kA)	(kA)
1	<u>2000 & Above</u>	<u>L-L/L-N/L-G/N-G (All Mode)</u>	400 kA / 500 kA – 1000 kA	200 kA
2	<u>1000 & Above</u>	<u>L-L/L-N/L-G/N-G (All Mode)</u>	250 kA / 300 kA / 400 kA	200 kA
3	<u>500 – 1000 Amp.</u>	<u>L-L/L-N/L-G/N-G (All Mode)</u>	160 kA / 200 kA	200 kA
4	<u>200 – 500 Amp.</u>	<u>L-L/L-N/L-G/N-G (All Mode)</u>	130 kA / 160 kA	200 kA
5	<u>100 – 200 Amp.</u>	<u>L-L/L-N/L-G/N-G (All Mode)</u>	100 kA / 160 kA	14 kA / 65 kA
6	<u>50 – 100 Amp.</u>	<u>L-L/L-N/L-G/N-G (All Mode)</u>	50 kA / 100 kA	14 kA
7	<u>25 – 50 Amp.</u>	<u>L-L/L-N/L-G/N-G (All Mode)</u>	25 kA / 50 kA	14 kA
8	<u>10 – 25 Amp.</u>	<u>L-N / N-G (Two Mode)</u>	25 kA	14 kA

2.6.1 Benefits of Transient Voltage Surge Suppressor

- › Transient Surge Suppressor reduces exposure of equipment to damaging surges.
- › Reduces erratic CPU operation, memory loss, and aggravating nuisance reboots

- › Continuous Protection. No labor or time involved
- › Increased survivability. Long life expectancy
- › Reacts to transients before they reach load equipment. Lower let-through voltage
- › Consistent performance and durability. Extends component life and prevents adverse effects from environmental factors

2.7.0 Distribution board

The Primary function of the switchgear in a mission critical power system is electrical power distribution throughout the facility. However, switchgear also provides an important function of protecting the system from electrical faults upstream and down stream of the UPS.

2.7.1 Key functions of Switchgear

- › Provide electrical power distribution for the critical systems
- › Utilization of power bus and circuit breakers through multiple paths
- › Provides isolation and protection
- › Circuit breaker and alternative power paths allow for continuous operation
- › Protects the systems from electrical faults
- › Provide physically and electrically isolatable components and alternative / bypass power paths for safe and reliable maintenance procedures
- › Provide voltage and current sending points for performance monitoring equipments

2.8.0 Uninterrupted Power Supply (UPS) System

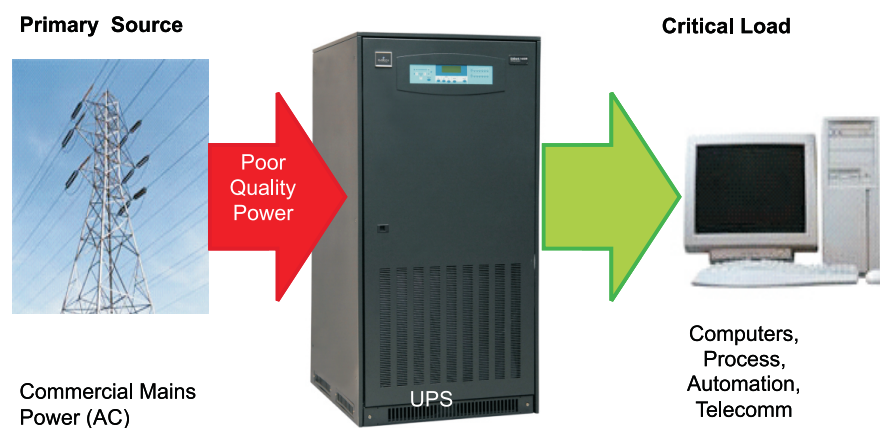

Figure 2.8: UPS as a load and Power Sources

The Uninterruptible Power Supply is the heart of any critical power infrastructure. The UPS provides the primary protection from harmful power disturbances as well as gives a linkage to stored energy source or alternative power sources during times of outage. Figure 2.8 shows the basic function of a UPS. AC power, poor in quality, flows from the primary source i.e the

commercial mains supply. The UPS, acting as both a load and a source, transforms this poor-quality power to high-quality power, which can then be safely applied to critical loads.

Commercial Power containing spikes, sags, and outages would cause data loss and severe damage to IT infrastructure in a Datacenter. An Uninterruptible Power Supply (UPS) is used to protect Datacenters from an unexpected power disruption which would cause data loss resulting in disastrous consequences for the company

The UPS has a battery back-up system which provides emergency power until an auxiliary power supply is turned on, or the utility power is restored, or the equipment is shut down safely

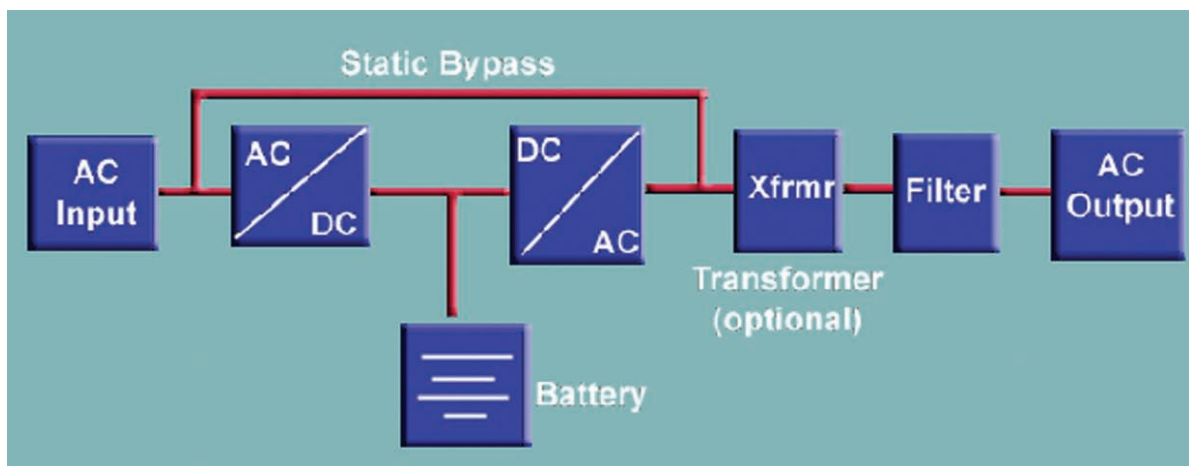

Figure 2.9: Typical Schematic diagram of Uninterruptible Power Supply

The UPS is one of the most critical pieces of equipment in a Datacenter. Typically, online UPS systems are used in Datacenters. These systems are ideal for environments where electrical isolation is necessary or the equipment in use is highly sensitive to power fluctuations.

The number of UPS systems to be used for a particular Datacenter depends on the Tier level of the Datacenter and also on the significance of the process

Traditionally, the selection of UPS systems has focused on system reliability without giving much thought to the system efficiency. However, with the increase in energy costs and as a consequence of the energy shortage situation, the efficiency of the UPS system has now become a major consideration, while reliability still remains as the topmost criteria.

In order to have redundancy level in a Datacenter, the number of UPS systems is increased. This

UPS system efficiency, as for any other electrical equipment, depends on the loading

eventually leads to decrease in the loading of UPS systems.

The Loading vs. Efficiency curve is shown in the Figure 2.10. The curve shows that, in most cases, the operating efficiency of the UPS system reduces due to lower load on the UPS.

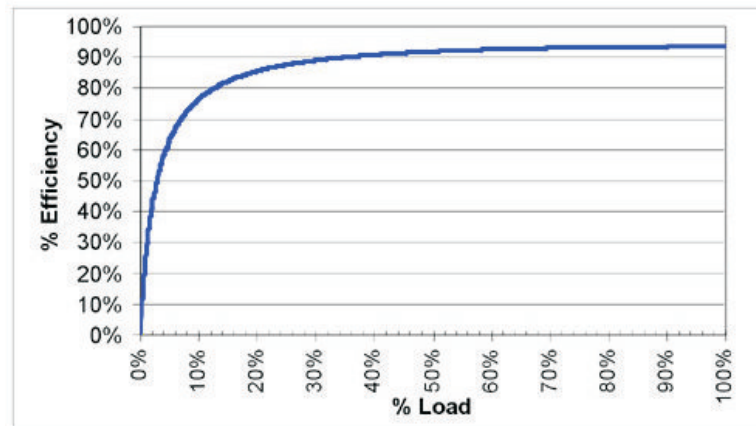

Figure 2.10: Loading versus. Efficiency Curve for a UPS

The change in efficiency with varying load has another important effect on the interpretation of operating efficiency. Consider the case of the two Datacenters being compared in Figure 2.11.

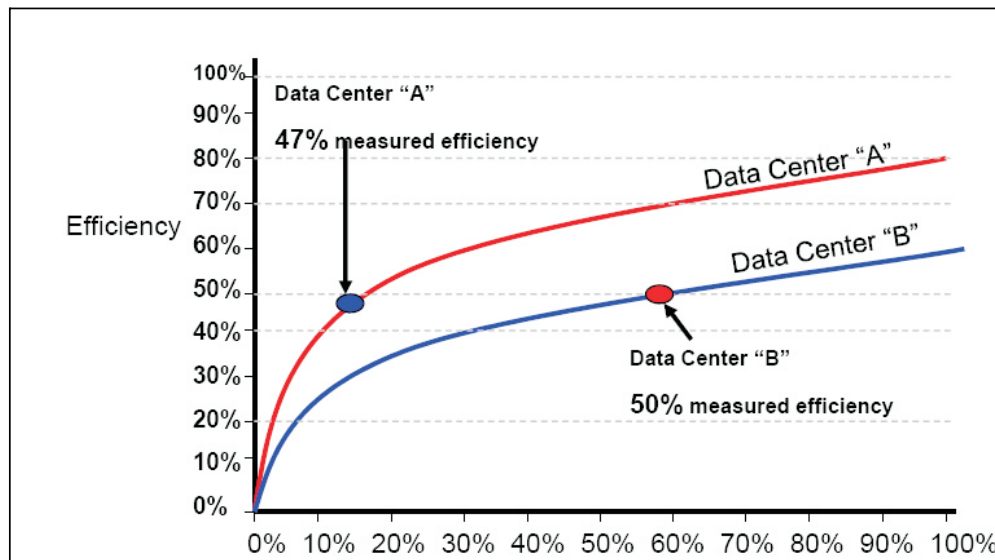

Figure 2.11: Comparison of the efficiency curves vs IT load for two different Datacenters

Datacenter A appears to have the better design efficiency and it may seem reasonable to assume that it is a “Greener” Datacenter of fundamentally superior design. However, consider the detailed view of these two Datacenters as shown in Figure 2.11, the design efficiency of Datacenter A is higher than that of Datacenter B. Nevertheless, the operating efficiency of Datacenter A is lower than that of Datacenter B if Datacenter A faces only 14% loading and Datacenter B faces 58% loading. The Low operating efficiency is due to a low percentage load

on the IT equipment and therefore on the overall infrastructure.

Low operating efficiency is due to the following reasons

- › Varying load requirements with respect to time
- › Over-sizing of equipment by design
- › Installation of multiple equipment to facilitate higher redundancy level

Various techniques are available to optimize the loading of the UPS system and to optimally share the load on all the UPS systems. Modularity is one such method to improve the efficiency of the UPS system. Modularity allows users to size the UPS system as closely with the load as practical (in other words, it allows the UPS to operate as far right on the curve as possible).

UPS technologies continue to evolve towards greater electrical efficiency and the newer technologies available will yield greater benefits.

2.8.1 UPS Topologies

There are three basic types of UPS System, depending on which further configurations can be made

- › Offline System / Stand by System
- › Line Interactive System
- › On-line System / Double Conversion System

➤ Offline UPS: (Passive standby)

This system energizes the load directly from the utility mains. It contains a charger and an Off- Line Inverter. The Inverter is switched ON upon mains outage to supply the load as shown in figure 2.12.

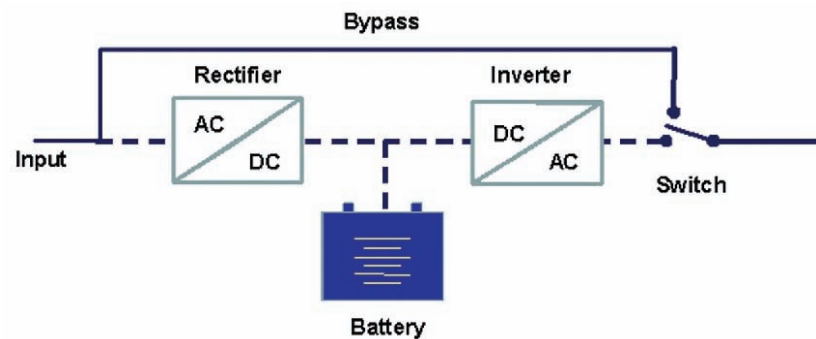

Figure 2.12: Block Diagram of Off Line UPS System

➤ Line interactive :

During normal operation Mains Supply is extended to load. "Converter / Inverter Section" acts as a "Charger" which maintains battery in charged condition. During a power failure the "Converter / Inverter Section" acts as "Inverter" which utilizes energy stored

in battery to feed load as shown in figure 2.13.

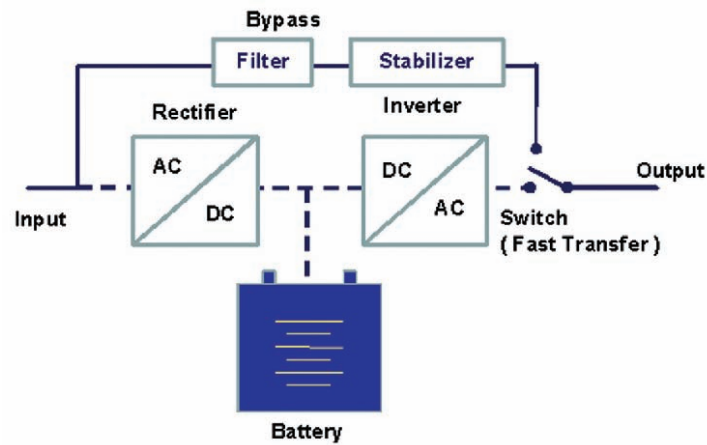

Figure 2.13: Line interactive UPS Configuration

➤ **Online double conversion:**

(True on line): A double conversion system, which energizes the load continuously from the inverter. The inverter is fed from mains via a rectifier in normal operation, or from batteries upon mains outage.

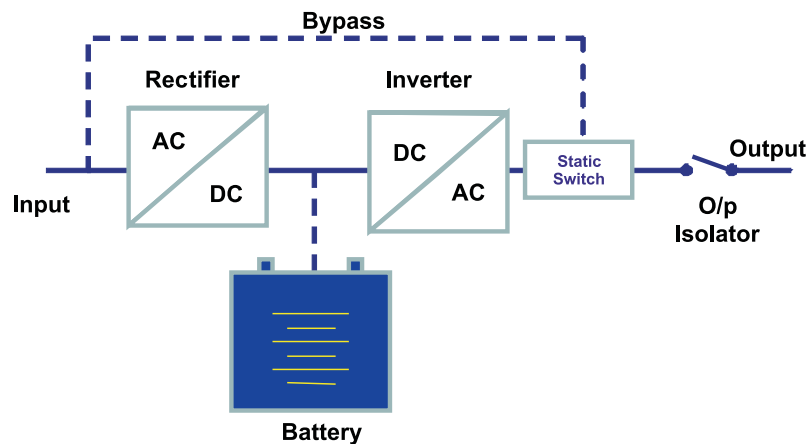

Figure 2.14: On-Line Double Conversion UPS Configuration

Out of all the above UPS topologies, the Online Double conversion transfer topology is the only one that protects against the full range of power disturbances and is recommended for applications that are currently mission-critical or expected to become mission-critical, which includes virtually all Datacenters. Selecting an online double-conversion UPS ensures that availability requirements will not outgrow UPS topology.

2.8.2 Selection criteria

Compliance to established international guidelines, codes and standards : IEC 62040, IEC 146, IEEE 1100, other IEEE/IEC/EN/ANSI Codes and guidelines for UPS Modules and Batteries, DIN

41772 (Rectifier adequacy for Battery Charging), IEC62040-3 for Performance Measurement Criteria, UL Listing for TVSS and ATS.

- Optimal Redundancy and Minimised Common Point of Failures in order to meet User's Tier Level, criticality and Availability needs
- Optimal Galvanic Isolation of Supply Phases and Neutrals
- Design adequacy towards Safety of human and machine
- Optimal & Adequate Sizing of all components
- Compatibility with source and Load

Energy conservation considerations such as : Energy Optimisers, Adequate filtration for KW-KVA Parity, Intelligent Battery Management, AC-AC Efficiency, heat loads and need of air conditioning,

The Watch word here is doing the selections "Just optimally"... one should not either underdo it (Which may lead to compromised design, nagging failures, reliability and safety question marks) or overdo it (Which will lead to higher consumption of Energy).

2.8.3 UPS configuration

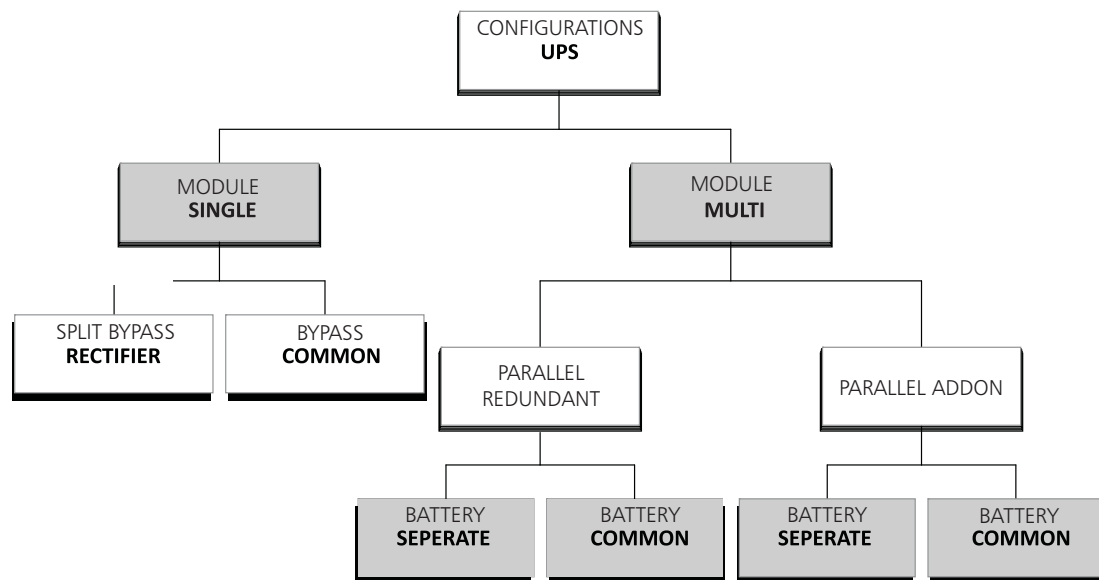

Figure 2.15: UPS Configurations

2.8.4 High availability power system

The computing industry talks of availability in terms of « Nines ». This refers to the percentage of time in a year that their system is available, on-line, and capable of doing productive work. A system with four “Nines” is 99.99% available, meaning that downtime is less than 53 minutes per year. Five “Nines” (99.999% available) equates to less than 5.3 minutes of downtime

per year. Six “Nines” (99.9999% available) equates to just 32 seconds of downtimes per year.

Improving Availability means improving MTBF and/or reducing MTTR. This will not yield the significant improvement truly critical operations need to go beyond 99.9999%.

2.8.5 Determination of availability

$$\text{Availability} = \text{MTBF} / (\text{MTBF} + \text{MTTR})$$

MTBF (Mean time before failure) = increased Reliability

MTTR (Mean Time between Repair) = Fast Recovery

MTBF (Mean Time between Failures)

The reliability of the Datacenter is inversely proportional to the time taken between failures.

- 37% chance of still working

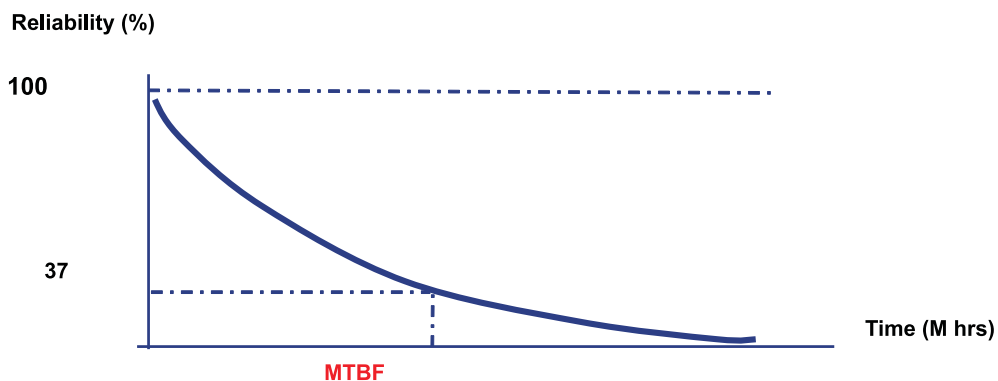

Figure 2.16: Graphical Representation of MTBF

MTTR (Mean Time to Repair)

- 63% chance of having been repaired

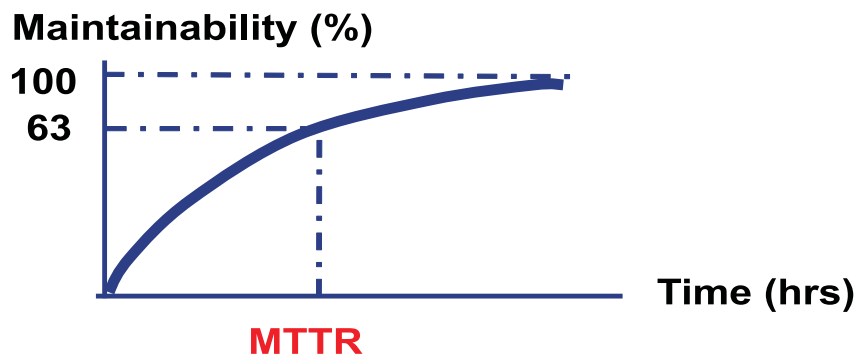

Figure 2.17: Graphical Representation of MTTR

Calculation to improve availability by paralleling UPS system for Redundancy

❖ For Paralleled Systems,

$$\text{MTBF} = \text{MTBF1} + \text{MTBF 2} + ((\text{MTBF1} \times \text{MTBF2}) / (\text{MTTR}))$$

2.8.6 UPS efficiency

Today it is both possible and prudent to plan, measure, and improve Datacenter efficiency. In addition to reducing electrical consumption, efficiency improvements can give users higher IT power densities and the ability to install more IT equipment in a given installation.

2.8.7 Rotary and Battery-Less UPS system

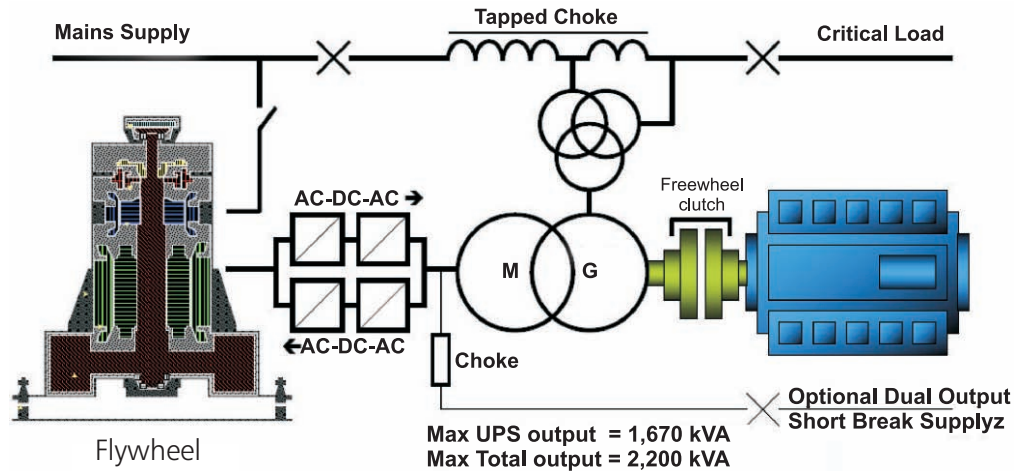

Figure 2.18 a: Schematic of Rotary UPS system

There are two distinct variants of Battery-Less UPS. One which uses a Static UPS combined with Flywheel plus Flywheel converter as shown in Figure 2.18 (a) below. Flywheel plus Converter acts as alternative to the Batteries. In this case, during Utility Power supply outage the Kinetic energy of Flywheel-rotation gives the backup / ride-through to the Inverter for a few seconds till the Generator is energized and connected to the Rectifier. The second one as shown in Figure 2.18 (b) below which uses a Rotary Motor-Generator Set-up coupled with a Diesel / Natural Gas Engine through a Clutch arrangement and a Flywheel plus AC-DC-AC Converter (which is a Static Element). This is, therefore, also known as a Hybrid UPS since it actually uses a combination of Rotary and Static Elements. Both the above variants leave option for connection of Batteries also. While the Flywheel provides a ride-through of a few seconds upon Utility failure, the Engine starts and connects through the Clutch meanwhile, maintaining the rotational energy to the generator which in turn maintains the Power Supply to the Loads.

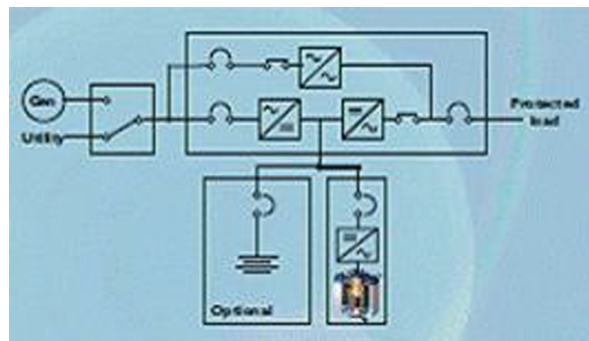

Figure 2.18 b: Schematic of a Flywheel based Static UPS

Advantages and disadvantages of Batteryless / Rotary UPS systems

Advantages

- Being Battery-Less, design restrictions associated with specific Batteries are overcome
- Rotary / Hybrid System due to its low impedance have superior fault clearing capability
- Capable of supplying high-inrush loads such as transformers /motors/inductive loads
- Rotary / Hybrid system when operating from Utility Power Supply has higher efficiency compared to Static Unit
- Rotary System, if operated directly through the Motor-Generator Set, has much lower current harmonic distortion
- It is particularly energy saving for applications where Utility Supply Interruption is less than about 750 outages per year and each interruption does not exceed 3-4 second

Disadvantages

- Rotary/Hybrid UPS using Diesel Engine are associated with Engine malfunctioning and failure facing high block-loads. Engine needs early replacement
- Rotary/Hybrid UPS using Diesel Engine are associated with nagging Clutch failure and frequent replacements when used in Indian conditions having 2 or more outages per day. The clutch is designed for finite life of about 750 operations per year
- Flywheel based Static UPS heavily depends on fast starting-up and synchronizing of the backup Generator within few seconds. If power demand requires multiple number of backup generators to be synchronized, this system interrupt supply to load/equipment if generator output fails to come up in time
- In flywheel based Static UPS of Higher KVA Ratings, trying to achieve ride-through/backup of >9 secs requires paralleling and synchronous running of 4-5 Flywheels. Speed variation between individual Flywheels may cripple system reliability

2.9 Power Distribution Units

The distribution of power to the IT load is done through power distribution units (PDU). The schematic representation of the power distribution from the UPS to the IT load through the PDU is shown in Figure 2.19.

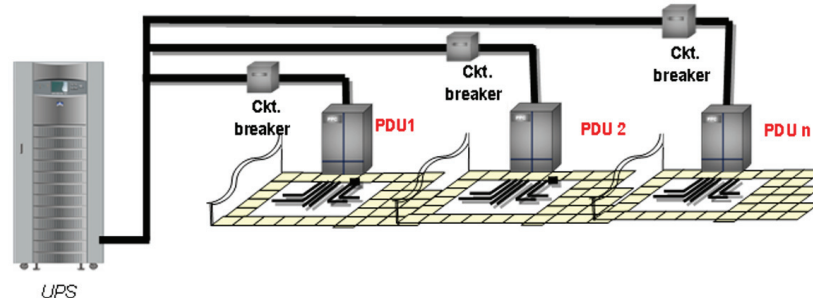

Figure 2.19: Diagram of Power Distribution from the UPS to the IT load through the PDU

To maintain high levels of redundancy, two or more PDUs are provided to distribute power to each of the server racks. In the case of a failure of any one of the PDUs, the distribution of power would be taken by the other PDUs present in the loop and thus uninterrupted power supply to the server racks.

The traditional PDU architecture, which had severely shortened the capacity expansion ability of a Datacenter, have been replaced with modular power distribution units, which has certain inherent properties which makes it superior to the conventional PDUs.

2.9.1 Challenges faced with traditional PDUs

- › Traditional PDUs require many receptacles as Datacenters typically have a large number of plug-in devices with separate power cords
- › The modern high density IT servers have different power requirements and/or receptacle requirements at the rack location
- › The changing power requirements would require the addition of new power circuits, which have to be added to the live Datacenter without disturbing existing IT loads
- › Obstruction of air-flow to the IT equipment by the power cords in under-floor air plenum

The above challenges can be addressed using modular power distribution design.

2.9.2 Modular Power Distribution Unit (PDU)

The power distribution unit includes a frame, and one or more user-replaceable power modules that fit into slots in the frame. Each power module has one or more plug receptacles to provide power to the equipment connected. The power modules are available in a variety of receptacle types, receptacle numbers, and power rating configurations to accommodate the equipment in a particular environment as required.

The frame includes an internal connector panel for distributing power from a power source to the power modules inserted in the frame. The power modules may be removed, installed, and interchanged in the frame without interrupting power to other power modules or to the power distribution unit.

An ideal power distribution system would have the following attributes:

- New circuits can be added or changed on a live system
- No under-floor cables are needed
- All circuits can be monitored
- Capacity and redundancy can be managed on every circuit
- The system is highly efficient

The power distribution system with a Modular Power Distribution unit is shown in Figure 2.20.

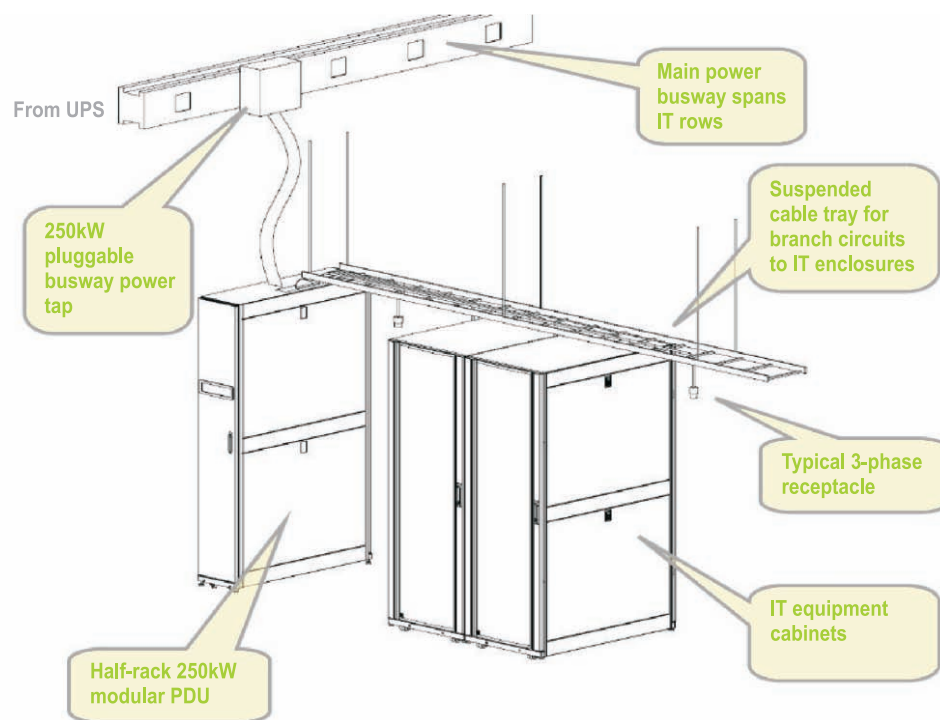

Figure 2.20: Schematic of Modular Power Distribution System [Source: APC]

Benefits of the modular architecture

- Retrofit is easy
- Minimized air blockage in under floor since it uses suspended cable trays for distribution
- The architecture facilitates easy modification of power distribution which helps quick reconfiguration of rack power

2.10 Static switch

Static Transfer switches (STS) secure the critical application using two independent power sources. They protect load against source failure, inadvertent tripping of upstream protections. Consequences of mutual disturbances cause by faults in the other equipment supplied by the same source.

Seamless transfer of load between sources should be possible when two sources have frequency and phase angle matching. Static Transfer switches would inhibit transfer of load due to downstream fault to the alternative source thus, maintaining high uptime.

Benefits of STS

- Static Transfer Switch eliminates the risk of transformer saturation problems during automatic transfers
- Control (patent-pending) ensures minimum voltage disturbance during transfers while still balancing the flux
- Standard design – 4ms transfer - Secondary side, 208V, switching
- Optional Optimized Transfer - Primary side, 480V / 600V, switching - Out-of-phase transfers

2.11 Advanced power strip

Advanced power strips are designed to distribute and manage power within network cabinets and server racks. They have provision for remote monitoring and / or control capabilities for power distribution at the load / Equipment level.



Figure 2.21: Advanced Power Strip

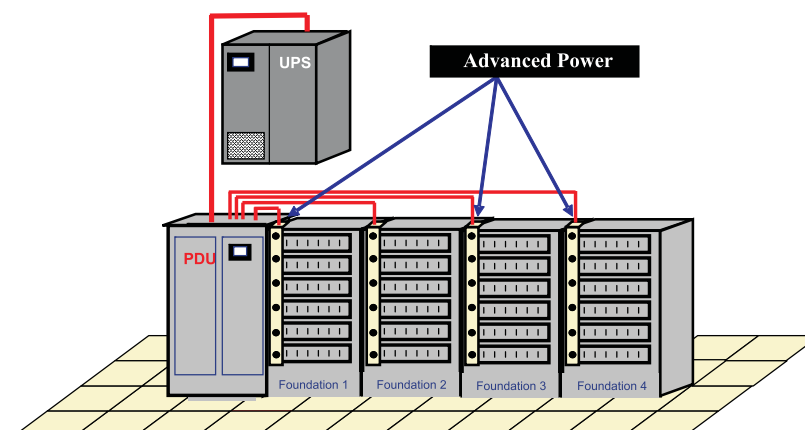

Figure 2.22: Advanced Power Strips connected on Racks

Benefits of Advanced Power Strips

- › Protection against Inadvertent overloading
- › Can monitor & control high Electrical load densities
- › Load Monitoring and Control
- › High Reliability
- › True Power Monitoring

2.12 Energy saving opportunities in Electrical systems

This section briefly discusses various energy saving opportunities in Datacenter electrical systems. The following energy saving techniques are supported by the case studies/write-ups detailed later in the section.

Energy saving measure 1: Optimizing the loading on the UPS and PDU systems

The Datacenter facility managers maintain certain redundancy levels to sustain site operations as required. However, some Datacenters are operated with more redundant systems than recommended.

Increase in redundancy compromises the operating efficiency of the system

The operation of the modules can be controlled so that the units operate at a higher load factor. This would result in better operational efficiency. The details of the project demonstrating this concept are discussed in Case Study No. 2.

The efficiency of the UPS system varies with loading. Typically, an UPS system has maximum efficiency at 75-80% loading. When loading is less than 40-45%, the efficiency reduces drastically.

It is recommended that the UPS loading be maintained at more than 40%

Energy saving measure 2: Using energy optimizer

Enabling dynamic source adaptability to load requirement would result in optimal operating range, and reduce energy costs, compared to using a static source installation model.

An Energy Optimizer is a device which senses the load demand continuously and controls the operation of the number of UPSs at any point of time, and also maintains optimum loading on all UPS

Redundancy levels and sequencing operation are some of the features which can be set based on user requirement. The schematic representation of an Energy optimizer connection to the UPS system is shown in Figure 2.23.

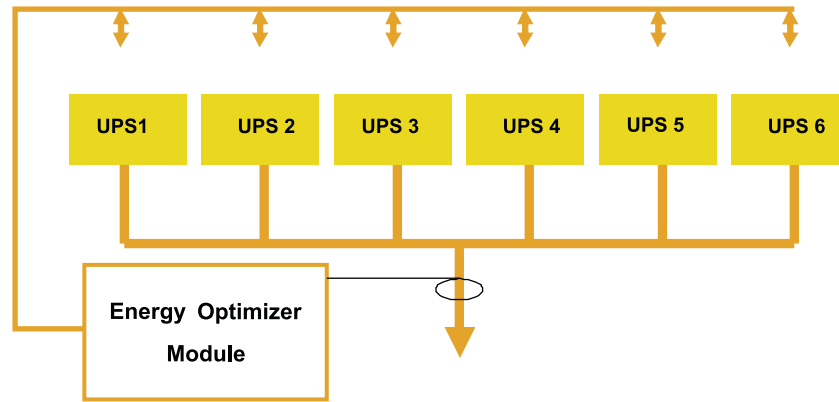

Figure 2.23: Energy Optimizer connected to UPS system

Energy Optimizer senses the load demand continuously and intervenes to maintain required number of UPS systems operating at any given point of time. Redundancy levels and sequencing operation can be set in the optimizer.

UPS system no load loss were significant compared to the actual load loss on each UPS.

For example, Night and Weekend/off day loads may be quite different from regular daytime load. All the factors mentioned above asserts a simple fact that UPS systems are being loaded way below its optimal bandwidth of performance.

It is a well-known fact that the best operating efficiency of the system of any electrical equipment lies at 50-80% load. Though, all efforts are being made to have Efficiency curve flatter between 25% to 100% load, Efficiency at lower than 40% load is disproportionately lesser compared to optimal performance.

Intelligent Energy optimizer functionality in UPS systems ensure UPS systems are dynamically switching ON/OFF as per load pattern and Maintaining load on each UPS above 50%. As this load range gives highest efficiency, the customers will reap in benefit from reduced energy bills, enhancing the profitability.

Energy saving measure 3: Use of energy efficient transformers

The transformer is at the heart of an electrical distribution system. The power to IT systems is distributed through transformers. The efficiency of the transformer plays a major role in efficient power distribution.

The latest models of transformers offer better efficiency levels than conventional transformers, which have comparatively high inherent losses associated with them Further, judiciously selecting optimal size of the transformer will ensure that transformer faces optimal load for which its efficiency is higher.

The inherent loss associated with transformers depends upon the type of core used in the transformers.

The magnetic core of these transformers is built with superior material which helps to conserve energy right from the time of installation.

Energy saving measure 4: Harmonic mitigation

Energy Efficiency through lowering of KVA intake can be effectively achieved through mitigation of harmonics by deploying a host of Parallel-connected harmonic filters. There are various kind of Harmonics filters available viz the Passive uncompensated filter, Passive compensated Filter and Active-Dynamic Active Filters out of which a combination of Passive and Active Filters are found to be most beneficial. Ideally Active filters, selected for a combination of loads rather than individual loads, are found to be techno-economically beneficial since harmonic currents of some individual loads cancel each other. The Type, rating and location of the Filters to be cautiously selected and sized optimally based on extent of correction needed. The Point at which correction is needed (Point of common Coupling as per per IEEE 519) and the efficiency of the Filter circuit. It may be advisable to prefer those means of Harmonic reduction which are associated with lowest possible increase in KW consumption and heat load and do not increase the number of components in series electrical path.

Nonlinear loads such as UPS, SMPS, and rectifiers, which are predominantly used in Datacenters, lead to harmonic distortion.

Excessive harmonic currents can overload wiring and transformers, leading to additional losses. Therefore, it is necessary to maintain the harmonics levels in the electrical system as recommended in the IEEE 519 standards.

The permissible limit for voltage harmonics varies with the voltage level of operation. Table 2.4 shows the permissible voltage harmonic limit in percentage for various distribution voltage levels.

Table 2.4: Voltage harmonic levels for various distribution voltage levels

Supply System Voltage (kV)	Total Harmonic Voltage Distortion VT (%)	Individual Harmonic Voltage Distortion (%)	
0.415	5	4	2
6.6 and 11	4	3	1.75
33 and 66	3	2	1
132	1.5	1	0.5

The permissible limit for current harmonics as per IEEE standards is specified in table 2.5.

Current distortion limits for general distribution systems end user limits (From 240 V to 69 kV)

Table 2.5: Allowable current harmonic distortion for various Isc/IL ratios

SCR= Isc/IL	$h < 11$	$11 < h < 17$	$17 < h < 23$	$23 < h < 35$	$35 < h$	TDD
<20	4.0	2.0	1.5	0.6	0.3	5.0
20 – 50	7.0	3.5	2.5	1.0	0.5	8.0
50 -100	10.0	4.5	4.0	1.5	0.7	12.0
100 - 1000	12.0	5.5	5.0	2.0	1.0	15.0
>1000	15.0	7.0	6.0	2.5	1.4	20.0

* Values shown are in percentages % of “average maximum load Current”.

* SCR = Short Circuit ratio (short circuit current at point of common coupling divided by customer average maximum load current)

* TDD = Total Demand Distortion (uses maximum load current as the base, rather than fundamental current)

Energy Saving Measure 5: Monitoring of critical components

Continuous monitoring of the key electrical parameters is important in maintaining the efficient performance of the electrical distribution system.

Parameters such as voltage, current, power factor, and total harmonic distortion have to be monitored on a regular basis. Whenever there is a deviation in the values of parameters, necessary action has to taken to bring them back to the desired levels.

Continuous monitoring facilitates:

- › Planning for an expansion of facilities
- › Managing Preventive Maintenance Program and taking proactive measures to avoid Interruption of critical operations
- › Providing early warning, thus allowing corrective actions to be taken to prevent interruptions
- › Providing event notification, diagnosing and resolving Problems
- › Analyzing negative events to prevent their recurrence
- › Reducing Mean Time to Repair (MTTR)
- › Exposing issues that should be addressed in the next design cycle



Figure 2.24: Monitoring Activities

Energy Saving Measure 6: Use of Energy Efficient power supplies

Voltage is stepped down in the incoming transformer and the conversion of power takes place in the UPS switching circuit.

Power conversions result in certain losses in the equipment. The latest PDUs and UPS system using low-loss switching devices minimize the loss in the system and improve system efficiency.

Energy Saving Measure 7: Regular Maintenance and Testing of Electrical Systems

'Maintenance' refers not only to the repair and maintenance of equipment, but also operating the equipment in a safe, reliable and efficient manner.

Maintenance personnel have to keep track of all the above aspects to ensure operational excellence in electrical systems.

An Energy Optimizer is a device which senses the load demand continuously and controls the operation of the number of UPSs at any point of time, and also maintains optimum loading on all UPS

Energy saving measure 8: Regular maintenance of capacitors in the UPS

DC capacitors used in the UPS system wear out after a certain number of working hours. If a worn out capacitor is allowed to operate in the UPS system, it would result in the inverter failing to operate under load and would cause an increase in the ripple current in the batteries.

This results in inefficient operation of the equipment. Therefore, it is necessary to monitor the capacitors at regular intervals to ensure that they are in proper working condition.

Energy saving measure 9: Energy efficient motors

Energy Efficient Motors have design improvements incorporated specifically to increase their operating efficiency over standard motors. Energy Efficient Motors are designed with low operating losses.

The efficiency of Energy Efficient motors available in the market ranges from 80 to 95%. Therefore opting for energy efficient motors at the design stage will lead to improved energy efficiency.

Energy Saving Measure 10 : Energy Efficient Cabling / Busbars

Selecting Cables / Bus-bars with proven lesser impedance-drops per metre of its length helps a lot in reducing transmission losses and contributes appreciably in Energy Efficient System. Further, in occasions it may be a good idea to select Cables “One-Size-Up” which means just by going for higher sized cable one may ensure lesser drop and therefore, higher distribution efficiency.

Case Study 1

POWER QUALITY IMPROVEMENT IN A DATACENTER BY INSTALLING HARMONIC FILTERS

Background

The Power factor is one of the major parameters that influence the performance of an electrical system. The power factor is influenced by both the reactive power requirement of the load and the harmonics present in the system.

Harmonics are generated due to the presence of non-linear switching loads such as UPS, display units, PAC, and HVAC controls in the circuit. Harmonics, when exceeding a certain limit in a system cause undesirable effects. The undesirable effects caused by the presence of harmonics are malfunctioning of protective relay equipments, de-rating of equipment capacity, premature failure due to increased stress on the electrical system, etc.

The presence of higher harmonics affects the power factor negatively and increases the KVA demand requirement for any KW load

IEEE 519 standards specify the limit for both voltage and current harmonics. The current harmonics limit depends on the ratio of Short Circuit Current (SCC) at PCC to average Load Current of maximum demand over 1 year. Thus the current harmonic limit is a function of system design.

Also the voltage harmonics depends on the bus voltage. Typically, the voltage harmonic limit at 415V bus is 5%.

Project details

The company is an Indian telecom giant with an exclusive Datacenter catering to their internal needs. The organization conducted an energy study to look into opportunity-related cost reduction through better energy management.

The energy cost has two components, one based on the actual power consumption (kWh or Active power) and the other based on the maximum demand registered (kVA or apparent power). The latter is affected by the system power factor.

The measured system power factor was 0.88 lagging for the average load of 1030 kW. The harmonic levels in the system were also measured with a power quality analyzer and the measurements were analyzed.

The project team inferred that the power factor was low and can be substantially improved. They also inferred that harmonic levels in the system can be reduced. It was decided that solutions for improving the power factor and mitigating the harmonics can be implemented by using a combination of APFC (Automatic Power Factor Correction) system and an Active harmonics filter.

The organization procured and installed a 2 x 225 Amp Active Harmonic Filter along with a 225 kVAR APFC system in the Main Incoming panel of the building housing the Datacenter.

This improved the power factor from 0.88 lagging upto 0.97 lagging, reducing the demand by 96 kVA.

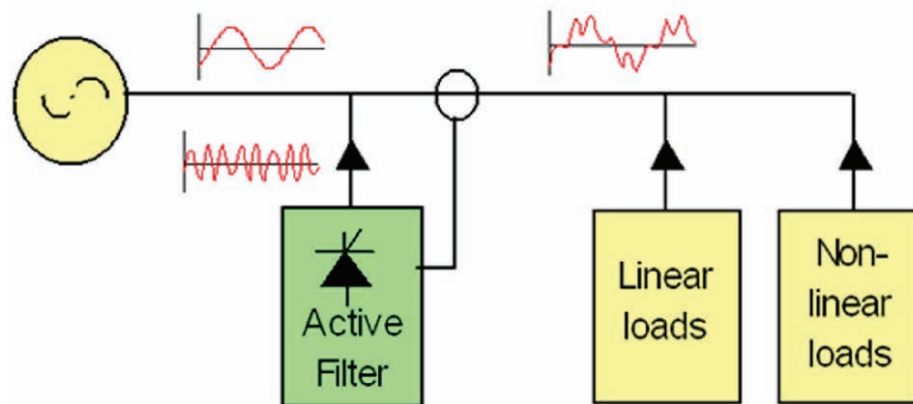

Figure 2.25: Typical Connection of an Active Harmonic Filter

The harmonic filter design is site specific, and is based on the operating conditions. The filter has to be selected based on the requirements specified in the detailed study

Benefits of the project

In spite of the server Load remaining the same (600 KW), there was a small increase in power consumption to compensate for the losses in filters (19kW). There was a 96 KVA reduction in Demand, with the demand reducing from 1198 KVA to 1102 KVA. The summary of the pre- and post- filter installation audit is given in table 2.6.

Table 2.6: Data Summary of the Facility Audit: Pre- and Post-Filters Installation

	KW	KVA	PF
Total with APFC capacitor banks Connected	1050	1198	0.88
After installing Active Filter	1069	1102	0.97

Benefits of the project

- Reduction in demand from 1198 kVA to 1102 kVA
- Harmonics level controlled to be within desirable limits
- Better operating power factor
- Reduced electricity bill

Financial analysis

The implementation of active harmonics filters resulted in an annual savings achieved of Rs 3.3 million. The investment made for this project was Rs 4 million. The pay back period is 15 months.

Cost benefit analysis

- Annual savings - Rs. 3.3 million
- Investment - Rs. 4 million
- Payback period - 15 months

- The project involving installation of Harmonic filters is recommended for scenarios where harmonic levels are higher than the IEEE 519 standard
- The project involved minor modification/retrofitting of filters in electrical infrastructure requiring external expertise. The project, being capital intensive, has to be taken up as part of a business decision

Case Study 2

ENERGY EFFICIENCY IMPROVEMENT IN UPS SYSTEMS BY LOADING OPTIMIZATION

Background

A Datacenter is an environment in which uptime and availability is critical and needs to be maintained at the maximum. The uptime of a Datacenter can be maintained by ensuring the availability of a continuous power supply to its IT equipment.

Reliability in power supply is achieved through an Uninterruptible power supply (UPS) system. The UPS is one of the major energy consumers in a Datacenter, as it is used to provide continuous power supply to all IT equipments. Thus the continuous functioning of a UPS system is critical in a Datacenter.

The efficiency of the UPS system varies with loading. Typically, an UPS system has maximum efficiency at 75-80% loading. At loading of less than 40-45%, the efficiency reduces drastically. Table 2.7 shows the typical efficiency of the UPS system corresponding to loading of the UPS system. Figure 2.26 shows the Loading vs Efficiency curve of an UPS system.

Table 2.7: EFFICIENCY DATA OF 200 KVA UPS SYSTEM

% Loading	Efficiency
10%	80.00%
15%	84.00%
20%	87.00%
25%	89.16%
30%	91.00%
40%	91.95%
50%	92.80%
60%	93.00%
70%	93.40%
80%	93.46%
90%	93.15%
100%	93.00%

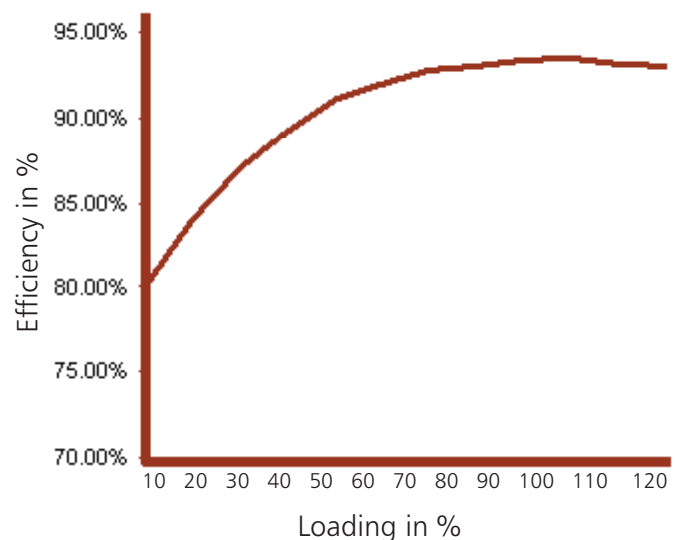

Figure 2.26: Loading (vs.) Efficiency curve of the UPS

Project details

The organization is a well known software development company with international clientele. The organization maintains a Datacenter which caters to the needs of various clients abroad.

The company initiated various programmes for energy management and also conducted Power Quality and Energy audit.

During the assessment of the UPS, the loading on the UPS system was found to be changing constantly. The change in loading pattern was due to,

- › Flexible operating hours of developers resulting in randomness of load
- › A number of software development projects being worked upon

For a maximum load of 200 kVA, four modules of 200 kVA UPS were installed in a 4 x 200 kVA configuration as shown in figure 2.27. Thus, even if the load equals 200 kVA, each UPS would be loaded to a maximum of 25% only.

In reality, the load was never 200 kVA but lower, varying from a minimum of 100 kVA to a maximum of 144 kVA at different times of a day, thus imposing loads of differing percentages on the UPS systems. The loading pattern observed for the period of two days is shown in figure 2.28.

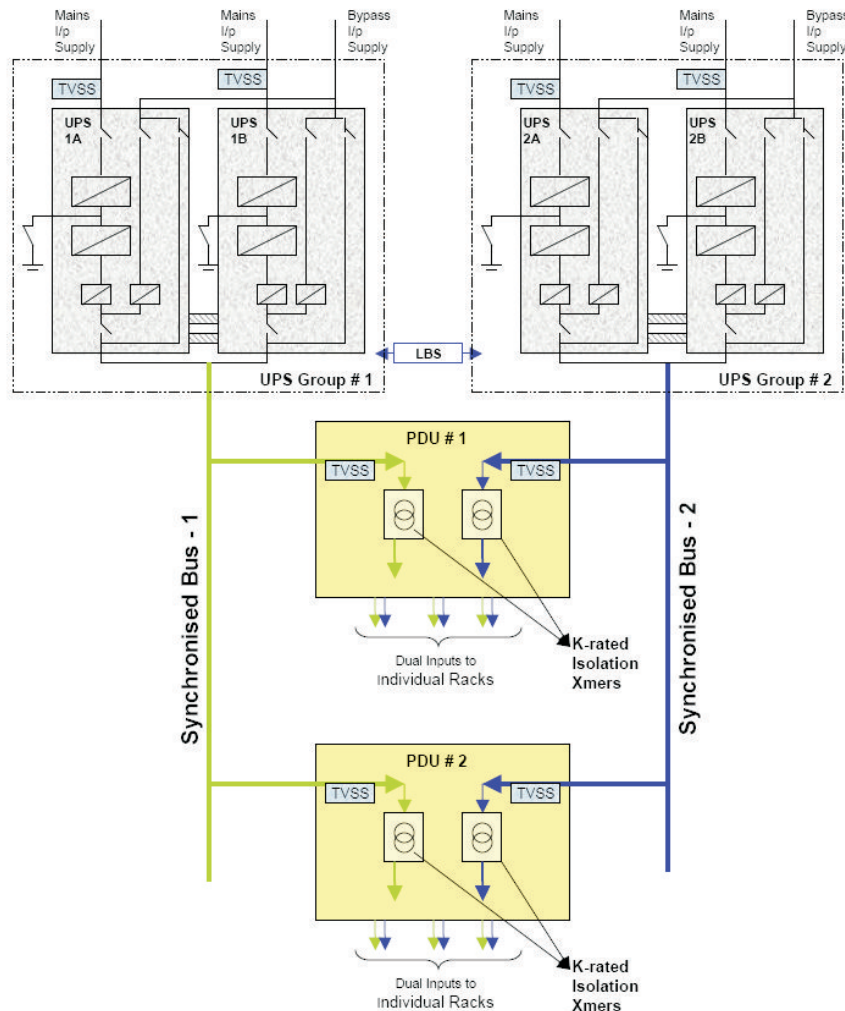

Figure 2.27: Schematic diagram of UPS configuration

Load variation pattern observed : From 16/07/08 (08:13 pm) to 18/07/08 (10:08am)

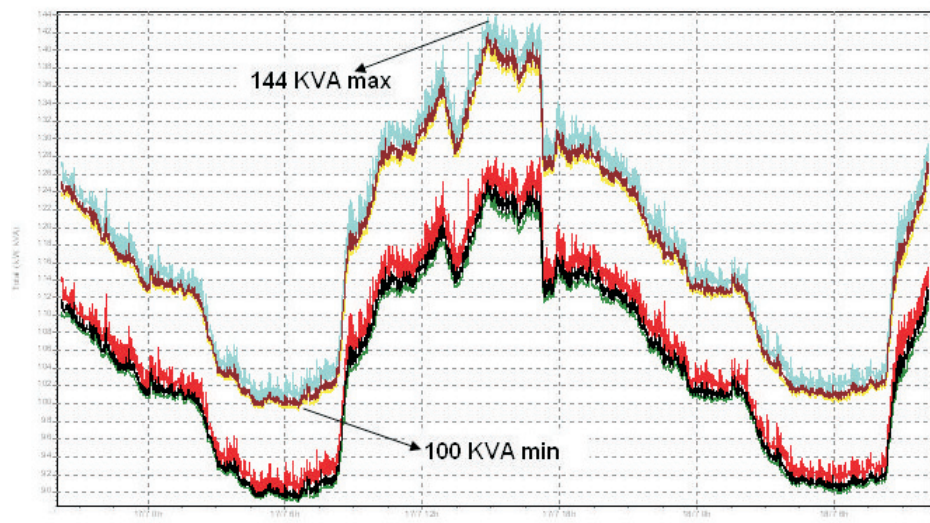

Figure 2.28: Loading pattern on UPS

The total load on the system varied from 100 kVA to 144 kVA which imposes 12.5% to 18% loading on individual UPS. The project team observed that efficiency of UPS at these loading is around 83%, from the efficiency chart supplied by the manufacturer.

There was potential for improving the loading on the UPS system. An automation system was installed to monitor the loading on individual UPSs, and to give commands on the basis of operation to all UPS. The desired loading on UPS was maintained by designating the other UPSs to standby mode and bringing them online whenever the load increased.

In the event of increase in load or malfunction in the On-load UPS, the other UPSs in the loop would automatically take up the load. This mechanism increased the loading of the UPS system and thereby increased circuit efficiency.

Care was taken to ensure that the circuit would be failsafe and very reliable in its design. Since the circuit consisted of sensors and control logics only, its own losses were negligible.

Benefits of the project

For the same load variations, reliable operation of the UPS system was maintained. Intelligent control logic regulated the operation of the inverter in the load bus of the UPS thus increasing the loading on the UPS system.

The efficiency of the UPS system was improved by 6.7%. This resulted in a reduction of 20 kVA in demand consumption.

The improvement in efficiency due to load optimization is represented in Table 2.8 and Table 2.9.

Table 2.8: Summary Data Record & Analysis Pre-implementation of project

Before Planned Action				
	Load (kVA)	UPS capacity (kVA)	Loading on UPS (%)	UPS Efficiency (%)
Loading Status - 1	127	800	15.88%	84.6%
Loading Status - 2	114	800	14.25%	83.3%
Loading Status - 3	100	800	12.50%	82.3%
Loading Status - 4	130	800	16.25%	85.1%
Loading Status - 5	144	800	18.00%	86.4%

Table 2.9: Summary Data Record & Analysis Post-implementation of project

After Planned Action				
	Load (kVA)	Total UPS capacity	% loading	UPS Efficiency
Loading Status - 1	127	400	31.75%	90.8%
Loading Status - 2	114	400	28.50%	90.3%
Loading Status - 3	100	400	25.00%	89.2%
Loading Status - 4	130	400	32.50%	91.1%
Loading Status - 5	144	400	36.00%	91.4%

- The project on loading optimization of UPS systems would find replication in scenarios when the loading of individual UPS in a bank of UPS systems is low
- The project involves minor modification/retrofitting of power distribution infrastructure requiring external expertise. The project, being capital intensive, has to be taken up as part of a business decision

Case Study 3

ENERGY EFFICIENCY IMPROVEMENT IN LIGHTING SYSTEM BY REPLACING FLUORESCENT LAMPS WITH LIGHT EMITTING DIODE (LED) LAMPS

The project demonstrates the benefits of using Light Emitting Diode (LED) lamps instead of conventional Compact Fluorescent Lamps (CFL) in achieving savings in electrical energy consumption.

Background

A light-emitting diode is an electronic light source. LEDs present many advantages over traditional light sources such as lower energy consumption, longer life, improved robustness, smaller size and faster switching. However, they are relatively expensive and require more precise current and heat management as compared to traditional light sources.

One of the key advantages of LED-based lighting is its high efficacy, as measured by its light output per unit power input (Lumens/watt).

LEDs are available in different performance classes such as standard; mid and high power packages, in various brightness levels and package sizes and in a range of colors including all shades of white, RGB, and colors-on-demand.

The comparison between LED and Fluorescent lamps are given in Table 2.10.

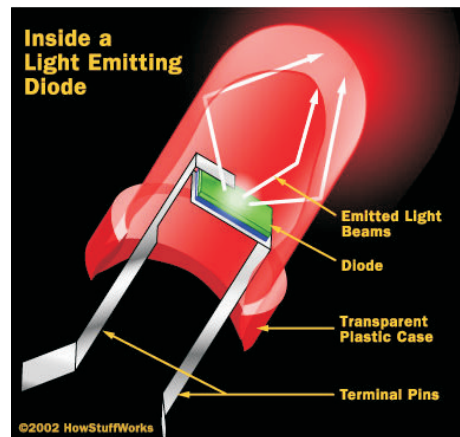

Figure 2.29: LED lamp

Table 2.10 : Comparison of LED and Fluorescent lamps

Parameter	Fluorescent Lamps	LED Lamps
Efficacy	60-65 lm/W	105-120 lm/W
Lifetime	10000 to 15000 hrs	35000 to 50000 hrs
Mechanical strength	Fragile	Robust
Environmental aspect	Contains mercury	Less mercury content
Initial cost	Medium	High
Total ownership cost	High	Low
Voltage sensitivity	Medium	High
Temperature sensitivity	Medium	High

Project details

The company carried out a lighting study throughout the facility. The lighting energy and LUX levels were recorded and analyzed. It was noticed that a considerable share in overall operating cost could be attributed to lighting.

The project was feasible and had an attractive pay back period due to high energy costs

The company decided to replace all compact fluorescent lamps with latest energy efficient LED lamps.

Retrofitting of lamps was possible due to the fact that no extra or special wiring is required for LED lamps. The LED lamps were installed in utility rooms, and laboratories. They also replaced the existing emergency lights in the Datacenter.

Also, the company segregated the lighting systems, based on the illumination requirement and occupancy time. Lighting controls such as movement sensors were adopted for areas with intermittent occupancy.

Benefits of the project

- Reduction in lighting power consumption by 73%, reducing total ownership cost (TOC)
- No mercury content in LED lighting, thus addressing environmental concerns and disposal issues
- Increase in lifetime upto 3 times

Benefits of the project

Conventional CFLs were replaced with Energy efficient LED Lamps. The implementation was financially rewarding for the organization. The project also had a positive environmental impact as LED lamps contain no mercury.

The annual savings achieved was Rs 0.54 million. The investment made for this project was Rs 1 million which is paid back in 22 months.

Cost benefits analysis

- Annual savings - Rs 0.54 million
- Investment - Rs. 1 million
- Pay Back - 22 months

The project involves minor modification/retrofitting in lighting infrastructure requiring external expertise. The project, being capital intensive, has to be taken up as part of a business decision

Chapter 3

Datacenter Cooling

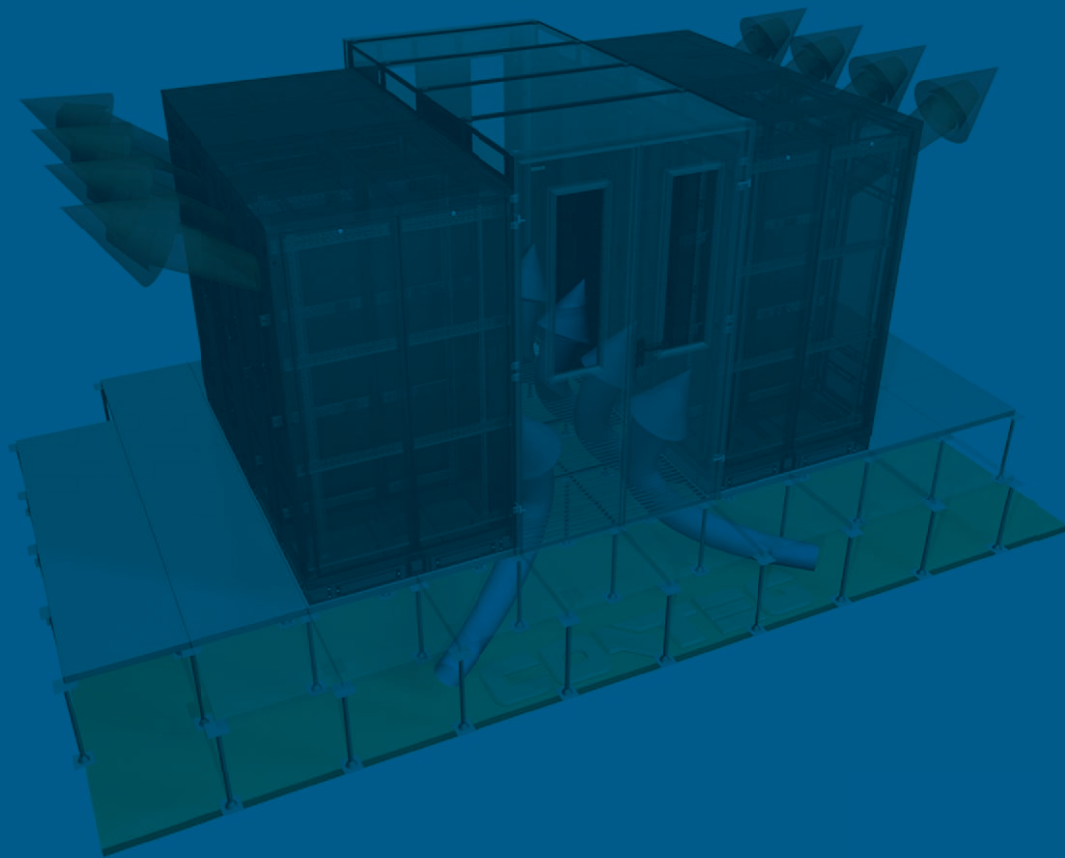

SUMMARY NOTE ON 'DATA CENTRE COOLING SYSTEM'

Whereas the physical world is shrinking in terms of connectivity, however, the virtual world is expanding its presence into our lives. With growing dependence of human society on the Information Technology and miniaturization of electronics, increasing amount of information is getting packed into the Data Centres in the same floor space. These Data centre are today regarded as power guzzlers and with emergence of India as hotbed for IT industry, the size, complexity as well as power requirement of Data Centre's too has grown exponentially. Since higher power demand results in increased internal heat rejection, thus its removal is a key requirement. The operating temperatures and relative humidity levels within Data Centre also needs to be closely controlled to ensure reliability in performance. In a typical Indian Data Centre, HVAC systems consume nearly 35-40% of the total power demand, which presents an opportunity for significant energy savings.

Lack of infrastructure and power scarcity has propelled Indian Owners to innovate on energy conservation methods that are unique to our country. Add to it the wide ranges of ambient conditions within the country and exposure to International practices that combined present a huge potential to save on operation cost. The intent of this exercise is to present to readers a compilation of all possible strategies as a handy tool which can be explored during construction stage.

This exercise of developing Guidelines & Best Practice for Energy Efficiency in Indian Data Centre by CII under the guidance of BEE is a unique initiative which brought all the players like Planners, Consultants, Users, Suppliers and Manufacturers on a common platform to share their ideas.

The chapter on 'Data Centre Cooling System' has come out with a set of few focused stress points like use of economizer, intelligent controllers, EC fans, Aisle containment, redefining of the operating specifications etc and should be a good reference material.

I am thankful to all members of this core Group for their contribution towards the successful completion of section on Air-conditioning and express my sincere thanks to Dr Ajay Mathur, Mr Sanjay Seth & Mr S Raghupathy for their guidance and Suprotim Ganguly for technical contribution through out this project. Ashish Rakheja



Ashish Rakheja

Chairman, Core Group on 'Cooling System' &
Chief Operating Officer, Spectral Services Consultants Pvt.Ltd.

LIST OF MEMBERS ON COOLING SYSTEM (CORE GROUP-2)

SI.NO	Name	Organization
1	Mr Ashish Raheja	Spectral Services Consultants Pvt Ltd.
2	Mr Anil Dev	Clivet TF Airsystems (P) Ltd
3	Mr Dhiman Ghosh	Emerson Network Power (India) pvt Ltd
4	Mr Debashish Chakraborty	APC-MGE
5	Mr. S. Gagneja	Uniflair india pvt ltd
6	Mr Kiran Desai	Wipro Technologies
7	Mr Kiran kumar	Ctrl S Datacenters Ltd.
8	Mr Madhav Kamath	USAID ECO-III Project, IRG
9	Mr Muralidharan Iyengar	Blue star Ltd.
10	Mr Sanjeev Gupta	IBM India Pvt. Ltd.
11	Mr Saurabh Agarwal	Cadence Design Systems (I) Pvt Ltd.
12	Mr Salender Tomer	Hewlett Packard India Sales Pvt. Ltd.
13	Mr Sital Bachhav	STULZ-CHSPL (INDIA) PVT.LTD
14	Mr Sreekumar Kollara	SCHNABEL dc consultants India
15	Mr Sushanta Ghosh	Emerson Network Power (India) pvt Ltd
16	Mr Sudeep Palanna	Texas Instruments (India) pvt Ltd
17	Mr Vijay Venugopal	Cisco Systems (India) Pvt. Ltd.

3.1 Introduction

The market keeps evaluating latest technologies such as Virtualization & Consolidation of Datacenter so that the IT Infrastructure can be used with higher capacity utilization with better ROI. The development of high density equipment for performance improvement has resulted in concentrated generation of heat, posing a challenge to Data Center cooling systems.

Effective heat removal from IT equipment is one of the most essential processes in the optimum operation of Datacenter

The continuous operation of IT equipment and power delivery systems generate a significant amount of heat that must be removed from the Datacenter for the equipment to operate properly.

In a typical Datacenter, cooling system consumes 35 - 40% of the total power consumption, which also presents an opportunity for significant energy saving.

The operating temperature and humidity level in a Datacenter has to be maintained at recommended levels to ensure the performance of all the IT equipment. Therefore reliable functioning of the cooling system is extremely important.

3.2 Cooling process in a Datacenter

The cooling process in a Datacenter is a closed loop system, ie, the cold air supplied from the CRAC flows through the IT equipment and the hot air is re-circulated to the CRAC unit for removal of heat.

Each server rack draws in cold air through the front of the rack and which gets heated as it circulates inside the servers and exits the rack from the rear side. Cold air is supplied to the server rack by the following two ways.

- Conventional method - Room cooling technique
- Contemporary method - Hot aisle/Cold aisle containment technique

In the conventional room cooling technique, the temperature distribution in the room is determined by the inlet and outlet temperatures of different racks. The inlet temperature of a rack depends on the cold air supplied from the CRAC. The outlet temperature of a rack therefore depends on the inlet air temperature and the power consumption of that rack.

The mixing of cold and hot air results in an increased distribution supply temperature and reduced return temperature to the crac which results in increase of load on the CRAC units.

Now a days, several Data Centers are coming up with Hot aisle / Cold aisle containment technique.

Figure-3.1 shows the typical layout this technique. The racks are arranged such that the hot and cold sides are segregated to form an array of alternative Cold and Hot aisles.

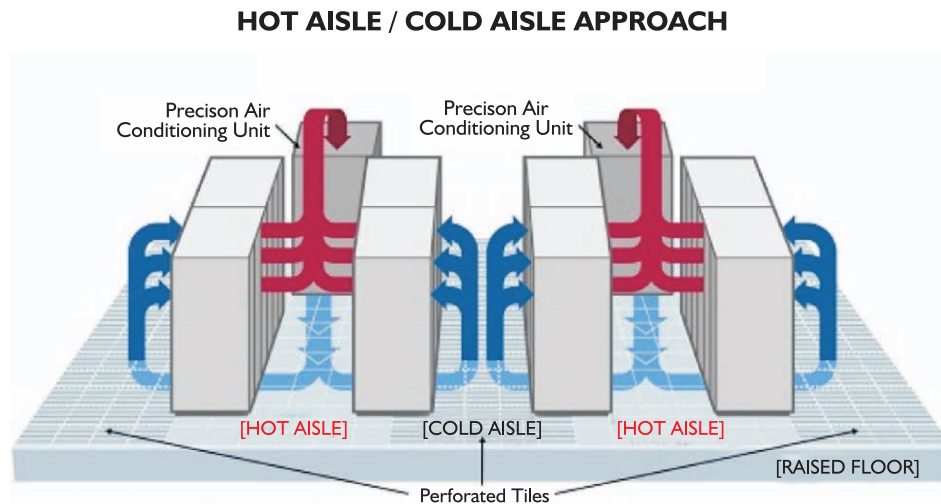

Figure 3.1: The raised floor of a Datacenter with the Hot aisle /Cold aisle setup

Air is being supplied through perforated floor tiles in the cold aisle. The inlets of each rack face the cold aisle and draws cold air coming out of the perforated floor tiles. This arrangement allows the hot air exiting from the rear side of the racks to return to the CRAC, thus minimizing the recirculation of hot exhaust air from the rack back towards the inlets of other racks. Hence, it becomes very important to ensure that significant amount of Cold Air (Equivalent or more than the amount required by rack load) should be available in the front of the racks. As higher perforation levels of the rack door (up to 83%) enable better airflow, it is recommended to have as high perforation levels as possible. Designs of racks are available upto 83% perforation levels.

Servers with critical duties will shutdown or fail when the inlet temperature and humidity levels rise above the specified standards, which typically are 20-25°C and 40-55%RH. The temperature of high density equipment in Datacenters can rise up to 40°C in 3 minutes in the absence of CRAC units. Therefore, failure-free operation of CRAC units is absolutely necessary to ensure reliable operation of the servers.

The cooling system has various components such as

- › Chiller units
- › Chilled water pumping system
- › Precision air conditioner unit
- › Air distribution system.

Both the chilled water system and direct expansion type of cooling are used in Datacenters.

3.3 Critical cooling configuration and its components

Precision Air Conditioner (PAC) units are essential in a Datacenter to maintain the equipment within the manufacturers' specified temperature/humidity range. PAC is a high precision environment control system, specially designed to manage the cooling, heating & ventilation requirements of mission critical applications. The precision air conditioner units could have one of the configurations, which are detailed below:

3.3.1 Direct expansion air cooled unit

Direct expansion (DX) system is a compressor based refrigeration system equipped with refrigerant as a cooling medium. The outdoor condenser unit used for heat rejection can be air/water cooled. The indoor and outdoor units are connected by means of pipes. The general schematic of the configuration is as shown below:

CRAC's are one of the most common cooling systems installed in upcoming Datacenters. CRAC uses the direct expansion of refrigerant gases to remove heat inside the Datacenter and reject it to outdoor spaces. These systems typically has a relatively small (30 Tons sensible capacity) compressor system and a evaporator coil installed in the datacenter space, and a condensing unit installed outdoors to reject the energy from the room.

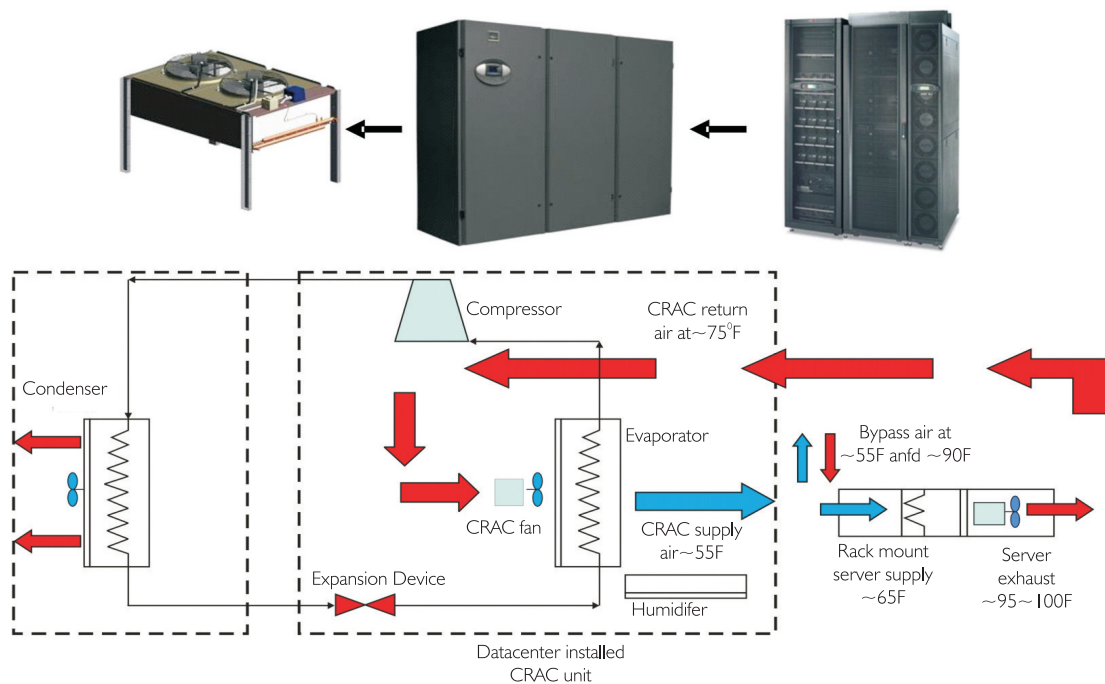

Figure 3.2: Typical Layout for direct expansion based precision cooling

A typical layout for precision cooling with direct expansion of refrigerant in evaporator is shown in figure 3.2. Due to the low temperature of the evaporator coil, the moisture in the air condenses and dehumidifies the air. A humidification system is provided to impart required moisture to the air to maintain the humidity level within the specified range.

3.3.2 Chilled water units

Chilled water units are refrigerant less cooling units which uses chilled water as a cooling medium. An externally located chiller system supplies chilled water to the unit as per the cooling requirement of the Datacenter. The typical layout of the chilled water system is as shown in figure 3.3.

The chilled water-based CRAH units are the most commonly adopted system for Data Centers requiring large capacity cooling (i.e. 100-1000 tons). The higher capacity also facilitates efficient energy usage in the compressor and fans.

3.3.3 Dual fluid units

The dual fluid unit is a combination of direct expansion and chilled water unit. The chilled water units are connected to the external chiller system for the regular supply of chilled water. Such a combination unit gives advantage of power saving and redundancy.

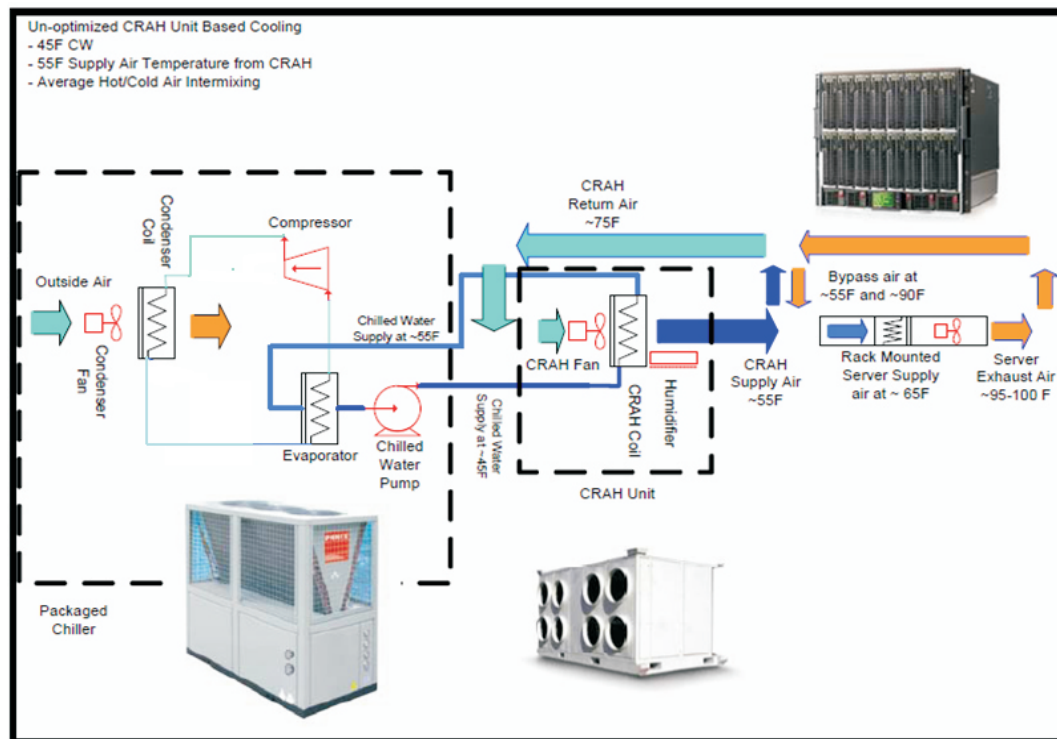

Figure 3.3: Typical layout for chilled water based precision cooling

3.3.4 Open architecture

The cooling coils are deployed near the heat load either, inside or outside the server rack and utilizes the room air volume as a thermal storage ride through short power outages

3.3.5 Closed architecture

The cooling coils are deployed inside a fully enclosed rack

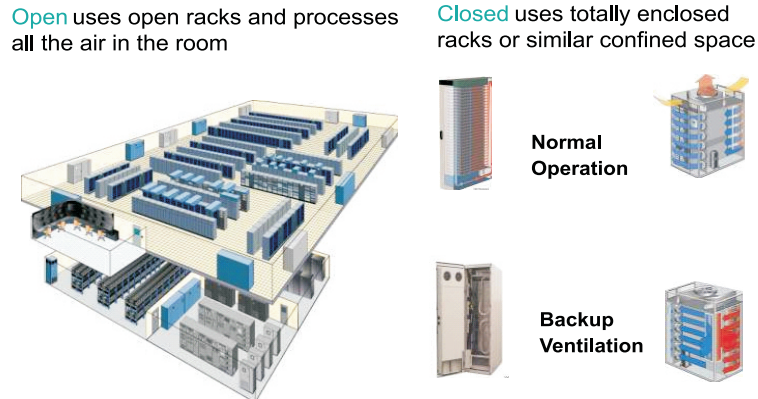

Figure 3.4: Open and closed Architecture

Table 3.1: Advantages & disadvantages for different configuration:

<p><i>Open vs. Closed Cooling Architecture System Comparison</i></p>	<p>Open Architecture System</p> <p>Advantages</p> <ul style="list-style-type: none"> ❑ Ride-through/redundancy on room level ❑ Lower first cost and lower operating cost ❑ No limits on rack selection ❑ Self regulating capacity <p>Disadvantages</p> <ul style="list-style-type: none"> ❑ Higher audible noise ❑ Mainly a room solution 	<p>Closed Architecture System</p> <p>Advantages</p> <ul style="list-style-type: none"> ❑ Low audible noise ❑ Deployable as a single rack <p>Disadvantages</p> <ul style="list-style-type: none"> ❑ Shorter ride-through time on cooling system loss ❑ Higher first cost ❑ Fixed capacity
	<p><i>Pumped Refrigerant Based vs. Water-Based System Comparison</i></p> <p>Pumped Refrigerant Based System</p> <p>Advantages</p> <ul style="list-style-type: none"> ❑ No water in data center - No risk if a leak occurs ❑ Higher energy efficiency ❑ Smaller piping requirements <p>Disadvantages</p> <ul style="list-style-type: none"> ❑ Possible compatibility issues with small rooms ❑ Higher fluid cost ❑ Piping must be overhead 	<p>Water-Based System</p> <p>Advantages</p> <ul style="list-style-type: none"> ❑ Lower fluid cost ❑ No limitation to room size <p>Disadvantages</p> <ul style="list-style-type: none"> ❑ Water damage risk if a leak occurs ❑ May require fluid treatment to prevent fouling ❑ Limited overhead cooling options

3.4 Precision Air Conditioner (PAC)

The following are some of the key features of PAC over comfort cooling systems.

Some of the key differences between Precision Air and Comfort Air conditioning are highlighted in table 3.2.

Table 3.2: Key differences between Precision Air and Comfort Air conditioning

Parameters	Precision	Comfort
Sensible Heat Ratio	0.90 - 0.95	0.70
Temperature Control	$\pm 1^{\circ}\text{c}$	$\pm 3^{\circ}\text{c}$
Humidity Control	$\pm 5\%$ RH	No control
Operating Hours	8760/annum	2000/annum
Air Movement	500 - 650 cfm/TR	300 - 450 cfm/TR
Filtration Efficiency	95%	65%
Built - in redundancy	Available	Not Available

3.4.1 Sensible Heat Ratio (SHR)

There is a need to ensure the control of conditioned environment due to high levels of heat generation by the equipment. The heat load on the system can be categorised into sensible heat and latent heat.

Sensible heat removal or addition causes subsequent changes in dry bulb temperature. Latent heat load pertains to the amount of moisture content in the air. The total cooling capacity of a PAC is the summation of both sensible and latent heat.

Total Cooling Capacity = Sensible Cooling + Latent Cooling

The ratio of the sensible cooling capacity to total cooling capacity is turned as Sensible Heat Ratio (SHR).

Electronic devices generates more sensible heat rather than latent heat. The Precision Air Conditioner provides about 0.9SHR, which suits the cooling requirement of the electronic devices. The comfort-cooling machine provides about 0.65 to 0.7SHR, which is suitable for human comfort as shown in Figure 3.4a.

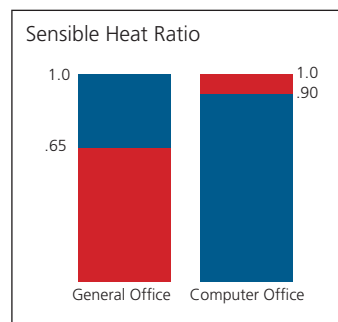

$$\text{Sensible Heat Ratio (SHR)} = \frac{\text{Total cooling}}{\text{Sensible cooling}}$$

Figure 3.4a : Sensible Heat Ratio

A Precision Air Conditioner is designed for higher sensible heat ratio which suits the cooling requirement of electronic devices

3.4.2 Precise Temperature and Humidity

A key advantage benefit of the PAC is its ability to control temperature precisely. The control is provided by the microprocessor which response quickly to variations and maintains less tolerances which is a requisite for a stable environment. Precision Air Conditioners typically include several stages of cooling or heating and humidification or dehumidification cycles which allows it to satisfy all ranges of temperature and humidity requirements.

3.4.3 Protection against airborne contaminants (Air Quality)

With most critical equipment housed either in remote locations or in dedicated server rooms, there is an increasing need to ensure superior air quality while also ensuring less downtime.

Precision Air Conditioners operate at a high air-flow rate per unit of heat removed. Generally, 160 CFM (76 lps) per kW or greater

Further, the precision cooling equipment allows air to flow through filters ensuring a cleaner environment. Precision Air Conditioners typically use deep-pleated filter bank having moderate to high efficiency to minimize airborne particles. The precision air conditioning equipment is capable of providing air filtration efficiency of 95% upto 5-micron sizes.

3.5 Criteria for cooling system design

The following are some of the basic criteria for designing the cooling solution for Datacenter. These criteria have been developed based on the discussions with the experts, consultants, equipment suppliers and users of datacenter. These can be used as a guideline while designing new datacenters.

3.5.1 Load density

The high concentration of equipment can result in significant increase of load density in an IT room/ Datacenter as compared to a typical office. Therefore, it is vital to build a system that can keep a steady check on the load density. load. Load density is a crucial parameter to be monitor, which has effect on sensible cooling requirement and air distribution pattern.

The typical Load Density values are as under;

Office	-	5 – 15 watts / sq. ft. (54 – 161 watts / sq. m)
IT Room/Datacenter	-	50 – 200 watts / sq. ft. (538 – 2,153 watts / sq. m)

3.5.2 Temperature and Humidity

The temperature and relative humidity are extremely important because it impacts the reliability and optimum operation of all equipment in a datacenter. The typical design conditions recommended are 72-75°F (22-24°C) and 45-50% R.H.

3.5.3 Air quantity

The high CFM / kW (Lps / kW) inherent to precision systems contribute to the high sensible heat ratio, improved air distribution, and increased filtration rates.

Since the Datacenter load is highly varying in nature, the quantity of cold air supplied should also be varied based on the cooling requirement. A typical design air quantity should be 500-650 cfm/TR.

3.5.4 Air cleanliness

Since, airborne dust can damage equipment, therefore filters are extremely important for dust free operation of the datacenter. Filters should be deep pleated and operated with low face velocities which would increase its effectiveness. The filter efficiency should be 95% upto 5 μ particle size.

3.5.5 Vapor barrier

As almost all construction materials are transparent to moisture, a well-designed technology room must include a vapor barrier. Without a vapor barrier, the technology room will lose humidity in winter and will gain it in summer. This makes humidity set point control very difficult and increases the run times of compressors and humidifiers. Improving the vapor barrier helps in minimizing the energy waste.

To create an effective vapor barrier, ceilings should be sealed with material such as a polyethylene film, concrete walls should be painted with a rubber or plastic base paint, doors should seal tightly, and all pipes and cable penetrations should be sealed.

3.5.6 Redundancy

Redundancy is achieved by providing additional or standby unit that provides the required cooling capacity even after shutdown/ failure of one or more units. The cost of redundancy should be considered against the projected cost of downtime in technology room.

However, the difference between redundancy and over-design should be addressed to avoid in efficient operation of systems. A run-time-based operation of equipment and automatic control of operation are required for optimum operation of standby equipment.

3.5.7 Access control for parameter setting

The security of the air conditioners is as important as that of the hardware equipments in the technology room. The indoor units must be located within the technology room and should be placed within the same restricted access as the IT hardware. The outside heat rejection equipment should be placed on a roof or some other secure area within the facility in order

to keep the inner area secure. The access should be restricted other than the manager of Data Center. The access to set the operating values of key parameters should be password protected. Otherwise, it may lead to malfunction / inefficient operation of the system.

The cooling unit must be password protected so that no one can change the performance settings, which can lead to malfunction, & downtime.

3.6 The process of cooling in a Datacenter

The process of cooling used has a major impact on the energy efficiency of the datacenter. Two types of configurations namely conventional room cooling system and Hot aisle / Cold aisle approach are used in datacenters. The Hot aisle/Cold aisle configuration is the latest system and is more energy efficient in compared to the conventional room cooling system.

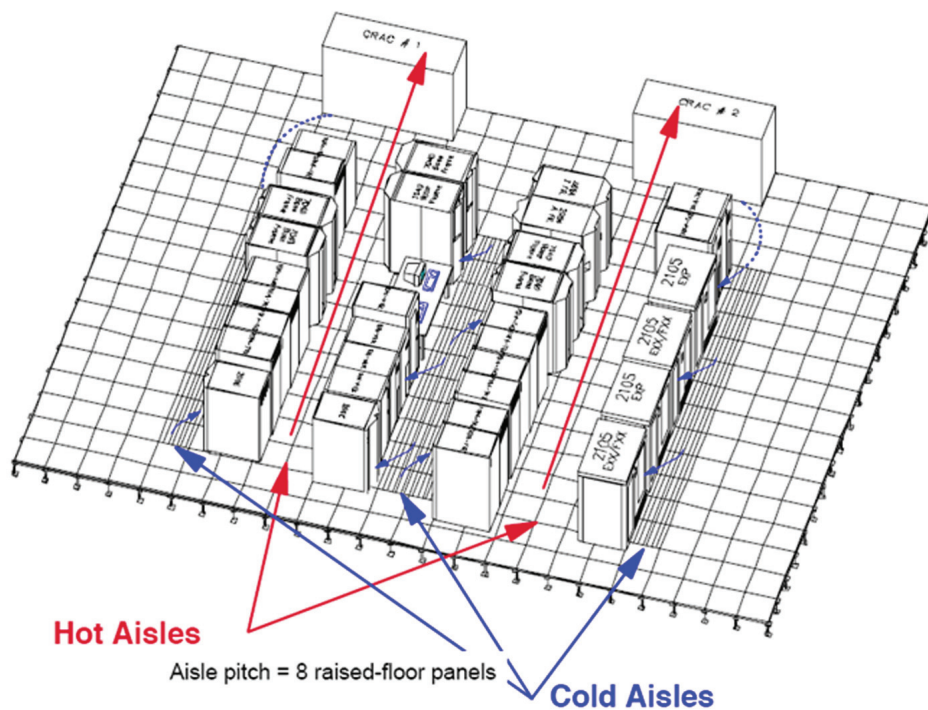

Figure 3.5: A typical layout of hot aisle and cold aisle approach

In the figure above, the racks are arranged such that the hot side and cold side of racks face each other to form alternative cold and hot aisles.

The cold aisle consists of perforated floor tiles separating two rows of racks. The chilled air from the perforated floor tiles is supplied to front of the racks. The inlets of each rack face the cold aisle. This arrangement ensures that the hot air exhausted from the rear of the racks is returned only to the PAC. Hence, it becomes very important to make available ample amount of cold air to the racks. Higher perforation levels (Ideally up to 83%) on the rack door enable better airflow.

3.7 Determining heat output of a system

The total heat output is the summation of the heat dissipated by individual components of datacenter. The components include IT equipment, UPS, Power Distribution devices, Precision Air Conditioning Units, Lighting, and operating personnel.

The heat output of UPS and Power Distribution systems consists of a fixed loss and a loss proportional to operating power. These losses are sufficiently consistent across various brands and models and so they can be approximated without significant error. The load due to Lighting and human load can also be readily estimated using standard values.

A detailed thermal analysis using thermal output data for every item in the Datacenter is possible, but a quick estimate using simple technique gives results that are within the typical margin of error compared to a complicated detailed analysis. The quick estimate can be performed by anyone with specialized knowledge.

3.8 Cable management

The increase in server population impose challenge for better cable management in Datacenter. If not properly managed, cables can obstruct airflow through perforated floor tiles. Inspect the under-floor plenum to determine if cabling or piping is obstructing the airflow. Overhead cabling is becoming increasingly popular, which eliminates the chances for obstruction of airflow. Deeper racks are now available to allow for increased airflow. Existing racks can be equipped with expansion channels to add depth for cables as well as airflow.

3.9 Measures for Energy conservation in Air-Conditioning system

Some of the energy saving opportunities available in the datacenter cooling system are detailed below.

3.9.1 The chiller system

Energy saving measure 1:

Increase the Chilled Water Supply Temperature (CHWST) Set point

The chilled water supply temperature (CHWST) set point is specified during the designing of a cooling system. The chilled water supply temperature has a direct impact on the operating efficiency of the chiller. As a rule of thumb, chiller efficiency improves by 1% for every 1°F increase in the evaporator-leaving water temperature, all other factors held constant.

Chiller efficiency improves by 1% for every 1°F raise in the temperature of water leaving the evaporator with all other factors held constant

A lower chilled water supply temperature causes de-humidification through condensation of moisture in the air at the cooling coil.

In general, chilled water supply temperature set point for facilities with normal humidity control requirements is maintained at 45°F. This set point value is common even in facilities that have relaxed or even no humidity requirements, due to the persistence of design “Rules of thumb”.

The chilled water supply temperature setpoint is increased maintaining the chilled water return temperature the same so that the chilled water ΔT decreases.

This is a common scenario. The space or process being served must be maintained at a desired temperature, limiting the maximum possible temperature of return chilled water. If the return chilled water temperature is already near its upper allowable limit, the only possible way to maintain its temperature steady is to increase the chilled water flow rate.

For this action to be viable, there must be no zone that has already achieved maximum valve opening position. If there is such a zone, raising the chilled water supply temperature will cause overheat in the zone. In case the zone gets overheated intermittently, an automatic chilled water supply temperature reset may still be a viable option.

Adoption of this technique, would minimise the chiller energy consumption and increase the pumping energy convention. However, there will be a net reduction in overall energy consumption.

Energy saving measure 2:

Integrated Waterside Economizer in chilled water plants

This has application in cases of water-cooled chiller systems with cooling towers

An Integrated Water-Side Economizer is a heat exchanger (HX) in series with the chiller.

During periods of low wet bulb temperature (often at night), the cooling towers can produce water temperatures low enough to pre-cool the chilled water returning from the facility, effectively removing a portion of the load from the energy-intensive chillers.

During the lowest wet bulb periods, the towers may be able to cool the chilled water return up to the chilled water supply temperature set point, allowing the chillers to be shut off entirely. The air handling units sense no change in chilled water supply temperature at any time, allowing them to maintain the required temperature and humidity requirements. Free cooling offers an additional level of redundancy by providing a non-compressor cooling solution for certain times of the year.

Energy saving measure 3:

Implement variable condenser cooling water flow

The standard procedure for operating water-cooled chillers is to maintain constant condenser water (CW) flow and a constant temperature of water entering the condenser, referred as condenser cooling water temperature (CCWT).

Reducing the condenser water flow will reduce pumping energy consumption. However, reducing the condenser water flow would increase the condensing temperature, causing the chiller to operate inefficiently. The lower condenser cooling water temperature will reduce the chiller condensing temperature resulting in efficient operation. The benefits must be compared against the increased cooling tower fan energy needed to produce lower condenser cooling water temperature.

The following points have to be considered to evaluate the possibility of achieving energy savings by reducing condenser water flow: .

- ▶ ASHRAE recommendation of minimum condenser water flow velocity of 1 m/s to maintain turbulent velocity and prevent formation of deposits in the condenser
- ▶ The condenser water velocity is only a small factor in the overall heat transfer. The main factor controlling refrigerant condensation is the condenser surface area
- ▶ Many chillers can operate at low condenser water flow velocities and high condenser water ΔT without affecting the stable operation of the chiller

Decreasing the condenser water flow rate will provide condenser water pump energy saving that may or may not outweigh the increased chiller energy use.

It is recommended that the condenser cooling water temperature (CCWT) should be kept as low as possible to maintain better chiller efficiency.

Energy saving measure 4:

Install an Evaporative-Cooled-condenser for chillers

Evaporative-cooled chillers are essentially water-cooled chillers in a package. The system has a condenser, water, sump and pump, etc., all as integral parts of the chiller.

The hot gaseous refrigerant is condensed by the water which flows through the condenser tubes. It facilitates the condensing temperature to be at ambient wet bulb temperature, as in water-cooled chiller.

This system improves the operating efficiency of the chiller significantly as compared to an aircooled chiller and also reduces the power consumption of cooling water pumping system.

Energy saving measure 5:

Replace old inefficient chillers with latest efficient chillers

Chillers are the major energy consumers in the cooling system. Most of the time the chillers are operated at part load conditions. The chiller performance degrades with time and operating conditions. Reduced chiller performance increases power consumption for a specific cooling load.

Table 3.3*: Latest chillers meet or exceed the minimum COP requirements

Equipment class	Minimum COP	Minimum IPLV	Test Standard
Air cooled chiller < 150TR	2.90	3.16	ARI 550/590-1998
Air cooled chiller > 150TR	3.05	3.32	ARI 550/590-1998
Reciprocating compressor, water cooled chiller all sizes	4.20	5.05	ARI 550/590-1998
Rotary screw and scroll compressor, water cooled chiller < 150TR	4.70	5.49	ARI 550/590-1998
Rotary screw and scroll compressor, water cooled chiller > 150TR and < 300TR	5.40	6.17	ARI 550/590-1998
Rotary screw and scroll compressor, water cooled chiller > 300TR	5.75	6.43	ARI 550/590-1998

Latest chillers can offer higher coefficients of performance (COP), by design, even at part load conditions.

For these reasons, it is recommended that the energy performance of all chillers be assessed periodically to estimate the cost-effectiveness of replacing old inefficient chillers with the modern efficient chillers available in the market.

3.9.2 Chilled water distribution system

Energy saving measure 6:

Convert all 3-Way chilled water valves to 2-way

Generally, chilled water distribution systems are designed with 3-way valves at the cooling coils which regulate the water flow through the coil based on the cooling requirement. A constant flow of chilled water is delivered to each coil location. Each coil is equipped with a bypass line through which the excess chilled water bypasses the coil. This method requires more energy to pump additional water into the chilled water circuit, which gets bypassed at the user end.

*Source : ECBC Code

The use of variable speed drives for pump motors would eliminate the bypass of chilled water and enable the replacement of the 3-way valves with 2-way valves. The 2-way valves would modulate flow as needed to serve the cooling load, and the pump motor speed would vary in response to the demand by maintaining a constant pressure at the far end of the distribution loop.

In facilities that experience large load fluctuation, it may be effective to program the control system to vary the pressure set point in response to the position of the most-open 2-way valve.

Energy saving measure 7:

Reduce the Chilled water supply pressure set point

Standard control system design calls for the chilled water pump serving the chilled water distribution system to maintain a constant pressure at a given location (usually at the most remote cooling coil), regardless of the current cooling load.

The pressure set point should be selected to ensure the delivery of adequate flow to every coil even during load condition considering that all the cooling coil valves are kept 100% open. The present set point may be higher than the necessary. This happens due to several reasons such as improper initial balancing; overestimation of peak load; over-aggressive load growth projections; changes made to the distribution system that weren't rebalanced; etc.

A pressure set point that is higher than necessary can cause the chilled water pump motor to draw more power than design value. Optimizing the set point for current conditions can save energy, particularly in systems where the chilled water pump is operated continuously.

For optimization the valve position is given as input to the control loop that resets the chilled water loop pressure set point to lower value until the maximum valve position equals 85% - 90% open. This control approach continually optimizes the pressure set point to reduce energy consumption.

3.9.3 Auxiliaries

Energy saving measure 8:

Convert Primary & Secondary chilled water pumping system to primary only

The typical chilled water distribution system for Datacenter facilities has a constant-volume primary loop and a variable-flow secondary loop. This arrangement ensures a constant flow through the chiller evaporator, while allowing the secondary loop to modulate flow according to demand.

In recent years, chillers have evolved to be more tolerant of variable chilled water flow through the evaporator. As a result, primary-only variable flow chilled water pumping has become more

common. This arrangement eliminates the primary chilled water pumps (the pumps previously designated as secondary become the primary pumps) which results in energy savings.

Chillers still have minimum allowable evaporator flow rates; the control system must monitor and ensure these rates. Even in facilities with relatively constant load such as Datacenters, energy savings can be realized as the constant self-balancing of the primary-only control system minimizes pump energy use.

Energy saving measure 9:

Install high efficiency pumps

Presently, pumps are available with higher efficiencies, upto 85%. Appropriate high-efficiency pumps can be selected by matching their duty point to operating parameter values such as maximum head and flow requirements in the pumping system.

Estimate the operating parameters such as maximum head and flow requirement and select a high efficient pump matching its duty point close to the operating values.

Energy saving measure-10:

Calibrate Chilled Water (CHW) supply temperature sensors annually

Chiller efficiency is highly dependent on chilled water (CHW) temperature and ambient conditions.

A low chilled water supply temperature typically results in lower chiller efficiency, with other factors remains constant. An error in the chilled water supply temperature sensor can cause a chiller plant to produce chilled water at low temperature which may not be required and increase the energy consumption. In addition, a too-cold chilled water temperature can cause undesired dehumidification at the cooling coils. This places an extra load on the cooling system and additional energy use.

Therefore, it is recommended to calibrate the sensors periodically, preferably on an annual basis.

Energy saving measure 11:

Calibrate the Condenser Water (CW) supply temperature sensors annually

The temperature of the condenser water (CW) entering the condenser has major effect on chiller efficiency. A higher condenser water supply temperature typically results in lower chiller efficiency, with other factors being constant.

An error in the condenser water supply temperature sensor can cause the cooling towers to produce warmer condenser water than desired and in turn cause inefficient operation of the chiller plant. Hence it is recommended to calibrate the condenser water supply sensors annually.

Energy saving measure 12:

Utilize the entire area in the cooling towers to improve their energy performance

By operating all cooling tower cells as possible at all times, the amount of water to be cooled is distributed across more number of cells. This decreases the amount of heat rejection required in each cell, which in turn reduces the fan speed, resulting in energy saving. However, care must be taken that no cell starves for water.

Energy saving measure 13:

Install Cooling Tower with low Approach Temperature

Every cooling tower can produce a water temperature that approaches, but never lower than the ambient wet bulb temperature. The difference between these two temperatures is called the 'approach' temperature.

During operation, the approach temperature will vary as a result of several factors – the tower water flow rate, the temperature of the water entering the tower, the current wet bulb temperature, the cooling tower fan speed, etc. Manufacturers report the approach temperature at a single specific operating condition.

A tower with a smaller approach temperature is more efficient as the cooling water temperature is lower leading to improved chiller efficiency.

Selecting and installing a cooling tower with a low approach temperature is recommended.

Energy saving measure 14:

Measure the Return Temperature Index (RTI) and Rack Cooling Index (RCI)

A low air temperature rise in the Datacenter IT equipment clearly indicates the inefficiency in air management.

A low return temperature is due to by-pass air and due to recirculation air. Estimating the Return Temperature Index (RTI) and the Rack Cooling Index (RCI) will indicate the necessity of corrective actions.

The Rack Cooling Index (RCI) is a measure of how well the system cools the equipment within the manufacturers' specifications, and the Return Temperature Index (RTI) is a measure of the energy performance of the air-management system

Other methods proposed to quantify cooling effectiveness are Supply Heat Index (SHI), dimensionless indices to quantify the extent of return air with supply air and also the extent of bypass of supply air to the return airstream.

It is recommended to monitor Return Temperature Index (RTI) and Rack Cooling Index (RCI) to maintain energy performance of the cooling system.

Energy saving measure 15:

Increase the supply air temperature as per ASHRAE recommendations.

A low supply air temperature makes the chiller system less efficient and limits the utilization of economizers. Enclosed architectures allow the highest supply temperatures since mixing of hot and cold air is minimized.

In contrast, the supply temperature in open architectures is often dictated by the hottest intake temperature.

Target the maximum recommended intake temperature from guidelines issued by ASHRAE (77°F) depending on the type of electronic equipment. If the air distribution system can be modified to deliver air more effectively to the equipment, it may be possible to raise the average intake temperature. This in turn will allow the cooling supply air temperature to be raised, which typically results in a more efficient cooling system operation.

Energy saving measure 16:

Provide Temperature and Humidity Sensors to Monitor IT Equipment air intake Conditions

IT equipment manufacturers design their products to operate reliably within a given range of intake temperature and humidity. The temperature and humidity limits imposed on the cooling system that serves the Datacenter are intended to match or exceed the IT equipment specifications. However, the temperature and humidity sensors are often integral to the cooling equipment and are not located at the IT equipment intake points. The condition of the air supplied by the cooling system is often significantly different by the time it reaches the IT equipment intakes. It is usually not practical to provide sensors at the intake of every piece of IT equipment, but a few representative locations can be selected.

Adjusting the cooling system sensor locations in order to provide the cooling that is needed at the IT equipment intake points often results in more efficient operation.

Energy saving measure 17:

Calibrate Temperature and Humidity Sensors annually

Temperature sensors generally have good accuracy when they are properly calibrated (+/- a fraction of a degree), but they tend to drift out of adjustment over time. In contrast, even the best humidity sensors are intrinsically not very precise (+/- 5% RH is typically the best accuracy that can be achieved at reasonable cost). Humidity sensors also drift out of calibration.

To ensure good cooling system performance, all temperature and humidity sensors used by the control system should be treated as maintenance items and calibrated at least once a year.

After a regular calibration program has been in effect, monitor and gauge the drift in sensors to estimate the required frequency of calibration. Calibrations can be performed in-house with the proper equipment, or by a third-party service.

Energy saving measure 18:

Provide personnel and Cable Grounding to Allow Lower IT Equipment Intake Humidity

Higher humidity levels results in increased energy consumption of cooling system in Datacenter. Conversely, the lower humidity limit in Datacenters is often set relatively high (40% RH at the IT equipment intake is common) to guard against damage to the equipment due to Electro Static Discharge (ESD).

Energy can be saved if the allowed lower humidity limit can be lowered. ESD can be kept in check by conductive flooring materials, good cable grounding methods, and providing grounded wrist straps for technicians to use while working on equipment.

3.9.4 Energy Conservation measures in Datacenter Air Management

Energy saving measure 19:

Ensure Adequate Match between Heat Load and Raised-Floor Plenum Height

The cooling capacity of a raised floor depends on its effective flow area, which can be increased by removing cables and other obstructions that are not in use. Still, the heat density may need to be reduced. Undersized and/or congested plenums often require an overall elevated static pressure to deliver the required airflow. Providing increased static pressure requires additional energy consumption in fan.

Energy saving measure 20:

Provide Adequate Ceiling Supply/Return Plenum Height

The plenum height can be increased if a clear ceiling allows it. A return plenum often means a lower clear ceiling but allows the placing of return grilles directly above the hot aisles. Such a plenum needs to be maintained like a raised floor. A shallow plenum may result in high pressure losses, poor pressure distributions, and high fan-energy costs.

Energy saving measure 21:

Remove Abandoned Cables and Other Obstructions

Under-floor and overhead obstructions often interfere with the distribution of cool air. Such interferences can significantly reduce the air handlers' airflow as well as negatively affect the

air distribution. The cooling capacity of a raised floor depends on its effective height, which can be increased by removing obstructions that are not in use.

Energy saving measure 22:

Implement Alternating Hot and Cold Aisles

This is the first step towards separating hot and cold air, which is a key to better air management. As cold air is supplied to the front aisles, the electronic gear moves the air from the front to the rear and to the top, and the hot exhaust air is returned to the CRAC from the rear and/or top aisles. However, some Datacenters are not suitable for hot/cold aisles, including those with non-optimal gear (which do not move air from the front to the rear/top)

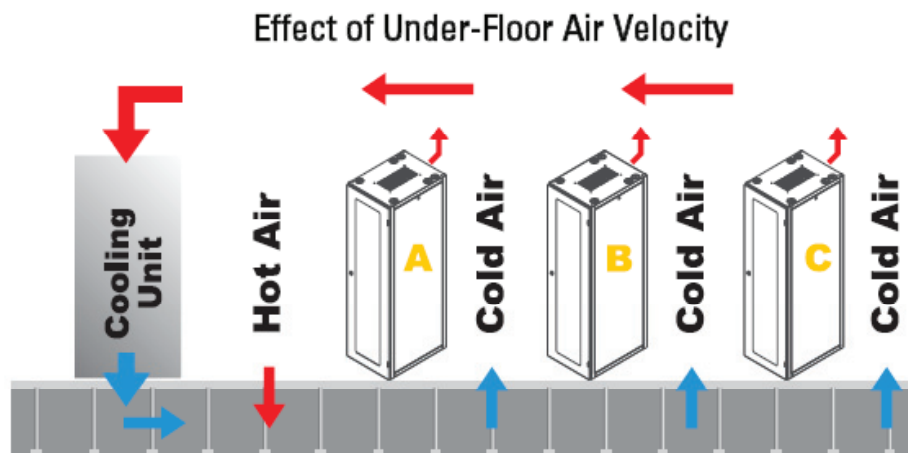

Figure 3.6a: Hot aisle & Cold aisle containment

Energy saving measure 23:

Provide Physical Separation of Hot and Cold Air

Physical barriers can successfully be used to avoid the mixing of hot and cold air, allowing reduction in airflow and fan energy consumption as well as increasing supply / return temperatures and chiller efficiency.

There are four principal ways of providing physical separation:

- › Semi-enclosed aisles such as aisle doors, which allows containment of the cold air. Blanking panels should be used to seal openings under and between equipment racks, and between equipment shelves in partially filled or empty racks
- › Flexible strip curtains to enclose aisles; these allow a satisfactory separation of hot and cold air
- › Rigid enclosures to enclose aisles; these allow excellent separation of hot and cold air
- › In-rack ducted exhausts; allow effective containment of the hot exhaust air

Energy saving measure 24:

Provide perforated tiles or diffusers in Cold Aisles

Perforated floor tiles or over-head supply diffusers should only be placed in the cold aisles to match the “consumption” of air by the electronic equipment. Too little or too much supply air results in poor overall thermal and/or energy consumption conditions.

Note that the hot aisles are supposed to be hot, and perforated tiles should not be placed in those areas.

Energy saving measure 25:

Design the Return Air from Hot Aisle area

The thermal efficiency of the Datacenter increases when the return temperature is maximized. The closer the return is located to the heat source, the better. If a return plenum is used, the grills should be placed directly above the hot aisles.

Energy saving measure 26:

Provide Adequate Floor Plenum Pressure

A high static pressure often results in high floor leakage and by-pass air. A moderate static pressure (0.05 in. of water) allows relatively high tile airflow rates inducing minimum floor leakage.

In case the standard 25% perforated tile does not deliver enough airflow to cool the equipment at moderate pressure, it is better to increase the tile open area than to increase the pressure.

Energy saving measure 27:

Balance the Air Distribution System

Over-head ducted systems can be adequately balanced using conventional methods whereas raised-floor systems are balanced by providing the required number of perforated tiles. The amount of cold air required at each rack should be supplied by placing the adequate number of tiles in front of racks.

Energy saving measure 28:

Remove Doors from IT Equipment Racks

The use of doors often obstructs the cooling airflow and may result in recirculation of cooled air within the enclosed cabinet. This would further increase the equipment intake temperature.

If rack doors are necessary for security reasons, sufficient openings should be provided in the doors to permit adequate airflow through it.

Energy saving measure 29:

CFD analysis for better air management

Optimizing Cooling performance for a Datacenter is a challenging task. Several factors affect the airflow distribution and the cooling performance of a Datacenter. Physical measures and field-testing are time and labor Intensive. In such situation, Computational Fluid Dynamics (CFD) simulations provides a feasible alternative for testing various design layouts and configuration in a relatively short time.

CFD can predict the air velocities, pressure, and temperature distribution in the entire Datacenter facility. A good design of layout and equipment can contribute upto 30% saving in operational energy consumption.

Energy saving measure-30:

Switch off CRAC/CRAH Units

In case of low heat load on all the CRAC units, some of the CRAC units can be turned off. Few of the OEM focus on advance options with the use of intelligent controllers. It enables the function of multiple units in team mode configuration and optimizes the energy consumption. The operational control for the units can be set by the operating personnel.

Experimentation may be required to determine the units to be operated in ON/OFF mode without compromising on the cooling of the IT equipment

Energy saving measure-31:

Control all supply fans parallely

If all the supply fans serving a given space are identical and equipped with variable speed drives, fan energy is minimized by running all the fans (including redundant units) at the same speed

Energy saving measure-32:

Install CRAC units with EC fans

When replacing older units, new units that use EC fans for air movement application should be insisted upon. EC fans provide electronic control to vary the air flow rate and maintain the required temperature at the IT equipment. They use the minimum energy for operation compared to other air movement equipment available in the market.

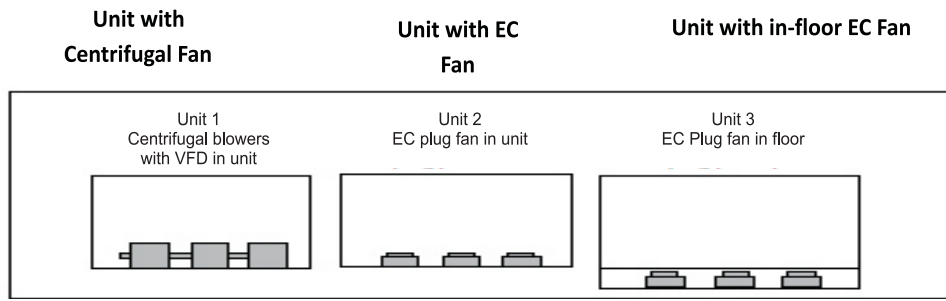

Figure 3.6b : Positioning of EC Fans

Energy saving measure 33:

Install rack with low self weight

Since the raised floor load bearing capacity is constant, for space optimization it is important to have low self-weight which eventually can accommodate more no. of servers. On the power side, this arrangement cuts down the no. of rack Power feeder lines. To tackle increased cooling, such rack should also enhance airflow management across server by having higher door perforation (Up to 83 %) & in rack hot & cold air separation by using blanking panels & brush strips. Hence, this arrangement address issues related to space and energy consumption.

Energy saving measure 34:

Install CRAC units with Dynamic Capacity Modulating Compressor

Dynamic capacity modulating compressor technology gives a wide range of advantages over standard compressors. A modulating compressor works at very different partial loads by modulating its capacity ranging from 10% to 100% without the use of an external inverter. This unique technology enables immediate reaction to every change identified in load requirements and thus offers better energy saving in dynamic load environment.

The graph below illustrates the typical expected operating load requirement at the inception & Increasing Heat densities in future:

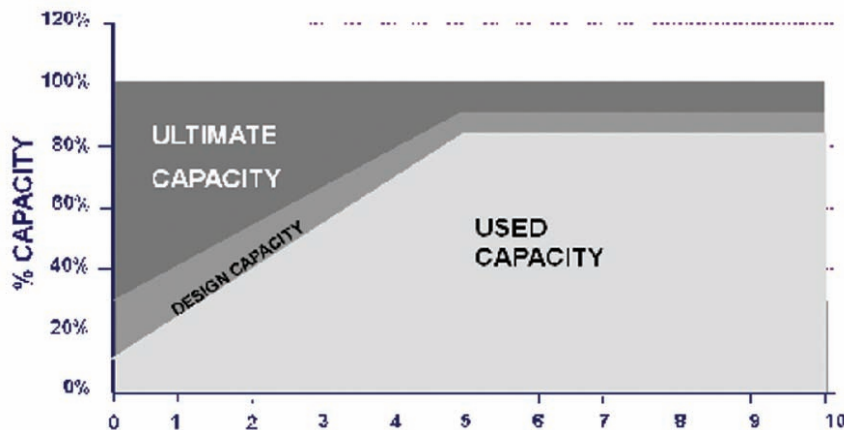

Figure 3.6 c: Capacity utilization chart

So the dynamic capacity modulating compressor takes care of the requirement in a energy efficient manner over a larger period.

Energy saving measure-35:

Optimizing Airflow

It is quite important to know that about 12-14% of the total power consumption is used for Airflow while cooling a data centre. So, due concentration is to be given towards optimizing the Airflow within the data centre space by:

- › Reducing the airflow obstacles/restrictions to save energy
- › Minimizing the short-circuiting between hot and cold air by using blanking plates where appropriate
- › Proper placement of racks is important to reduce short-circuiting of hot and cold air. Therefore, we need to arrange the racks in hot-aisle /cold-aisle configuration. High-density racks are to be placed at the centre of the rack
- › Place cooling unit at the end of the hot aisle for better control of return air temperature
- › Improve vapor barrier i.e. unnecessary humidification/dehumidification is avoided to minimize the energy waste
- › Focus on reducing the solar heat gain by checking on air leakages in the room under floor & ceiling to further minimize energy waste

Today, there are companies that offer solutions that optimize the airflow and take care of each aspect towards increasing overall efficiency of a data centre

Energy saving measure-36:

Using Economizers appropriately

In many locations, outside cool air can be used to supplement Datacenter cooling and provide “free cooling” during colder months. This is accomplished by using economizer systems.

The Energy Usage Intensity (EUI) of buildings with economizers was 13 percent lower than those without economizers.

Energy saving measure-37:

Bringing cooling closer to the source of heat

The cornerstone of an effective cooling strategy is to take care of every possible heat load in a Datacenter, but due to rapid increase in technology & heat loads, the dependence solely on conventional mission-critical cooling systems to resolve such high heat densities is not possible. Hot spots or zones require targeted cooling solutions. In addition, for extremely high heat loads, conventional approaches may simply take up too much floor space to make it possible.

Supplemental cooling is a relatively new approach to Datacenter cooling and this has been gaining rapid acceptance as Datacenter managers seek solutions to help them to:

- › Overcome cooling capacity limitations of raised floor systems in high heat density applications
- › Increase cooling system efficiency and flexibility

Overhead coolers can be located over the rack and/or at the center of the cold aisle receiving hot air from the hot aisle and supply the cold air into the cold aisle.

Thus, supplemental cooling solutions are space saving as well as provide low risk & increased reliability for the today's Datacenters.

Together, these methods can reduce cooling system energy costs by 30 to 45 percent and generate significant, recurring saving.

Presently, the main objective of IT vendors is to crunch-in more and more compute capability in the available small space. As discussed earlier, gradually the heat density of Datacenters is increasing. There is also indiscriminate increase in power tariffs. Therefore, increase in the operational expenditure is certain. Thus, reduction in energy consumption and increasing energy-efficiency are the important aspects to focus on for Datacenter managers.

Case Study 4

POTENTIAL BENEFITS OF ECONOMIZER IN COOLING SYSTEM

Background

A precise control of temperature and humidity control is essential for efficient Datacenter operation. The increasing energy costs challenge engineers to find the most cost-effective ways to control temperature and humidity within acceptable ranges.

The use of economizer systems is one method that has been adopted to lower energy usage, lessen wear and tear on precision air conditioning equipment and decrease operational costs.

Economizer systems are designed to utilize outdoor favorable weather to supplement the cooling requirements and provide so-called “free cooling” cycles for computer rooms and Datacenters. The economizer system minimizes or eliminates the operation of mechanical cooling system.

Economizer using ambient air

The economizer uses fresh air directly to supplement the mechanical cooling system. The system requires hot aisle configuration while the air from the hot aisle would be taken to outside through ducting under the specified economizer operating condition.

It would be possible to remove the entire heat generated by supplying high volume of fresh air, if it satisfies the required supply air conditions.

The economizer would be operated at three different conditions based on the ambient air conditions, and are discussed below.

Case-1: Fresh air temperature higher than return air temperature

The system fully operates with mechanical cooling system. Since the outside air temperature is higher than the return air temperature. There will be no use in bringing the fresh air inside.

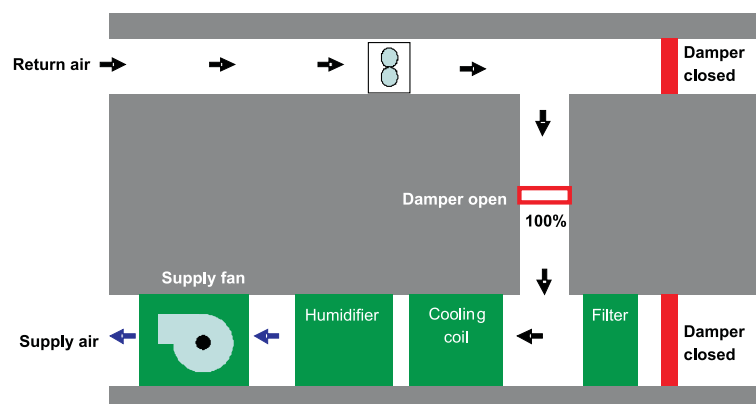

Case-2: Fresh air temperature between supply and return air temperature

The system would operate with full fresh air drawn from ambient since the outside air is cooler than the return air from the hot aisles. The load on the mechanical cooling system will be directly proportional to the fresh air temperature i.e. at 27°C it will be 100%, at 22°C it will be 50% and 17°C it will be 0%.

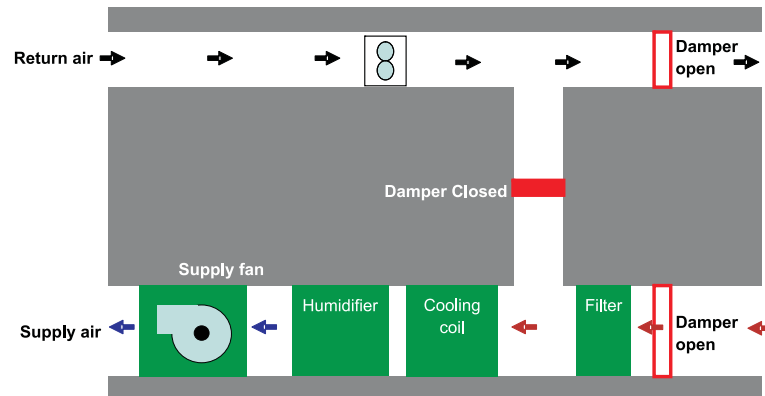

Case-3: Fresh air temperature lesser than supply air temperature

In this case, the supply air will be the mix of fresh air and the return air. Since the fresh air is cooler than the required temperature of supply air, the control dampers are modulated to mix proportionate amount of fresh air with return air.

If the relative humidity of the return air drops to 20%, then the humidifiers will be run in order to maintain this percentage as a minimum.

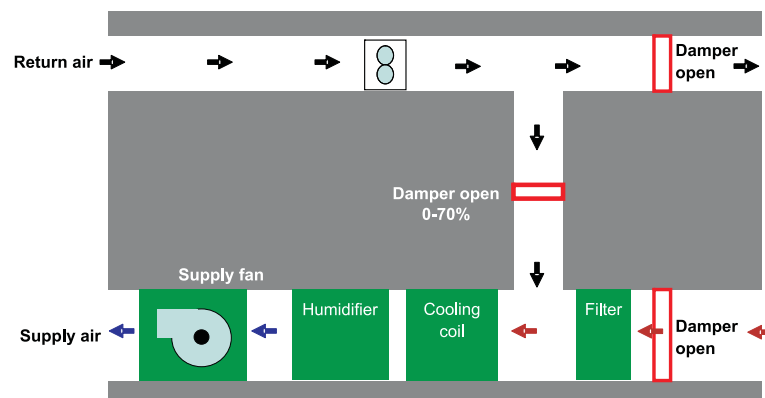

Fluid based Economizer

The stringent temperature and humidity requirements of Datacenters coupled with the need for continuous cooling makes the fluid-based economizer system one of the choices for most Datacenters environment.

The ultimate goal of both air-side and fluid-side economizer systems is to provide “free cooling” to the facility, thus reducing the operating time of the mechanical cooling system.

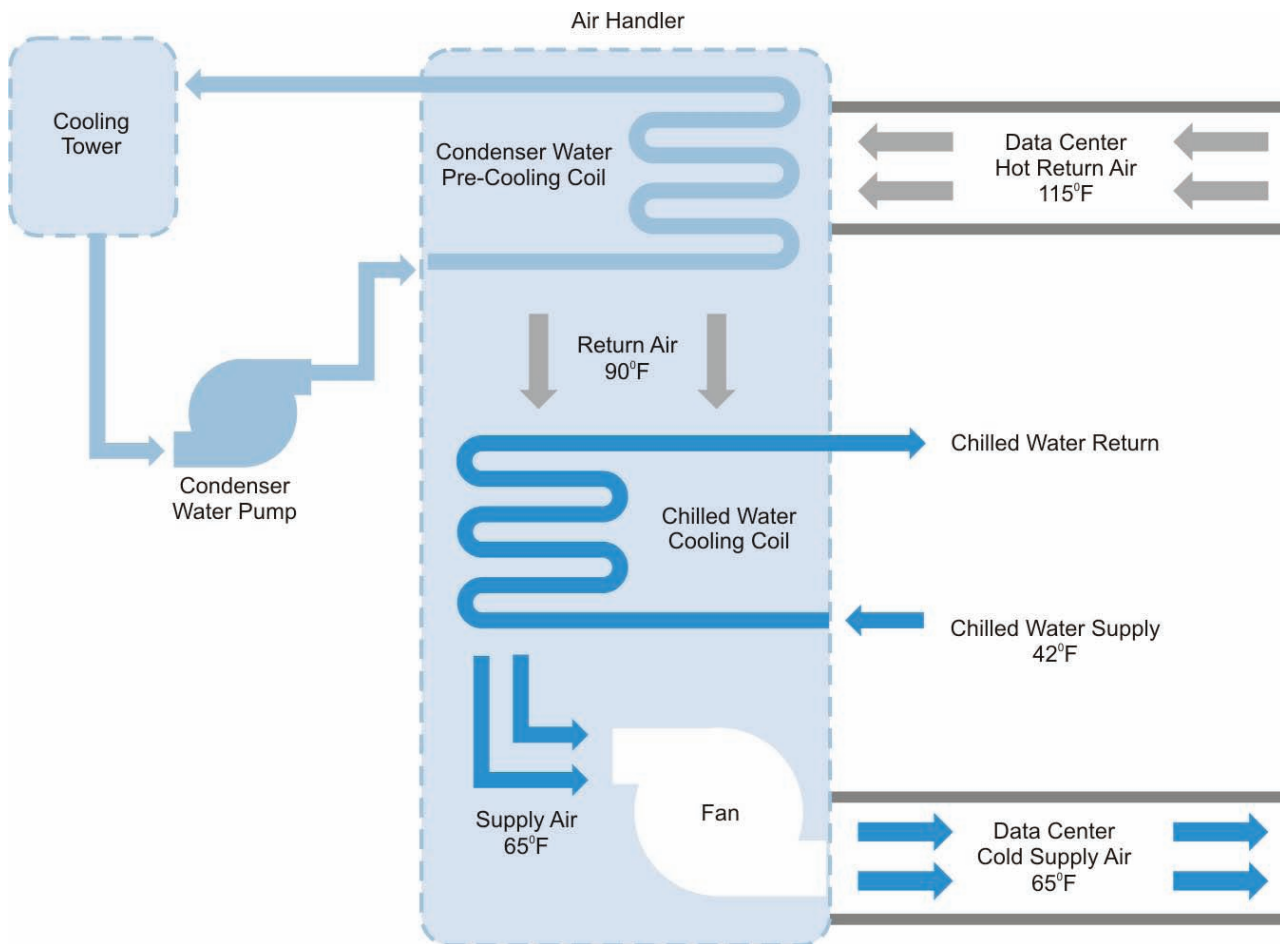

Figure 3.7: Schematic of Fluid based economizer

In certain geographical locations, economizers can satisfy a large portion of Datacenter cooling requirements. The use of economizer systems can have a significant impact on energy usage.

In a fluid based economizer, the warm return air from Datacenter enables effective transfer of heat from air to water maintained at temperatures close to wet bulb temperature. As the heat transfer is proportional to the temperature difference between cooling water and return air, more heat transfer takes place in the AHU. As a result, cooling capacity of the air handling coils increases dramatically.

The pre-cooled return air is again cooled to required temperature through chilled water system. Since the return air is pre-cooled with cooling water the cooling requirement on chilled water system reduces and minimizes the load on chiller.

Project details

One of the leaders in precision air conditioner manufacturers implemented the project with the fluid side economizer in the Datacenter deployed with high density IT equipment and blade servers.

Blade servers generate more heat than traditional 1U servers and uses less specific quantity of air for cooling, less airflow per watt of heat generated, which results in higher temperature difference (ΔT) across the server. Higher temperature difference results in higher return air temperature.

For a blade server operating at peak utilization, the cooling air entering at 18°C could exit at 46 to 52°C. As all the servers was not simultaneously operated at peak utilization, the return air temperature was of the order of 43°C, which is still warmer compared to a typical Datacenter.

Fluid-side economizer systems use the cold outside air to cool the water/ glycol loop, which in-turn cools the chilled water. The chilled water is then circulated in the cooling coils of the critical cooling system.

Figure-3.8 shows the ambient temperature envelope of operation for this type of system, which has no restrictions for ambient temperatures under 65° F since the outside air is not introduced into the space.

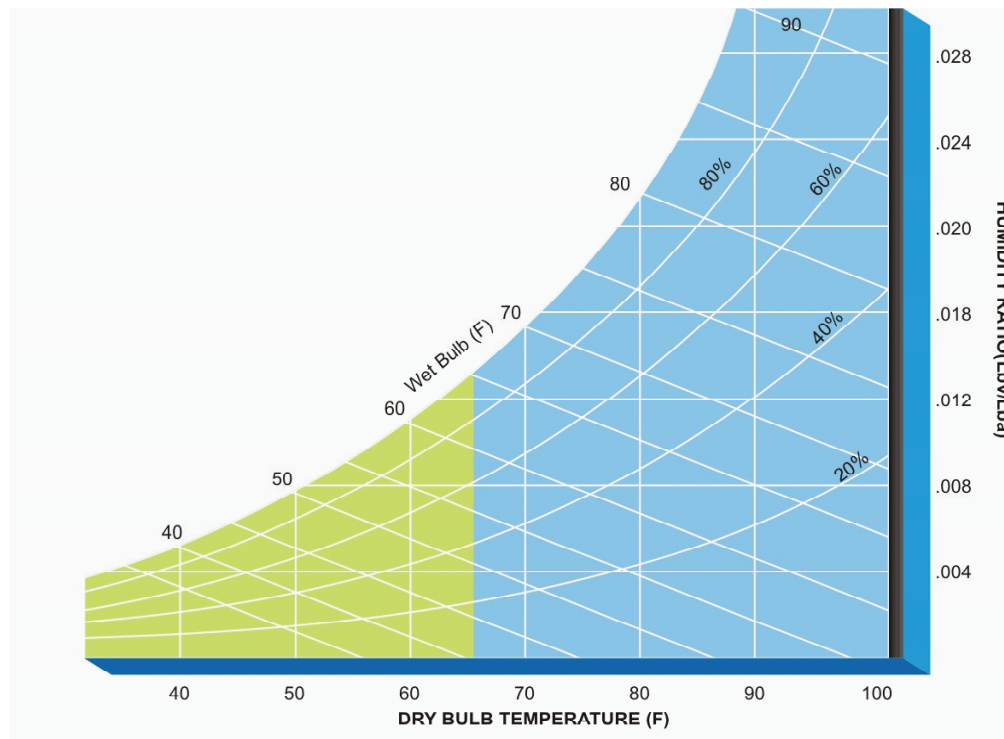

Figure 3.8: free cooling circuit (waterside economizer) operating range –Computer application

Results of the project

There was a substantial reduction in power consumption of chiller and HVAC effectiveness increased from 3.57 to 7.29. HVAC effectiveness is the ratio of IT equipment power to total cooling system power.

Case Study 5

INTRODUCTION OF INTELLIGENT CONTROLLER FOR MULTIPLE COMPUTER ROOM AIR CONDITIONER (CRAC) SYSTEM

Background

Most of large Datacenters are equipped with multiple CRAC units to cater the cooling load requirement. Normally, the CRAC units operate in a decoupled fashion, where the units are controlled by its localized feed back sensor. Under such conditions, the control of humidity level becomes complex. For instance, two CRAC units might fight each other; one CRAC unit would dehumidify the air while the other unit would humidify the air, to control the overall humidity level. This leads to the problem of continuous operation of both CRAC units consuming more energy.

The problem can occur due to the following reasons.

- › If the return air to the two CRAC units is at slightly different temperatures
- › If the calibrations of the two humidity sensors disagree
- › If the CRAC units are set to different humidity settings

The problem can be solved by using an intelligent controller system to control the operation of all CRAC units.

Measures

The intelligent controllers can be set to operate in any of the following modes to optimize the operation of all CRAC units.

Teamwork mode

During balanced load conditions units can be grouped together connected to network & can be set up to work together in a teamwork mode. In this teamwork mode most of the parameters are shared; if set in any one of the units, all other units will follow with the same settings.

The “Master” unit determines the intense of operation to perform. The master unit evenly distributes the load among the number of available units.

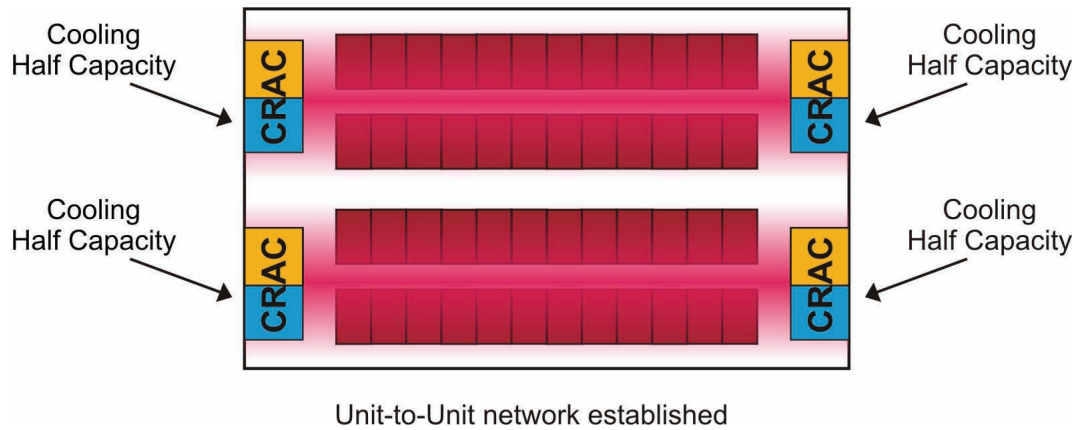

Figure 3.9 a: Capacity utilization in Team mode operation

This mode is designed to prevent units within a group from working against each other or “fighting.” It is best applied in large rooms with unbalanced heat loads. Team defines operation but each unit determines how intensely to perform the operation.

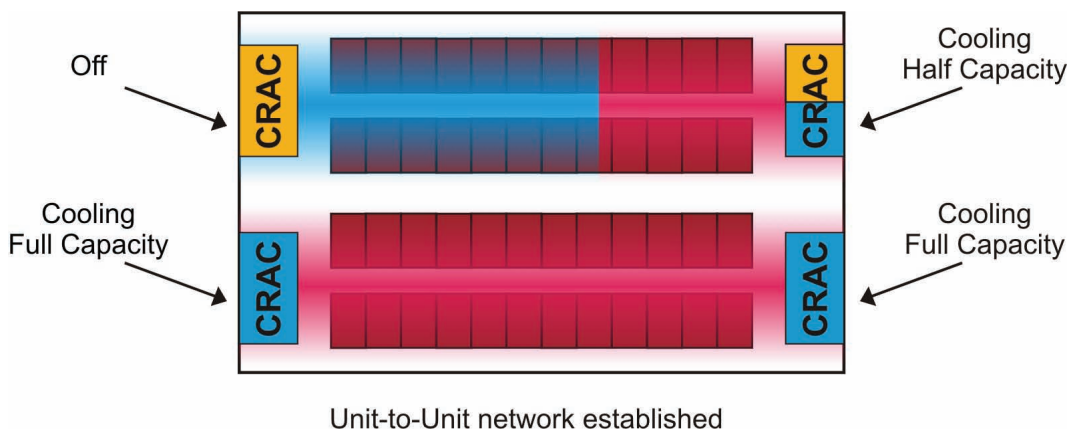

Figure 3.9 b: Capacity utilization in Team mode operation

Cascade

The Cascade Operation function allows additional units to be staged-on based on the temperature or humidity requirement. If the active units cannot regulate the room temperature or humidity level, standby units activate automatically to regain its control of the space.

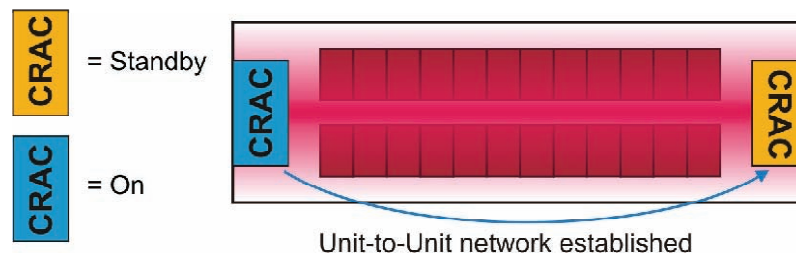

Figure 3.9 c: Capacity utilization in Team mode operation

Lead/Lag

The Standby (Lead/Lag) function allows one or more units to be set as “Running” and “Standby” for activation in case of an alarm. The standby units get activated automatically when there is alarm occurs in the primary unit.

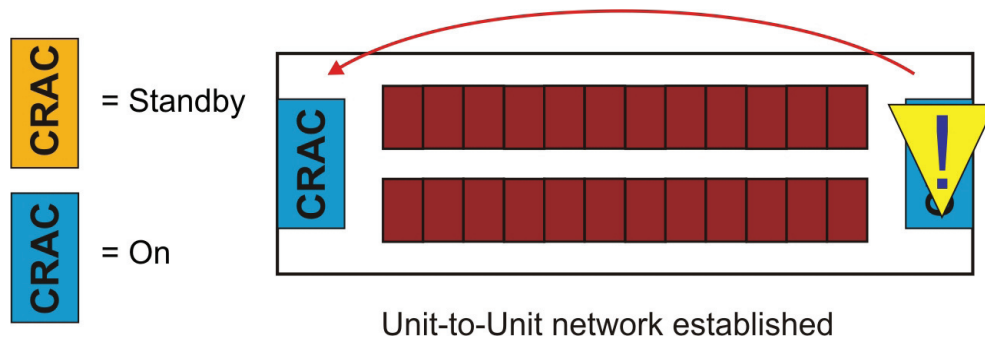

Figure 3.9 d: Capacity utilization in Team mode operation

Higher dead band settings

Setting the CRAC units to operate at higher dead band ranges can avoid the operational overlap of humidifiers in adjacent CRAC units. The dead band humidity setting should be at least $\pm 5\%$.

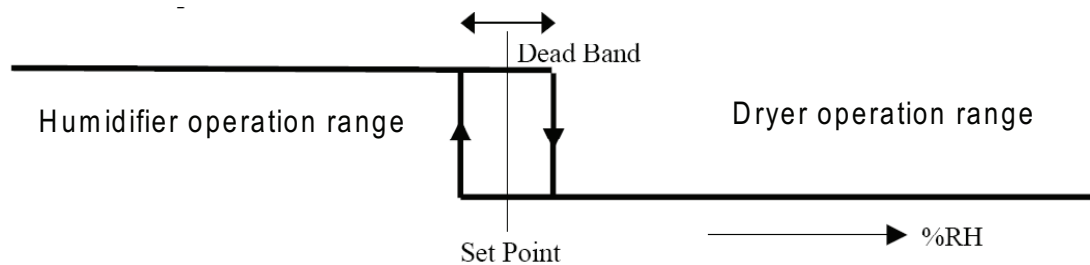

Figure 3.9 e: Dead band setting

Each of these techniques has advantages, which are not discussed in detail in this manual. The easy way to solve the problem is to verify that the cooling systems are set to the same settings and are properly calibrated.

The project involves fine tuning the existing cooling system. The project does not require any capital investment. The project can be taken up by the in-house maintenance team

Case Study 6

BENEFITS OF ELECTRONICALLY COMMUTATED (EC) FANS FOR VARYING AIR REQUIREMENT

The Datacenter cooling system is a primary target for energy efficiency improvements. Air management is one of the critical areas in Datacenter cooling systems.

The supply air requirement is based on the heat load and also depends upon the operation of the Datacenter. It becomes difficult to vary air movement in Datacenter by using conventional centrifugal fans. Electronically commuted (EC) fan is the latest system for varying air movement application in the Datacenter.

EC fans consume up to 15% less power than the conventional centrifugal fans by design. The EC fans have high efficiency across a wide speed range, whereas the efficiency of the centrifugal fans rapidly drops with decreasing speed. At partial load range, the benefit of the EC technology gets more prominent.

The efficiency of the EC motor (typically > 90%) is higher than that of traditional asynchronous AC motor (typically < 80%) and generates less heat, as there are no slip losses and less copper & iron losses.

Advantages with EC Fan:

- ▶ High efficiency, External rotor EC Motor with integrated Electronics
- ▶ No belt losses
- ▶ True soft start characteristics (inrush current lower than operating Current)
- ▶ Maintenance free design & construction
- ▶ Back Ward curve , Corrosion resistance aluminum Wheel

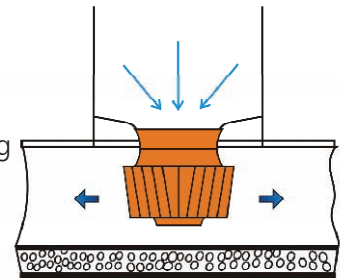

Figure 3.10a: Unique "In-Floor" Configuration

Technical details:

On chilled water cooling units, the fan consumes the maximum the energy usage. Using electrically commutated (EC) plug fans provides option for improving energy efficiency by controlling the fan speed.

If cooling units are oversized, the fan speed can be reduced. The motor power varies with the cube of the motor speed.

For example, a 10 percent reduction in fan speed results in an energy savings of 27 Percent. A 20 percent reduction in fan speed results in 49 percent energy saving. In order to prevent over-dehumidification, the water flow rate to the chilled water coil should also be reduced by the same percent as the fan speed.

$$\text{Motor kW2} = \text{Motor kW1} * (\text{speed2}/\text{speed1})^3$$

Based on the study, the following observations were made.

Scenario 1: Centrifugal Blowers vs. EC Plug Fan Mounted in the Unit

	Precision Unit, 72F/50% RH, 45EWT, 10 deg water TD, 0.3" Externalstatic	Net Sensible Cooling Capacity (KBTUH)	Motor KW	EER	CFM	Saving from Base
100% Speed	Centrifugal blowers w/VFD	284	11	25.8	17,000	-
	EC motorized impellar	291	9	32.3	17,000	-18.20%

Using ASHRAE 127-2007, the tested EC plug fans mounted inside the precision air conditioning units draw 18.2 percent less power than the tested centrifugal fan.

Scenario 2: Centrifugal Blowers vs. EC Plug Fan Mounted in the Unit vs. EC Plug Fan Mounted Under the Unit

	Precision Unit, 72F/50% RH, 45EWT, 10 deg water TD, 0.3" Externalstatic	Net Sensible Cooling	Motor KW	EER	CFM	Saving from Base
100% Speed	Centrifugal blowers w/VFD	284	11	25.8	17,000	-
	EC motorized impellar	291	9	32.3	17,000	-18.20%
	EC plug fan under floor	296	7.6	38.9	17,000	-30.90%

Mounting EC plug fans under the Floor is approximately 12 percent more energy efficient than mounting the EC plug fan inside.

The energy analysis: (EC Fan configuration details)

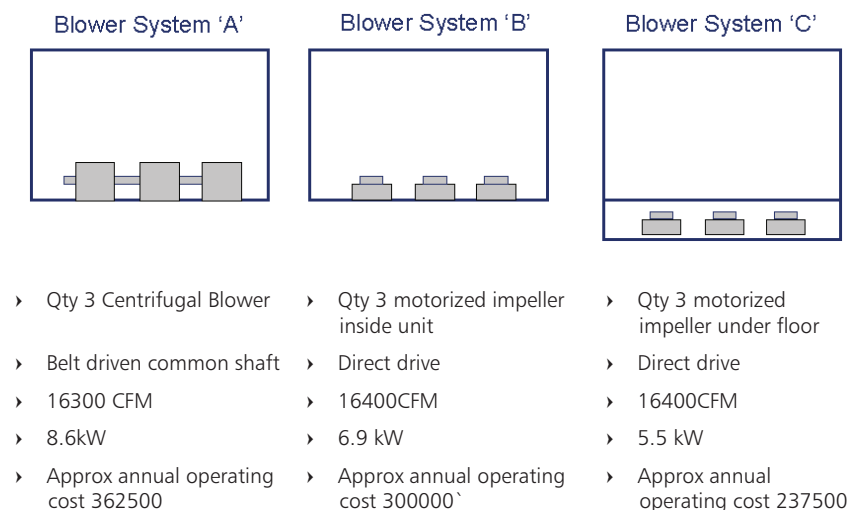

Figure 3.10 b: EC Fan configuration details

Cost of Power is Rs. 5 per kWh & operation at 80 % fan speed.

Replication potential

The project has a high replication potential and can be done at the designing stage of the project.

Cost Benefits of the project

- Annual benefits of Saving of Opex
- Reduction in power consumption
- Improved efficiency & reliability

- The advantages of Electronically Commutated (EC) fans for CRAC units are applicable in all types of Datacenter
- The project has to taken up during the design stage of the cooling infrastructure

Case Study 7

POTENTIAL BENEFITS OF HOT AISLE/COLD AISLE CONTAINMENT

Background:

Modern IT equipment takes in cold air through the front and exhausts hot air out of the back.

For example, if the front of the servers and the front of the rack shares the same orientation, then the user has achieved a consistent airflow direction throughout the row of racks. However, if several parallel rows of racks are set up in the same orientation, a significant cooling problem arises, as the hot exhaust air from the first row is sucked into the “cool” air intakes of the servers in the second row of racks. With each progressive row, the air temperature gets hotter and hotter as hot air passed from one row of servers down to the next as represented in the figure below.

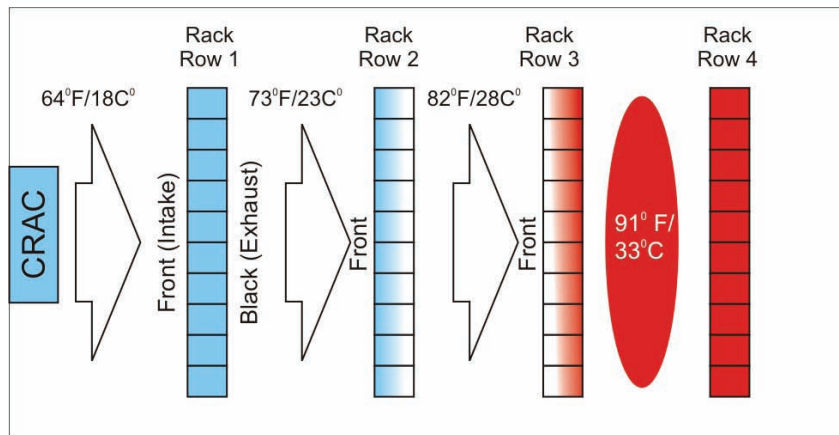

Figure 3.12a: Temperature difference of air to the server racks

To maintain the server inlet air temperature at farthest row, the overall supply air temperature has to be maintained very low. Providing low temperature air increases the cooling requirement and thus increases the operating cost of Datacenter.

Apart from that, the condition is worse when significant hot and cold air mixing occurs in the Datacenter. Because the lower temperature air returning to the CRAC unit loses more moisture in the cooling process than the warmer unmixed air would. This requires continuous humidification process to maintain the humidity level inside the Datacenter. The continuous humidification and dehumidification process reduces the useful work done by the CRAC/CRAH units.

To overcome the issue, the rows of racks should be oriented so that the fronts of the servers face each other. In addition, the backs of the rows of racks should also be facing each other. Such orientation of rows layout is referred to as “hot aisle / cold aisle” system. Such a layout, along with cold air containment can greatly reduce energy losses and prolong the life of the servers.

Various containment and segregation techniques can help minimize the mixing of hot and cold air. Simple devices such as blanking panels (which fill spaces between rack-mounted equipment), air dams (which seal the top, bottom, and sides of equipment), and brush grommets, as shown in Figure 3.12b (which can fill open spaces around floor cable cut-outs, and barriers or cabinet chimneys to contain hot return air) can help contribute to better air management and improve the cooling efficiency.

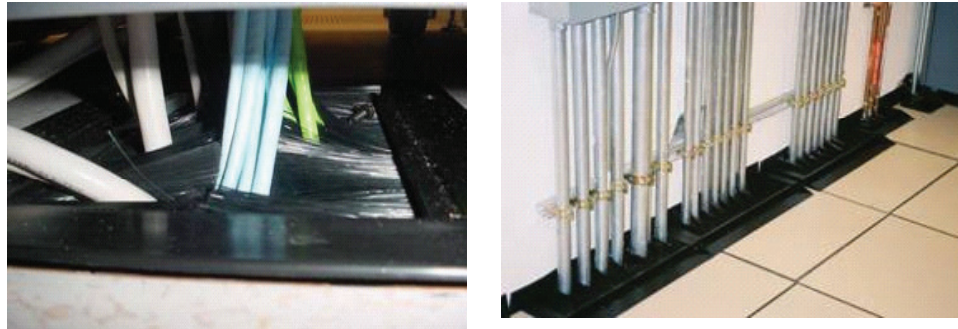

Figure 3.12 b : Installation of brush grommets

Advanced approaches such as hot aisle or cold aisle containment can minimize the mixing of hot and cold air to a large extent. Such strategies allow airflows to be more predictable.

Even Greater Efficiencies achieved can be by Integrating the Cold Aisle Containment Unit to the CRAC. The integration ensures more than 30% Reduction in CRAC Energy Consumptions.

Higher efficiency can be achieved by integrating the Cold Aisle Containment Unit with the CRAC. The integration ensures a reduction of more than 30% in CRAC unit energy consumption.

The savings realized would be more if the system satisfies the following criteria:

1. The volume of air in the contained area should be equivalent to the air volume required by the IT equipment to remove the heat generated
2. The inlet temperature of the IT equipment should be set at around 22-23°C

This can be achieved by adopting modulating EC Fan and Digital Scroll compressors (Direct Expansion CRAC) / Water Flow (Chilled Water CRAC) through sensor Integration.

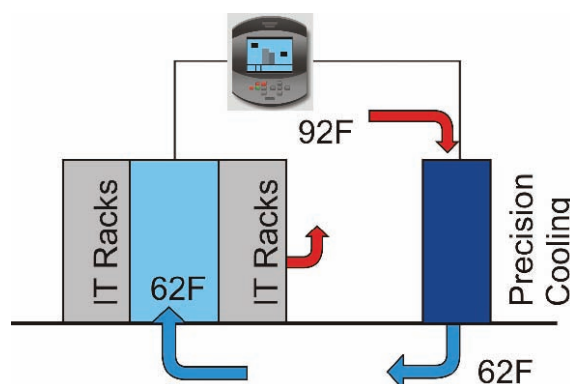

Figure 3.13: CAC with Intelligent Controller

The following figure 3.13b depict the fluid dynamics change due to implementation of cold aisle containment. One can visibly see the uniform temperature separation.

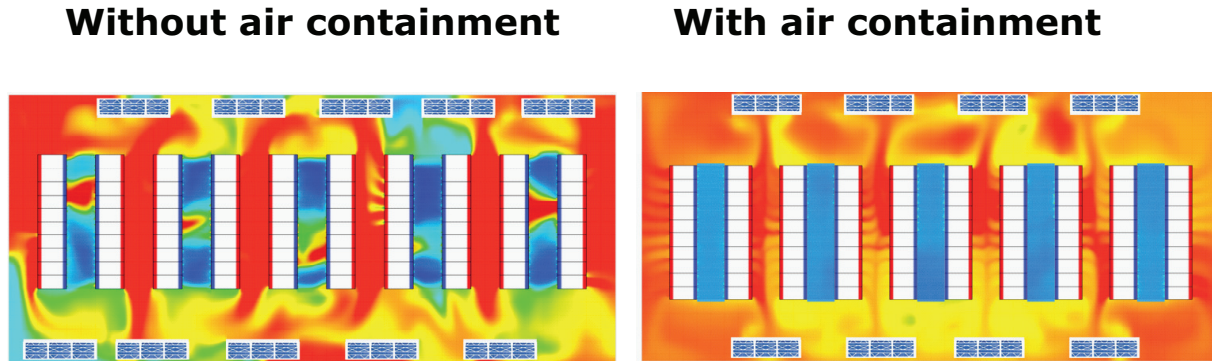

Figure 3.13b: CFD Analysis

The following table depicts the savings observed with CAC implementation in both DX based systems and in Chilled water based systems:

Table 3.4: Savings observed with CAC implementation

		Traditional Approach	With Aisle Containment	With Integrated CAC
Savings Direct Expansion system	Compressor	69.7%	50.9%	50.4%
	Condenser	9.3%	9.3%	9.3%
	Evaporator Fan	21%	18.5%	7.2%
	Total	100%	78.7%	66.9%
	Savings		21%	33%
Savings Chilled water system		Traditional Approach	With Aisle Containment	With Integrated CAC
	*Chiller	71.3%	64.9%	60%
	* Pumps	10%	5.4%	5.2%
	Air Handler Fan	18.7%	14.3%	7.2%
	Total	100%	84.6%	72.4%
	Savings		15%	28%

*Estimated savings based on dedicated datacenter chiller

Advantages of air containment with intelligent controllers

1. >30% increase in cooling system efficiency with dynamic load adaptation
2. >30% increase in IT equipment density. One can achieve IT equipment densities of 12 KW / rack with perimeter cooling and 30 KW / rack with localized cooling
3. With the integration between CAC and CRAC, an N+1 arrangement can work as a 2N, thereby increasing redundancy as a result of increased Cooling Capacity (the cooling capacity of CRAC increases with increased return air temperature)

4. Optimal utilization of space is achieved through CAC as the CRAC can be placed anywhere in the Datacenter.

As a result, a greater portion of the CRAC capacity can be utilized efficiently to achieve higher IT power densities.

Project details:

The facility is a R&D site of a leading electronic design company. The company shifted its nine numbers of server rooms in to a size Datacenter space. The old server rooms employed room cooling technique using 180 TR of cooling capacity for a total of 900 servers.

With the increase in design process, the new Datacenter consists of more than 1500 servers catering to the requirement. The Datacenter employs Cold air containment technique to avoid mixing of hot and cold air as depicted in the below figure.



Typical installation of cold air containment

Results of the project

The implementation of cold air containment had resulted in reduction of cooling requirement. The Datacenter cooling requirement has reduced from 180TR to 120TR even with the increase in Servers for 900 servers.

- The project would find replication in scenarios where conventional room cooling technique is implemented
- The project involves a major revamp of the cooling infrastructure, which requires external expertise. The project, being highly capital intensive, has to be taken up as part of a business decision

Case Study 8

INTRODUCTION OF SYSTEMATIC CABLE MANAGEMENT FOR BETTER AIR DISTRIBUTION IN RAISED FLOOR SYSTEM

Background:

In Datacenters with a raised floor, the sub floor is used as a plenum, or duct, to provide a path for the cool air to travel from the CRAC units to the vented floor (perforated tiles or floor grilles) tiles located at the front of the racks. This sub floor is often used to carry other services such as power, cooling pipes, network cabling, and in some cases water and/or fire detection & extinguishing systems.

During the design phase, the floor depth will be specified to deliver sufficient air to the vented tiles at the required flow rate. Subsequent addition of racks and servers will result in the installation of more power and network cabling. Often, when servers and racks are moved or replaced, the old cabling is abandoned beneath the floor. This is especially true for co-location and facilities with high levels of client turnover. If cabling is run beneath the floor, sufficient space must be provided to allow the airflow required for proper cooling. Ideally, sub floor cable trays should be at “upper level” beneath the floor to keep the lower space free for the cooling plenum.

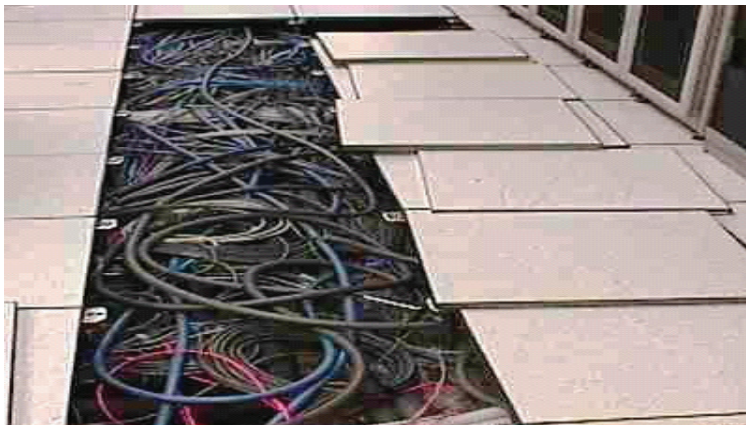

Cable problem in the raised floor Data Center

In many cases, the raised floor space has become a dumping ground for excess cables and cords. This clutter interferes with the ability of the cooling system to force cool air under the floor, through the perforated floor tiles, and over to the server intakes. The cooling system has to work harder to achieve the same cooling result and more energy is consumed to achieve the same task.

Many Datacenter professionals recognize the negative impact of the crowded floor. The biggest concern is the impact on uptime, which is most often influenced by human errors.

Possible solution:

When planning the flow path of cables, the first step would be to determine whether the cables will enter the enclosure from bottom or top. If entering from the top, the location of enclosure roof cutouts and their proximity to the vertical cable channels need to be considered. If entering from the bottom, consideration must be given to any obstruction in the base that can interfere with the cable entry path.

A greener solution would be to remove cable blockage and to migrate to overhead cable distribution if possible.



Layout of the overhead cable arrangement

In addition, block the unused raised floor cutouts to eliminate unwanted air leakage. Perforated tiles (with a design of about 25% open area) are used to ensure uniform and predictable airflow distribution in lower density areas of the Datacenter. In some cases where higher density racks are involved, the plenum may not be adequate to deliver the needed cubic feet per minute (CFM) through a 25% perforated tile.

The cooling system can be optimized by,

- Placing CRACs/CRAHs suction across hot aisles
- Installing the first tile for air supply at least 8 feet (2.4 meters) from CRAC/CRAH
- Running the data cables only under hot aisle area to minimize under floor airflow obstructions to cold aisle area

- The project would find replication in scenarios where the cooling is done through raised floor systems
- The project involves minor modification of the existing cooling system. The project does not require any capital investment. The project can be taken up by the in-house team during regular maintenance activity

In addition, air pressure sensors can be installed under the raised floor to lower the CRAC speed when a constant high pressure is not needed.

Case Study 9

BENEFITS OF HUMIDITY CONTROL FOR ENERGY EFFICIENCY IN DATACENTER

Background

Precision humidity control is essential to the effective operation of Datacenters, server rooms and other facilities housing sensitive electronics. Humidity control is typically provided by the precision air conditioning system, with the humidification system playing the central role in the process.

With ever-increasing requirements for reliability and availability, environmental control is critical for protecting today's sensitive computer systems. A clean, filtered environment with precise control over temperature and humidity is mandatory.

The optimal relative humidity range for a Datacenter environment is 45-50 percent. An above-normal level of moisture in the air can corrode switching circuitry, which can result in malfunctions and equipment failures. In data processing equipment, hygroscopic (moisture absorbing) circuit boards expand and contract with fluctuating humidity levels. Expansion and contraction of these boards can break microelectronic circuits and edge connectors. Also higher humidity levels increase the energy consumption in cooling system.

On the other hand, low humidity can cause static electricity that will interfere with normal equipment operation and potentially destroy electronic components should a static discharge occur.

Although a number of technologies have been developed to provide humidity in the Datacenter — evaporative, ultrasonic, immersion, infrared, steam canister and steam grid — steam canister and infrared are the most commonly used.

Infrared is the preferred choice for mission critical applications because it provides faster, more responsive operation than any other systems.

Infrared humidifier

Infrared humidifiers are the latest type of humidifiers which uses high intensity quartz infrared lamps over a stainless steel humidifier pan. The infrared radiation from the lamps breaks the surface tension of the water, allowing the air flowing across it to evaporate and carry the moisture away as a particle free vapor. This provides very precise and fast humidification.

Advantages of Infrared humidifier

- › Fast, responsive, energy-efficient humidification
- › Full capacity achieved in seconds

- › Water quality ($\mu\text{S}/\text{cm}$ & TDS) has negligible effect on performance and effectiveness
- › Automatic flush cycle helps remove mineral deposits
- › Easily cleanable stainless steel humidifier pan
- › Hi-water float switch
- › Lamps are not in contact with water

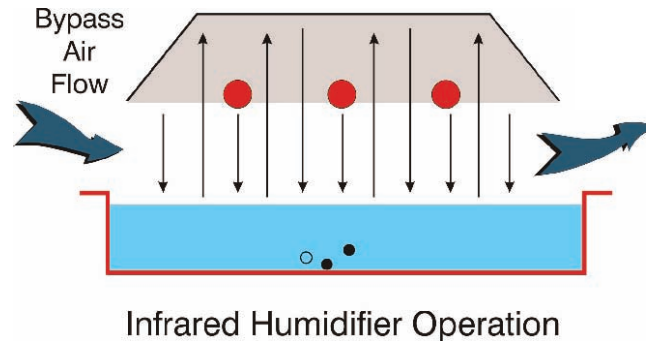

Figure 3.14: Infrared Humidifier Operation

Measures

The first step to avoid the continuous process of dehumidification and humidification is to reduce the superfluous dehumidification in the system. It can be done by raising the cooling coil apparatus dew point by adopting the following techniques:

- › Lowering the room dew point after verifying the requirements for environmental conditions of the equipment, by increasing the temperature and lowering relative humidity to the recommended level
- › Increasing the size of the cooling coil in CRAC/CRAH units to increase the average coil surface temperature. Although not a standard offering, it is possible to request for a DX CRAC unit with a mismatched compressor / coil pair. For example, a 20 ton compressor to be used with a 25 ton cooling coil. Increasing coil size is done at the design stage, and might increase the unit size and initial cost.
- › Adjusting controls for wider tolerance of “cut-in” and “cut-out” settings, allowing indoor humidity levels to swing by 10% RH or more. This is possible by adjusting the dead band setting in the CRAC units.
- › The savings from this measure come from reduced control overlap between adjacent CRAC units, i.e. the controls of one machine calling for humidification while the controls of the neighboring machine call for de-humidification.
- › Coordinating the unit controls of multiple independent CRAC units to act like a single large CRAC unit. The savings from this measure are similar to widening the control settings, which reduce the overlap of control between adjacent CRAC units.

Note: Depending upon IT hardware heat density, there will be different conditions at different CRAC units. Therefore the control of temperature at each CRAC unit should be appropriate.

- › Increasing air flow to raise average coil surface temperature and air temperature.

Note: This measure would increase fan energy consumption sharply and may exceed the savings achieved by controlling humidification.

The other sources of moisture loss come from envelope losses, especially in dry weather conditions. In wet conditions, this may be nil, or even reversed so as to be beneficial. Moisture losses from the envelope can be mitigated by reducing air pressure differences between adjacent spaces, vestibules, gasket doors, and an effective air barrier / vapor barrier on the floor, walls, plenums, and ceiling.

The project involves fine tuning in the existing cooling system. The project does not require any capital investment. The project can be taken up by the in-house maintenance team

Case Study 10

BENEFITS OF REDEFINING INLET CONDITIONS FOR ENERGY EFFICIENCY IN DATACENTER

Background

Critical cooling systems consume 35% to 45% of the overall Energy in Datacenters. The CRAC unit is one of the major energy consumers. Therefore minimizing power consumption by the CRAC units leads to significant energy savings in Datacenters.

There are many reasons for high power consumption in Datacenters. One of the reasons is the operating temperature. In many cases, Datacenters operate at temperatures that are much lower than required by the IT equipment. In CRAC units, lower supply temperatures result in higher energy consumption.

The reasons for lower operating temperatures in Datacenters are:

- ▶ Maintaining the return air set point less than 25°C. Since the PACs are controlled based on return air temperature, the supply temperature to the IT equipment would be much lower than the required
- ▶ To achieve a longer ride-through time during a cooling outage. For example, if the maximum allowable server temperature is 95° F (35° C), operating the room at 68° F (20° C) will offer a little extra time over operating the room at 70° F (21° C) in the event of a cooling failure
- ▶ The room is being kept colder to achieve marginal inlet temperatures in worst-case locations. The majority of Datacenters have areas with poor airflow dynamics which experience higher temperatures for a subset of their equipment. Any attempt to raise operating temperatures would need to consider these areas into account. A variety of actions can be taken to lessen the risk to these areas, such as moving tiles to re-balance air-flows, moving IT systems to cooler areas, implementing supplemental cooling for specific hot spots, and establishing containment strategies for cold or hot aisles to ensure appropriate airflow segregation
- ▶ The room temperature is based on personnel comfort level. Obviously personnel comfort will have to be weighed against the opportunities for energy savings. Some of the more aggressive efforts to operate at high temperatures have been accompanied by the provision of separate air-conditioned spaces adjacent to the Datacenter for personnel, as well as service strategies that limit the amount of time spent in the Datacenter. Perforated tiles have also been used temporarily in a hot-aisle work area during maintenance activities.

Method for inlet condition optimization

The lower inlet air temperature is based on the concept that higher inlet air temperature leads to higher component temperatures which will affect the reliability. However, an increase in inlet temperature does not necessarily mean an increase in component temperatures. The component temperature can

be maintained constant irrespective of the inlet conditions by varying the air flow rate

Consider the following graphs showing a typical component temperature relative to an increasing ambient temperature for an IT system with constant speed fans and varying speed fans.

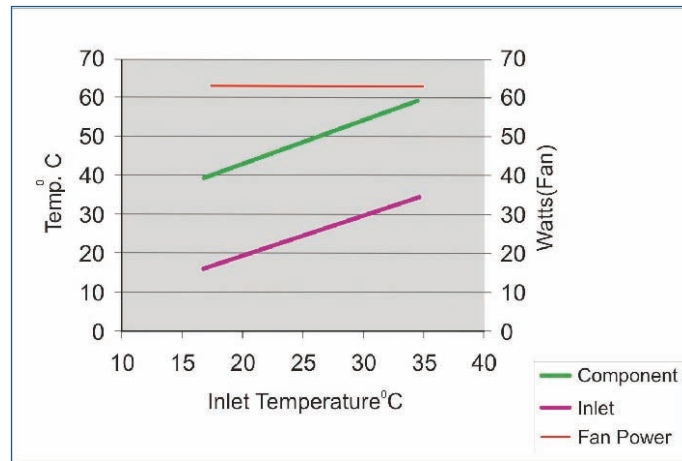

Figure 3.15: Inlet and Component Temperatures with fixed fan speed relative to increasing ambient temperature

In constant speed fans, the component temperature tracks the inlet temperature and rises along with inlet temperature. In this case the fan power consumption does not vary. The component temperature is regulated by inlet conditions. Therefore inlet condition is maintained on lower side which increases the energy consumption.

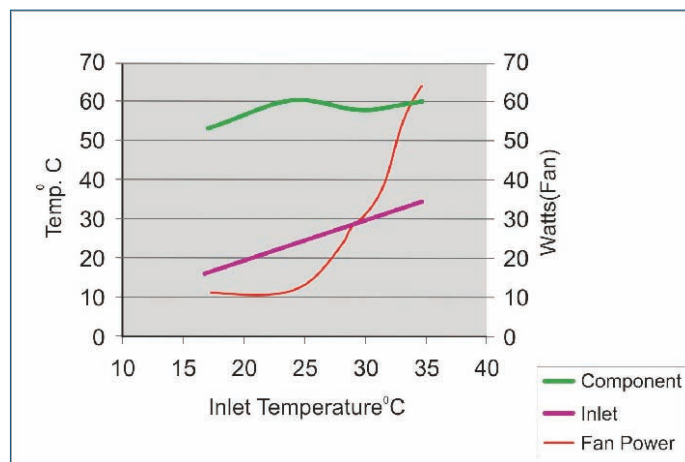

Figure 3.16: Inlet and Component Temperatures with variable fan speed relative to increasing ambient temperature

Now consider the response of a typical component in a system with variable speed fan control. The component temperature is maintained at average temperature in the entire range of inlet conditions by varying the fan speed.

Variable speed fans decrease the fan flow rate at lower temperatures. Fan speed control optimizes the reduction in fan power to the point that component temperatures are still within vendor temperature specifications i.e. the fans are slowed to the point that the component temperature is constant over a wide range of inlet air temperatures.

This particular system has a constant fan flow up to approximately 23 °C. Below this inlet air temperature, the component temperature tracks closely to the ambient air temperature. Above this inlet temperature, the fan adjusts flow rate such that the component temperature is maintained at a relatively constant temperature.

A higher operational temperature should be a consideration in the search for increased Datacenter efficiency. Coupled with PAC energy-saving options, an increase in operating temperatures offers the opportunity of saving large amount of energy - 5% or more at the facility level is possible.

The recommended environmental envelope for IT Equipment is the 2004 referenced ASHRAE Datacom. These recommended conditions as well as the allowable conditions refer to the inlet air entering the datacom equipment. Specifically, it lists for Datacenters in ASHRAE classes 1 and 2, a recommended environment range of 20°C to 25°C (68 to 77 °F) Dry Bulb Temperature and a Relative Humidity (RH) range of 40% to 55%.

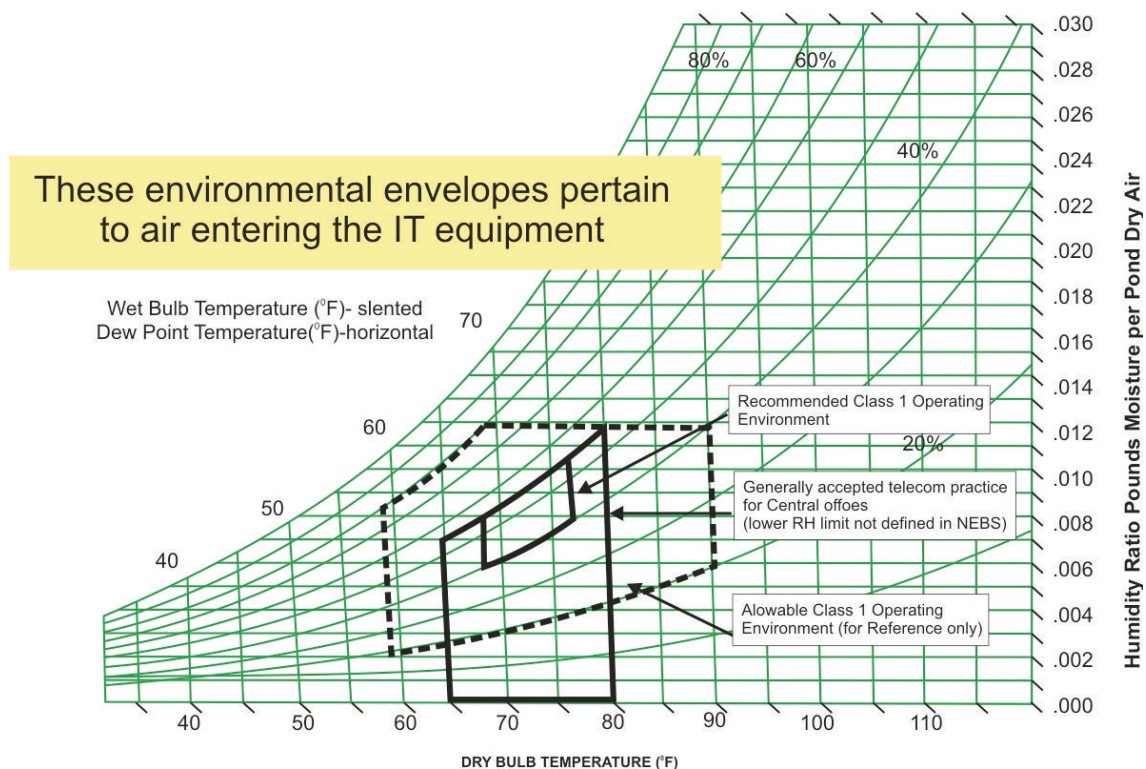

Figure 3.17: Dry Bulb temperature (vs) Humidity ratio

To provide greater flexibility in facility operations, particularly with the goal of reduced energy consumption in Datacenters, TC 9.9 has undergone an effort to revisit these recommended Equipment

Environmental Specifications, specifically the recommended envelope for classes 1 and 2. The result of this effort is to expand the recommended operating environment envelope.

The purpose of the recommended envelope is to give

- › Guidance to Datacenter operators on maintaining high reliability
- › Operate their Datacenters in the most energy efficient manner.

In reviewing the recommendation, the 2008 expanded operating envelope is acceptable to all the IT manufacturers, and operation within this envelope will not compromise overall reliability of the IT equipment. The previous and 2008 recommended envelope data is shown in table below:

Table 3.5: Recommended environment envelope data

Parameter	2004 Version	2008 Version
Low End Temperature	20°C (68 °F)	18°C (64.4 °F)
High End Temperature	25°C (77 °F)	27°C (80.6 °F)
Low End Moisture	40% RH	5.5°C DP (41.9 °F)
High End Moisture	55% RH	60% RH & 15°C DP (59 °F DP)

The 2008 recommended environmental envelope is shown in red in the figure below:

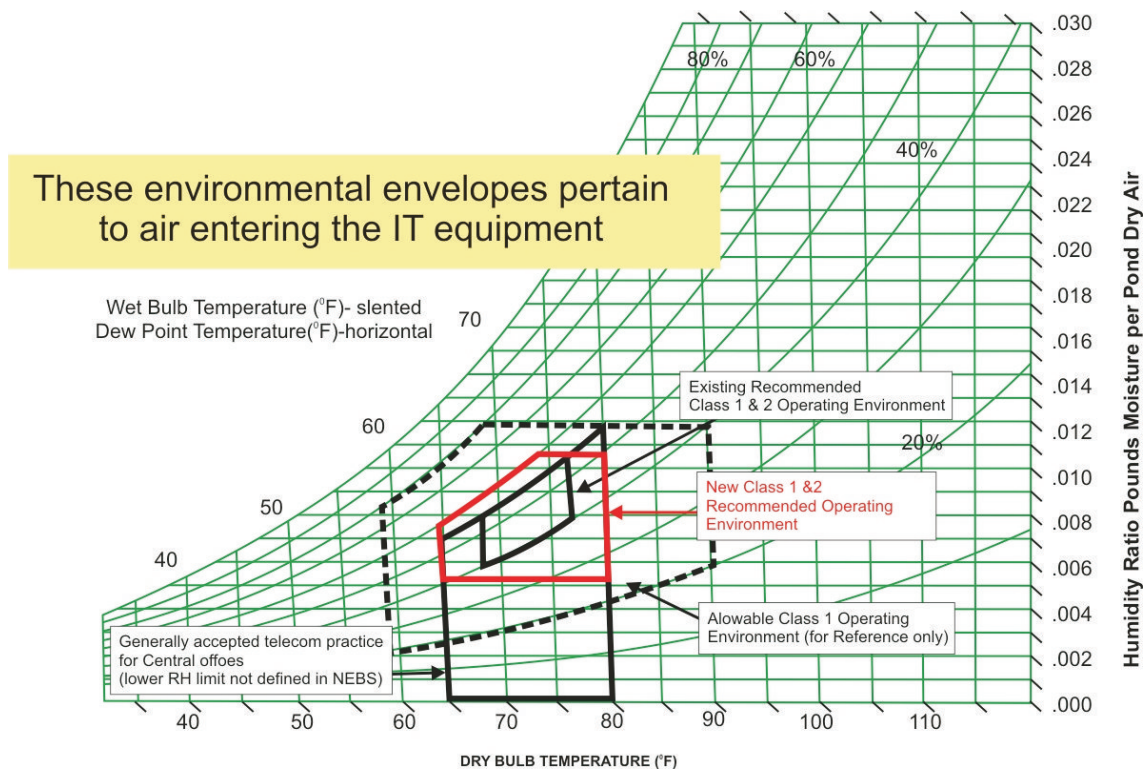

Figure 3.18: Recommended environment envelope data

Depending on the cooling system design and outdoor environmental conditions there will be varying degrees of efficiency within the recommended zone. The ranges included apply to the inlets of all equipment in the Datacenter (except where IT manufacturers specify other ranges). Attention is needed to make sure the appropriate inlet conditions are achieved for the top portion of IT equipment racks.

Benefits:

- › The project would find replication in Datacenters where the inlet temperatures are maintained on a higher side
- › The project involves fine tuning in existing cooling system. The project does not require any capital investment.

Case Study 11

BENEFITS OF WATER COOLED CABINETS IN COOLING SYSTEM

Background

The dynamic growth in the number of projects led to an unplanned demand for additional computing capacity at one of the older Datacenters of an IT firm.

There was a great need to install new servers to support rapid growth in design computing needs. Installation of new servers in the existing space would result in increased server density which increases the heat load in the Datacenter. The Datacenter has difficulty due to lack of cooling capacity to handle the increased heat load.

The difficulty was addressed by installing 26 water-cooled cabinets to contain 2184 servers. This had doubled the capacity of the existing room while adding only 600 kW to the total power load. Each cabinet contained about 84 blades with the power load of 23kW/cabinet.

Project

To overcome the problem of ever increasing load of the Datacenter one of leading manufacturer in precision cooling decided to take up a project of building design a cooling unit with a closed architecture.

With taking into consideration of raising the energy costs it decided to manufacture a rack built cooling unit. The sealed cabinets used the facility's existing chilled water supply to cool the air that re-circulated within the cabinets to cool the servers. It was observed that the cabinets effectively cooled all servers even under full load condition.

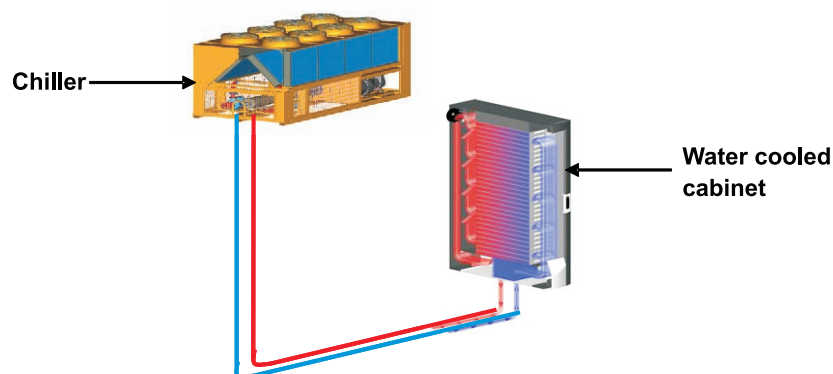

Figure 3.19 : Water Cooled Cabinet

Advantages of closed server cabinet

- › Maximum energy efficiency
- › Minimal air circulation
- › Short air flow path
- › Highest delta T / air return temperature
- › Highest coolant feed / return temperature
- › No dehumidification

After observing the satisfactory operation, the water-cooled cabinet systems were installed in a 5000 sqft server room. Chilled water was supplied to the cabinets using pipes beneath the raised floor. The room already contained about 2000 servers in conventional air-cooled racks, but there was enough space to accommodate additional cabinets.

Totally 26 water-cooled cabinets were installed. Each cabinet contained 6 blade chassis with up to 14 blades per chassis for a total of up to 84 blades per cabinet. This created an average load of approximately 21 kW per cabinet. Additional 2184 servers were added in water-cooled cabinets. This increased the total number of servers in the room to more than 4000, which is double the previous number of servers.

The sealed, water-cooled cabinets produced very little external heat up to 1 kW per cabinet. Therefore, their effect on the room's ambient air temperature was found to be negligible. However, the cabinets placed an increased load on the Datacenter chilled water system, requiring the installation of additional chillers and piping.

Benefits of the project

Using water-cooled cabinets, which provide highly power-efficient cooling, it was able to quickly add server capacity in the existing space to support business requirement. Water cooled cabinets can be useful for increasing capacity of older Datacenters.

- › Useful for high density cooling solutions
- › Removes heat at source and reduces load on CRAC units
- › Modular and flexible system that can be expanded
- › Flexible hose connectors and under floor manifold allows reconfiguration of racks in the future
- › Increased compute power capacity up to 8X compared to air cooled facilities
- › Can be retrofitted for existing installation

Constraints

- › Water-cooled cabinets are more expensive than air-cooled cabinets
- › They introduce complexity, requiring additional monitoring

Case Study 12

OPERATE IT EQUIPMENT COOLING SYSTEM AT A HIGHER TEMPERATURE DIFFERENCE

Background

The heat load in the Datacenter is on constantly on the rise. Thermal management is often overburdened with trying to effectively removing the heat load. However, structural conditions often mean that a change over to a water-cooling system implementation cannot be immediate.

Thermal management equipment is often working at its full capacity, and consequently consume enormous amount of energy.

Project

One of the leading manufacturers of the precision cooling units came up with cost effective option to constantly separate the cold air zone from the warm air zone.

The cold air containment ensures that the cold air flowing through the raised floor is channeled through the cabinets. As a result the all installed servers are provided with consistent cold air over the entire height of the cabinet.

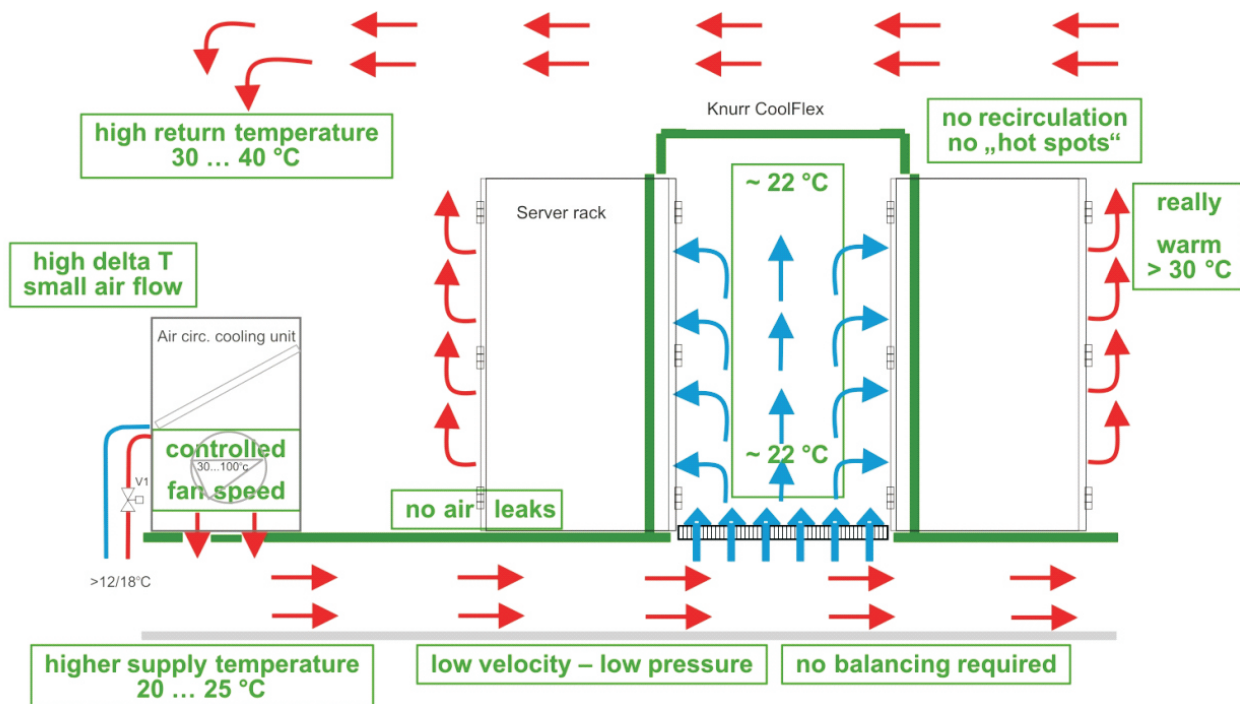

Figure 3.20: Typical arrangement of cold aisle containment

The containment reduces usual heat mixing on the Datacenter ceiling without effect on the cold aisle, and the hot air short cuts are no longer possible. This significantly improves cooling efficiency, resulting in reduction of cold air required. This in turn means that energy cost also fall considerably.

This containment produces a consistent temperature over the entire height of the cold aisle. This significantly facilitated in increased air speed intake temperatures (20°C- 25°C).

This provides an advantage for both operator and environment, lower energy cost for driving fans in the CRAC equipment, suitable air intake for the servers and more pleasant working conditions.

The higher intake air temperature allows inflow water temperature to decrease, which results in further saving.

Another advantage of a higher equipment delta-T is a higher return temperature at the CRAC making the units to operate closer to the rated cooling capacity, to reduce number of CRAC units needed to cool the same load and, in turn, less energy required for fans in the CRACs.

The warmer the air passing through the cooling coil, the less likely the entire coil surface area will experience a temperature below the dew point. If more of the coil surface is positioned above the dew point, possibility of condensation is decreased. Thus energy wastage is avoided, which otherwise occurs in both the condensation and the humidification process.

Benefits

Maintaining higher temperature difference across the IT equipment would increase the air temperature to the cooling coil. Thus reducing the condensation, in turn reduces the cooling load requirement.

Case Study 13

CFD SIMULATION FOR ENHANCED DATACENTER PRODUCTIVITY

Background

High power dissipation from microprocessors, support chips, memory chips and mass storage has resulted in large overall power dissipation from computer systems. The deployment of these computer systems in large numbers and in very dense configurations in a Datacenter has resulted in very high power densities at room level. These computer systems are deployed in a rack

Simulation Can Help Improve Reliability Visualization of airflow patterns and temperature distribution and can help answer questions regarding

- › Plenum airflow patterns
- › Room airflow patterns
- › Rack inlet temperatures
- › Static pressure distribution
- › Tile airflow distribution
- › Short-circuiting of airflow or re-circulation from rack outlets to rack inlets
- › Effects of equipment and layout changes
- › Effects of various failure scenarios

The various ways in which simulation can be done are:

- › PAC Performance Analysis
- › Floor Grill Analysis
- › Rack Analysis

PAC performance analysis:

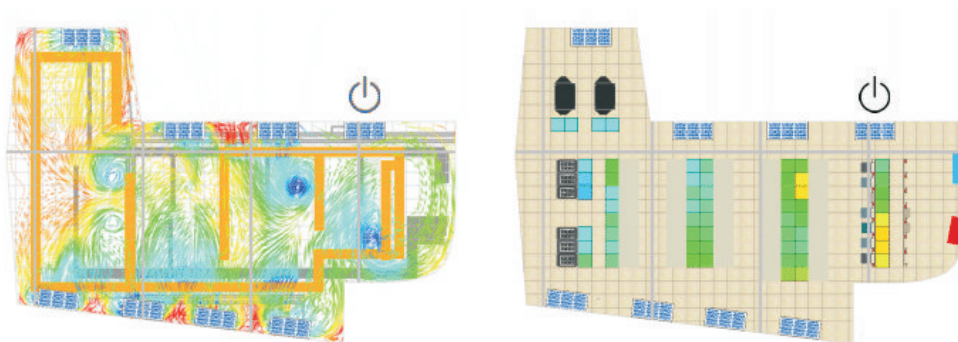

Figure 3.21: PAC performance analysis

Floor grill analysis:

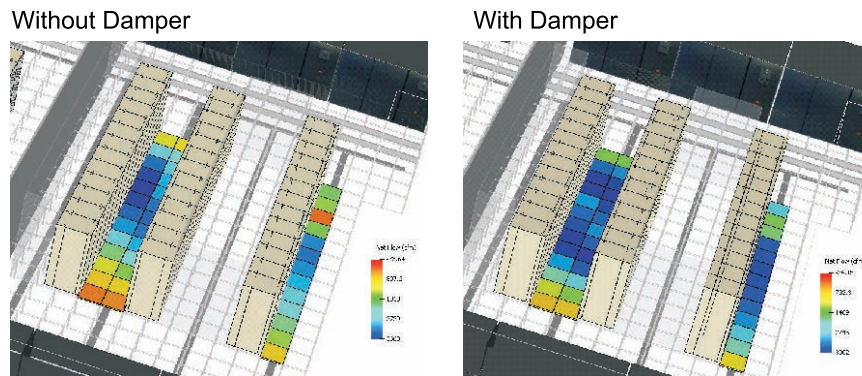

Figure 3.22: Floor Grill analysis

Rack analysis

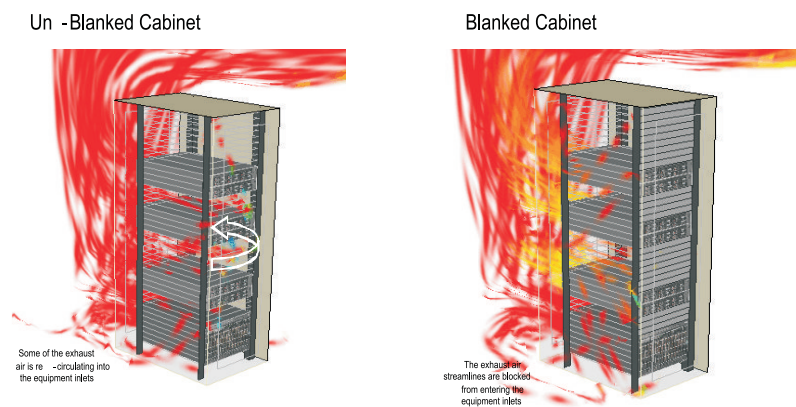

Figure 3.23: Rack analysis

Conclusion:

- ▶ Using CFD simulation, Facility Managers, IT Professionals, Designers, and Engineers can answer the question of whether or not the thermal environment for the equipment in their Datacenter (existing or future) is acceptable
- ▶ If conditions are unacceptable, then information about airflow patterns and temperature distributions in their Datacenter can be used by them to modify Datacenter layout (rack locations, tile locations) and possibly adjust cooling equipment specifications/requirements
- ▶ Process of simulation, evaluation, and Datacenter modification can be used to help ensure the reliability of the Datacenter

Benefits

- ▶ CFDs help in simulating an environment which will enable the Datacenter operators to test the proposed Datacenter in various conditions
- ▶ The CFD analysis requires external expertise

Case study 14

THERMAL STORAGE SYSTEM FOR EMERGENCY COOLING REQUIREMENTS

Background

A power sag or complete outage can cause the cooling system to temporarily shut down. In Datacenters with high power and heat densities, a power outage can cause rapid increase in temperature. This is due to the servers continuing to produce heat, as they are supplied power through the UPS, while the cooling system is temporarily non-functional. The rapid increase in temperature may cause severe damage to IT equipment. Calculations show that if cooling is interrupted, a high density Datacenter may only take 18 sec to reach 40° C and only 35 sec to reach 57° C.

This necessitated the implementation of low cost thermal storage system that maintained cooling at a high density Datacenter during an electrical power outage. The system enables the Datacenter to operate even during the power outage without affecting the IT process. The system has an auxiliary thermal storage tank that fed water into the chilled water supply lines if the main chillers stopped working due to a power outage.

There are several methods for increasing the flexibility of Datacenter cooling systems to power disturbances. Some Datacenters, requiring high availability, use standby generators for chillers. However, these will significantly add to the Datacenter cost. Also, generators take several seconds to start up, after which it takes several minutes more to restart the chillers. These delays may be acceptable in low-density Datacenters, because temperature increases slowly, but in high-density Datacenters, even a few seconds' delay can cause problems due to rapid temperature rise.

Thermal storage methods were found to offer an alternative, providing varying degrees of flexibility of responses to power failures, at much lower cost, and with less complexity. Thermal storage can extend the ability to cool Datacenter IT equipment in the event of a power failure by using thermal reserves to provide temporary cooling during a power outage.

Operation of thermal storage system

During normal operation, the centrifugal chillers supply chilled water at 13° C to the CRAHs that cool the IT equipment. Meanwhile, the low temperature scroll chillers maintain a trickle of cold water supply to the thermal storage tanks, which keeps the tanks at about 6° C. Storing water at this temperature reduces the cost and size of the thermal storage tanks. Also, in the event of a power outage, the cold water from the tanks passes through the system for a longer time before it becomes too hot.

During normal operation, the thermal storage tank valves are closed, isolating the 6° C water in the tanks from the main 13° C chilled water system.

In the event of power outage, the centrifugal chillers stop. The thermal storage tank valves open and add the water kept at 6° C to the main 13° C supply feeder line, helping to keep the main chiller water supply at the required temperature limit.

Project details

A thermal storage system has been installed at the Datacenter facility of a leading company. The facility uses both centrifugal and scroll chillers. The three 1200 TR centrifugal chillers, which are more efficient in terms of kW/TR, supply the main cooling system with chilled water at 13° C. This is used for sensible cooling of the areas housing IT equipment and power supplies. There are two small 175 TR scroll chillers to supply a smaller capacity system with chilled water at 6° C. This is used for latent cooling and non-critical loads. The 6° C system also cools the water in the thermal reserve tanks.

During a utility power outage, the chiller plant shuts down and takes several minutes to resume normal cooling. The UPS continues to power the IT equipment in the Datacenter, which therefore continue producing heat. Under such conditions, the servers in the Datacenter will suffer thermal damage and shut down due to a high ambient temperature. Sometimes it may damage the servers and incur a potentially huge cost for server replacement.

The solution was to install a large supplemental thermal reserve system. The system was based on two 100 m³ cold water tanks. The tanks were sized to provide enough capacity to cool the Datacenter for 7 minutes longer than the UPS battery life.

The chilled water pumps were on a separate facility. Therefore, they kept the cold water moving through CRAH cooling coils. The CRAH fans were also on the UPS, so they continued to move air through the cooling coils and deliver cold air to the Datacenter space.

Benefits of the project

The Thermal storage system enabled cooling operations to continue uninterrupted so as to facilitate continuous IT process operations even during power outages.

- The thermal storage system would find replication in scenarios where the IT process involves mission critical applications
- The project involves major revamp of the cooling infrastructure, which requires external expertise. The project, being highly capital intensive, has to be taken up as part of a business decision

Chapter 4

IT Equipment and Peripherals



Summary Note
on

'DATA CENTRE IT EQUIPMENTS AND PERIPHERALS'

Every datacenter has to respond to changes in density, capacity and availability created by new technologies and changing business conditions. There is also an continuously growing need for greater operating flexibility, higher system availability and lower operating costs. On top of all this energy efficiency has emerged as one of top concerns for datacenters given the rising cost and scarcity of energy. Therefore, it is essential to enhance the efficiency by choosing high-efficiency equipment by design but this is often overlooked due to its high initial cost. However, considering Total Cost of Ownership (TCO) provides a better way of focusing on high efficiency designs. The options available to data center designers are very varied. Choice of designs and equipment should be based on a careful analysis of current needs and projected growth based on strong awareness of the advantages and disadvantages of each choice.

This initiative of CII under the guidance of BEE involving experts from the domain is an effort to capture and thereby enable a higher degree of awareness about maximizing energy efficiency of Data Centers through guidelines and key best practices documentation

This chapter on 'Data Centre IT Equipments & Peripherals' highlights some key points that help in designing high efficiency datacenters like enterprise consolidation, network virtualization, effective storage utilization, infrastructure efficiency improvement through virtualization etc.

I am extremely thankful to all members of this Group for their immense contribution towards the successful completion of this Chapter. I would also like to appreciate how the members managed to find time out of their busy schedules to attend the meetings and complete their deliverables.

Last but the not the least, I would like to express my sincere thanks to Mr. Suprotim Ganguly and Mr. D. Manikandan of CII for gathering experts from the domain and continuously driving the effort forward through very effective co-ordination and organization of meetings and tracking of deadlines.



Chandrashekhar Appanna
Chairman, Core Group on 'IT Equipments & Peripherals' &
Distinguished Engineer, Cisco Systems Pvt Ltd

LIST OF MEMBERS ON IT EQUIPMENT & PERIPHERALS (CORE GROUP - 3)

SI No	Name	Organization
1	Mr Chandrashekhar Appanna	Cisco Systems India Pvt. Ltd.
2	Mr Anil Nileshwar	Cisco Systems India Pvt. Ltd.
3	Mr K. Arun Bhat	Intel Technology India Pvt. Ltd
4	Mr. Abhish Kulkarni	Hewlett Packard India Sales Pvt. Ltd.
5	Mr Brahma Reddy	Ctrl S Datacenters Ltd.
6	Dr Bhubhaneshwari	Indian Institute of Technology, Delhi
7	Mr Girish S Jagajampi	IBM India Pvt. Ltd.
8	Mr Kiran kumar	Ctrl S Datacenters Ltd
9	Mr Kartik Ramarao	Sun Microsystems India Pvt Ltd
10	Mr Ravi Giri	Intel Technology India Pvt. Ltd
11	Mr Radhakrishna	Infosys Technologies Ltd.
12	Mr Rishi Mehta	Tata Communications Ltd.
13	Mr Sandeep Wattal	IBM India Pvt. Ltd.
14	Mr Sringsesh B S	Wipro Infotech
15	Mr Sudeep Palanna	Texas Instruments (India) Pvt. Ltd.
16	Mr Sudhir Nair	Infosys Technologies Ltd.

4.1 Introduction to server technology

A computer or electronic device serving out application or services can technically be called as Server. A Server is a combination of hardware configured with specific program that delivers services to its clients. Generally, server and client programs run on different computers which transfer or exchange data over a communication network.

Due to power and space constraints, IT infrastructure encounters difficulty with the use of traditional low density servers

Traditionally, low power density servers using single core micro-architecture processors were used in Datacenter application. As demand for the service grow, the requirement for operation of number of servers increased. In response to such demand, the server market has witnessed noticeable transition in the server technology.



Figure 4.1: Server Rack

For the reasons, such as power and space constraint, IT infrastructure encounters difficulty with the use of traditional low density servers.

The advancement in the server technology introduced consolidation of multiple single core architecture servers into a single multi-core architecture referred as server blades. A blade server is a high-density server, typically used in a clustering of servers that are dedicated to a single/multi task. Like most clustering applications, blade servers can also be managed to include load balancing and failover capabilities. Each blade typically comes with one or two local ATA or SCSI Hard drives. For additional storage, blade servers can connect to a storage pool facilitated by a Network-Attached Storage (NAS), Fiber Channel, or iSCSI Storage-Area Network (SAN). The advantage of blade servers comes not only from the consolidation benefits of housing several servers in a single chassis, but also from the consolidation of associated resources like storage and networking equipment into a smaller architecture that can be managed through a single interface.

Servers are usually housed in operational/server rooms and physical access to them is restricted for security reasons. They are often rack-mounted for convenience.

A server rack is a metal enclosure used in Datacenters and server rooms to securely house all IT equipments. In addition to servers, other IT networking and storage equipment is also mounted in these racks. Racks are referred as server racks, network enclosures, data racks, etc.

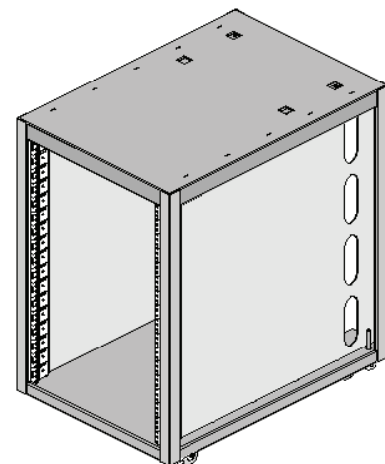

Figure 4.2: Rack Enclosure

4.2 Server power consumption

Table 4.1: Server power consumption breakup (Source: USEPA report)

Component	Peak Power (Watts)
CPU	80
Memory	36
Disks	12
Peripheral slots	50
Motherboard	25
Fan	10
PSU losses	38
Total	251

Servers are operated with DC voltage, but utilities deliver AC power and at higher voltages than required by the computers. The conversion requires one or more power distribution units (PDUs). To ensure uninterrupted service, even entry-level servers are supplied with redundant power supply sources. Table 4.1 shows the typical breakup of power consumption in a server.

Any saving in IT load would have a direct impact on the loading of most of the support systems such as Critical Cooling, Uninterruptible Power supply, and Power Distribution Units thereby affecting the overall energy performance of the Datacenter positively

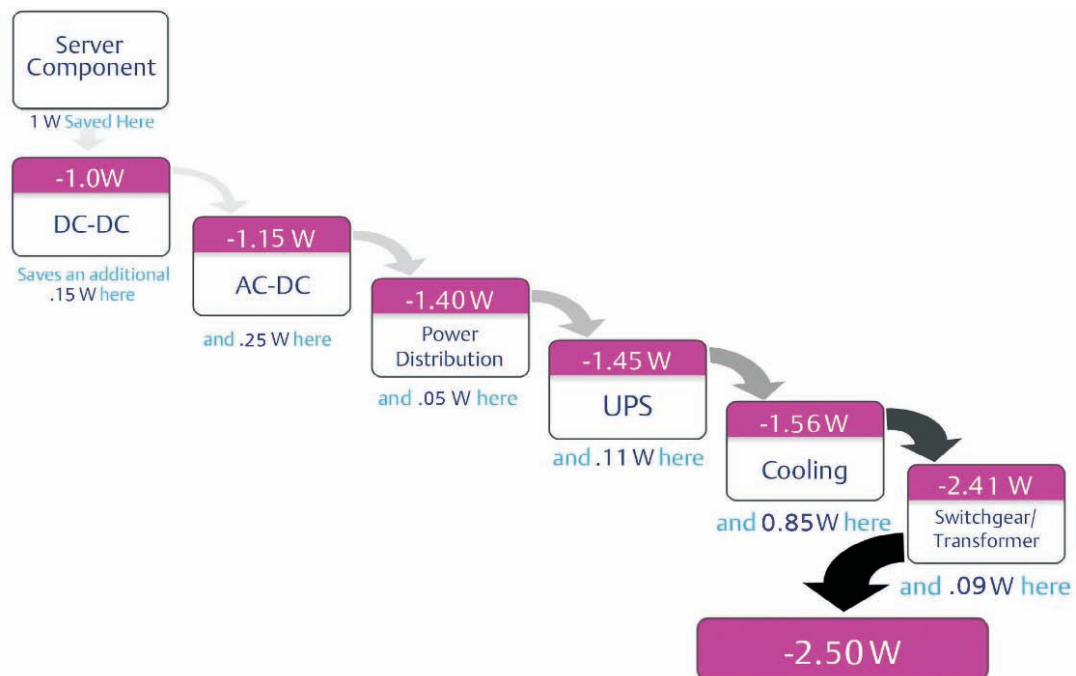

Figure 4.3: An estimated saving through “Cascading Effect”

Studies show that 1 Watt saved at the server component level results in cumulative savings of about 2.84 Watts in total consumption, through cascade effect as shown in Figure 4.3. This flow of events is known as the Cascade Effect.

4.3 Challenges in Critical Cooling

IT equipment in a Datacenter generates a significant amount of heat. The heat has to be removed properly to ensure the performance of the IT equipment. This is achieved by passing cold air through the server from the front and exhausting hot air at the rear end of the server.

Advancements in server technology and the increase in the demand for higher computational capacity have strongly challenged the traditional air-conditioning system of a Datacenter. As the computational power increases, the power consumption of the servers also increases. It is evident from the fact that the rack power density had increased from 2kW/rack to

35-40kW/rack, creating hot zones in the Datacenter space. Therefore cooling system is often stretched to ensure proper cooling in all hot zones.

Latest cooling techniques adopt spot or supplemental cooling and In row cooling techniques to address the hot zones in a Datacenter.

4.4 Strategies for reducing Datacenter energy consumption

A leading critical space management company cites the following 10 methods to minimize Datacenter energy consumption. Let us consider a case of a 5000 sq. ft. Datacenter having 120 W/Sq. ft. loading to calculate the savings.

The table 4.2 shows the statistical data of savings for the case considered on account of implementing various energy saving techniques.

Table 4.2: statistical data of savings

	Strategy	Initial datacenter	Optimized datacenter	Saving (KW)	%	
1	Low power processor	91W/processor (Average)	70W/processor	111	10%	30%
2	High-efficiency power supplies	AC-DC →79% DC-DC →85%	AC-DC →90% DC-DC →88%	124	11%	
3	Server power management	Power consumption 80% of full load when idle	45% of full load when idle	86	8%	
4	Blade servers	All rackmount	20% blades	7	1%	
5	Server virtualization	No virtualization	20% servers virtualized	86	8%	11%
6	Power distribution architecture	208V AC	415V AC provides 240V single phase	20	2%	
7	Implement cooling best practices	Hot aisle/Cold aisle	Optimized cold aisle and chilled water temperature, no mixing of hot and cold air	15	1%	
8	Variable-capacity cooling	Fixed capacity cooling	Variable capacity refrigeration and airflow	49	4%	11%
9	High-density supplemental cooling	Floormount cooling only	Floormount plus supplemental cooling	72	6%	
10	Monitoring and optimization	No coordination between cooling units	Cooling units work as a team	15	1%	
		Initial datacenter load: 1,127 kW	Total savings	585 kW	50%+	

Source : Emerson Network Power

The strategies are discussed below in detail:

4.4.1. Thermal Design Power (TDP)

Thermal Design Power (TDP) serves as an alternate comparison for server power consumption. The typical TDP of processors in use today is between 80 and 103 Watts (91W average). The processors that consume, on average, 30 Watts less than standard processors are available in the market today. Independent research studies show that these low-power processors deliver the same performance as higher power models.

In the 5,000-square-foot Datacenter considered, low-power processors create a 10 percent reduction in overall Datacenter power consumption.

Presently, the processor manufacturers provide lower voltage versions of the processors which consume less power as shown in the table 4.3.

Table 4.3: Typical power consumption of servers

	Sockets	Speed (GHz)	Standard	Low power	Saving
AMD	1	1.8-2.6	103W	65W	38W
	2	1.8-2.6	95W	68W	27W
Intel	2	1.8-2.6	80W	50W	30W

Intel, AMD and other manufacturers offer a variety of low-power processors that deliver average savings between 27W and 38W

4.4.2. Power Supplies Efficiency Optimization

The estimated average efficiency of installed server power supplies in a conventional Datacenter is 79 percent across a mix of servers that range from four-year-old to new.

Best-in-class power supplies available today deliver an efficiency of 90%. It has been estimated that the use of these power supplies may reduce power drawn within the Datacenter by 11 percent on the total load of 1.13 MW.

As with other Datacenter systems, server power supply efficiency varies depending on load. Some power supplies perform better at partial loads than others. This is particularly an important factor to consider in dual-corded devices where power supply utilization can average less than 30 percent. The figure 4.4 shows power supply efficiencies at different loads for two power supply models. At 20 percent load, model A has efficiency of approximately 88 percent while model B has efficiency closer to 82 percent.

The project involves fine tuning in the existing cooling system. The project does not require any capital investment. The project can be taken up by the in-house maintenance team

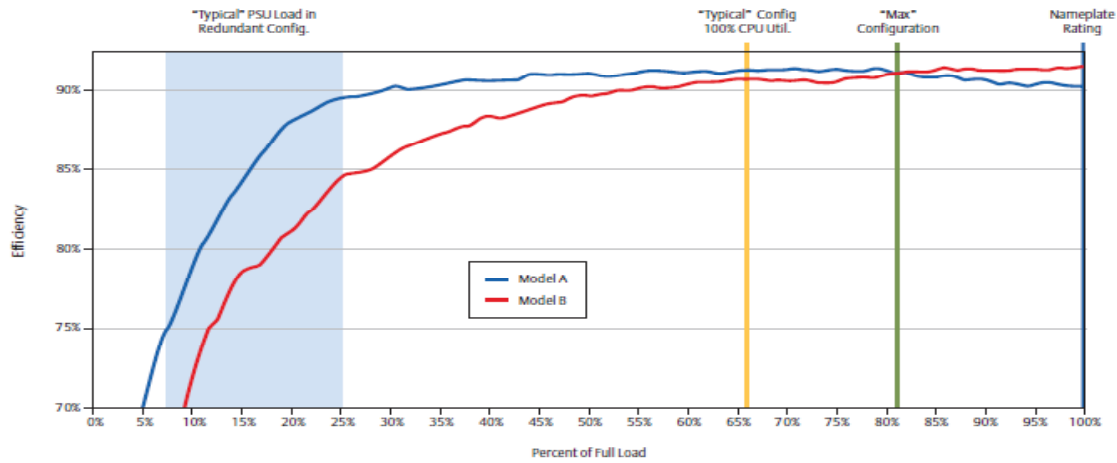

Figure 9. Power supply efficiency can vary significantly depending on load, and power supplies are often sized for a load that exceeds the maximum server configuration.

Figure 4.4: Percent of full load (vs) Efficiency of Power Supply

The figure 4.4 also highlights an opportunity to increase efficiency by sizing power supplies closer to actual load. Notice that the maximum configuration is about 80 percent of the nameplate rating and the typical configuration is 67 percent of the nameplate rating.

4.4.3. Utilizing Server Power Management Software (SPMS)

Datacenters are sized for peak conditions that may rarely exist. In a typical business Datacenter, daily demand progressively increases from about 5 a.m. to 11 a.m. and begins to drop at 5 p.m.

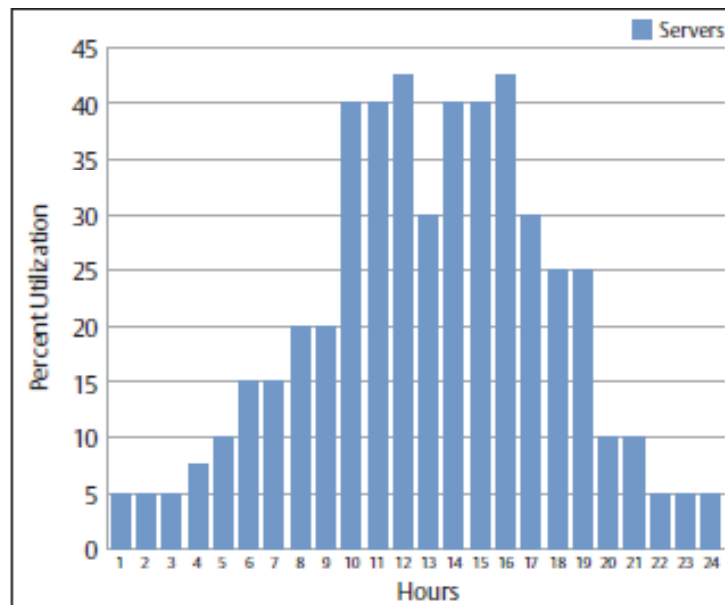

Figure 4.5: Time (vs) Percent utilization of server

Server power consumption remains relatively high as server load decreases. It is reported that in the idle mode, most of the servers consume almost 70 to 85 percent of full operational power.

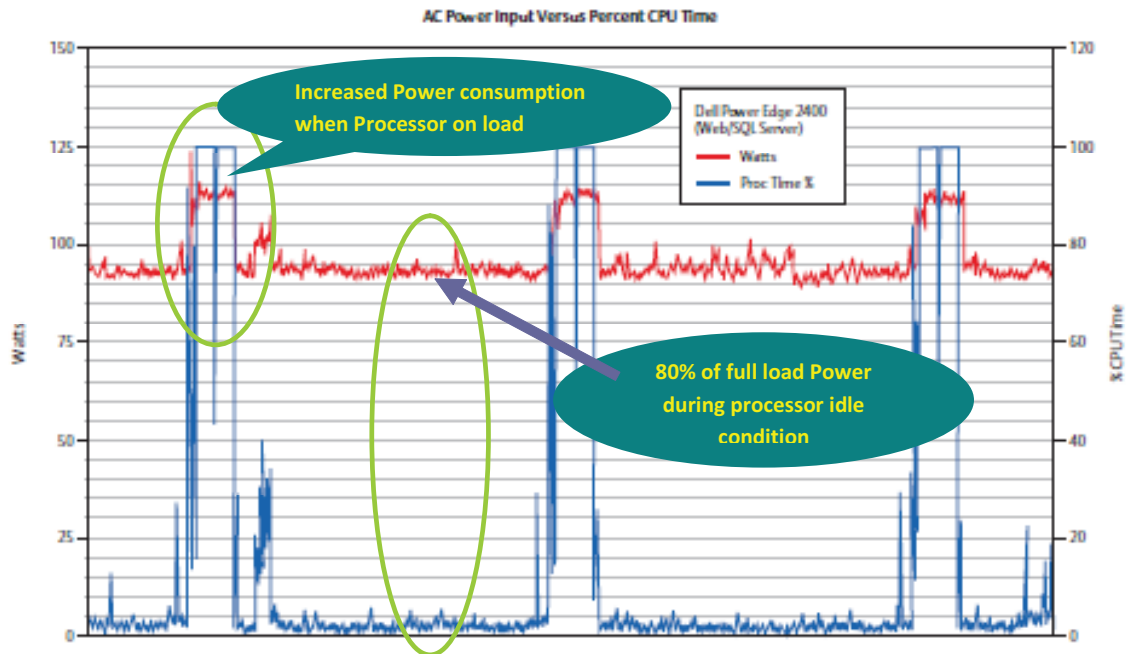

Figure 4.6: AC input power (vs) percent UPS time

Consequently, a facility operating at just 20 percent capacity may use 80 percent of the energy that the same facility uses when operating at 100 percent capacity. Server processors have power management features built-in that can reduce power when the processor is idle. Too often these features are disabled because of concerns regarding response time; however, this decision may need to be re-evaluated in the light of the significant savings that using this technology can bring about with sacrificing the performance level.

Server processors have built-in power management features that can reduce power during processor idle condition

With the power management enabled, the idle power drawn reduces by 35% of the peak power.

In the given case, power management can save 8 percent of the overall Datacenter load.

4.4.4. High Density Server Blades (HDSB)

Blade servers are servers with a modular design used to minimize the number of conventional servers and the physical space required to house them. A server blade is a complete server (processor, system memory, network connection, and associated electronics, etc.) on a single motherboard. The motherboard slides into a Blade enclosure. The enclosure can contain multiple no of Blades as shown in Figure 4.7.

Blade servers are suitable for specific purposes such as web hosting and cluster computing. Blades are considered to be hot-swappable, which means one can add new blades or remove existing ones while the system is powered.

Many organizations have implemented blade servers to meet processing requirements and improve server management. While the move to blade servers is typically not driven by energy considerations, blade servers can play a role in energy conservation.



Figure 4.7: Blade server

Blade servers consume about 10 percent less power than equivalent rack mount servers, because multiple servers share common power supplies, cooling fans and other components. More importantly, blades facilitate the move to a high-density Datacenter architecture, which can significantly reduce energy consumption.

“High density architecture using Blade servers at least consume 10 percent less power than conventional servers for the same computational capacity”

4.4.5. Server Virtualization

Virtualization is being used to increase server utilization and reduce the number of servers required. It has been estimated and reported that 8:1 virtualization may reduce the initial power consumption by 12 to 20 percent.



4.4.6. Changing Power Distribution Architecture

The power distribution system represents another opportunity to reduce energy consumption; however care must be taken to ensure the availability.

Many Datacenters use Double-Conversion type UPS. These systems convert incoming power to DC and then back to AC within the UPS. This enables the UPS to generate a clean, consistent waveform for IT equipment and also effectively isolates IT equipment from the power source. UPS systems that don't convert the incoming power known as Line Interactive or passive standby systems, may operate at higher efficiencies. This is because they do not undertake the high-loss conversion process. However, these systems may compromise equipment protection because they do not fully condition incoming power.

A bigger opportunity exists downstream from the UPS. In most of the Datacenters, the UPS delivers power to the server at 208V. If the voltage can be raised to 240V, the power supplies in the servers will operate at increased efficiency. Servers and other IT equipment can handle 240V AC inputs without any negative consequences. Depending on the way the power distribution is designed to deliver this higher AC voltage, energy savings can be as high as 2 percent of the total energy consumption with the cascade effect and up to 3 percent taken in isolation.

4.4.7. Air management through Computational Fluid Dynamics (CFD) analysis

Many Datacenters have implemented hot-aisle/ cold aisle rack arrangement. Further potential for increasing the cooling efficiency exists by sealing the gaps in floors, using blanking panels in open spaces in racks, and avoiding the mixing of hot and cold air. The Computational Fluid Dynamics (CFD) can be used to study the airflow pattern and suitable measures can be taken to optimize the air flow to improve the cooling system efficiency. Many organizations offer CFD study as part of Datacenter IT performance assessment services focusing on cooling system efficiency improvement. CFD study as part of Datacenter assessment services focusing on cooling system efficiency improvement.

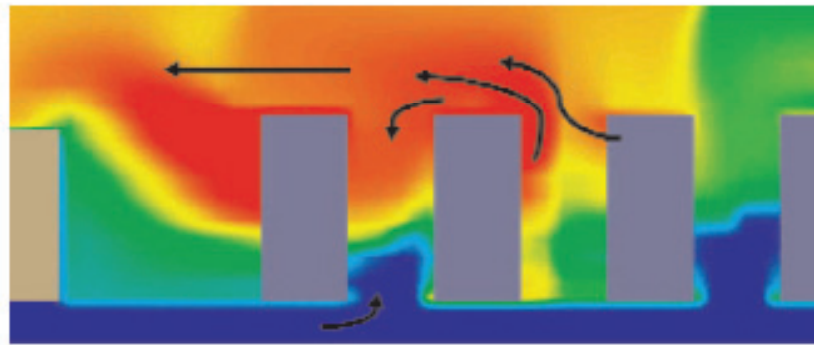

Figure 4.8: CFD Analysis

Additionally, optimizing the temperatures in the cold aisle may be a viable possibility to optimize the cooling power consumption. When the required temperatures are above 68°F, the chilled water temperature can be raised up to 50°F. In the case discussed, cooling system efficiency was improved by 5 percent by adoption of these practices, improving energy efficiency by 1% without any cost.

CFD analysis helps to study the air flow pattern which facilitate to formulate suitable measures to improve the cooling system efficiency

When the required air temperatures is above 68°F, optimization of chilled water temperature from 45°F to 50°F has additional energy saving to the tune of 2-3% in overall energy consumption

4.4.8. Variable-capacity cooling

Datacenter IT systems are sized to handle peak computational load which is a rare condition and therefore the heat generation rate also changes. Consequently, indicated efficiency of the cooling system at full load is often not the actual operating efficiency. Operating efficiency would highly deviate from the design efficiency based on the loading.

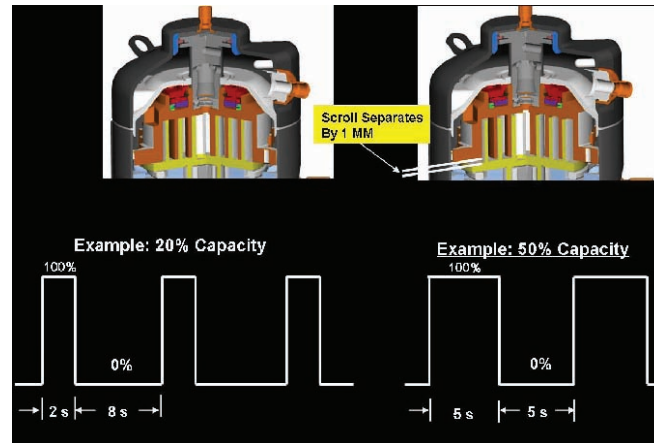

Figure 4.9: Scroll Compressors

Latest technologies, such as Digital Scroll compressors and variable frequency drives in computer room air conditioners (CRACs), maintains better operating efficiencies even at partial load conditions. A digital scroll compressor dynamically regulates the capacity of air-conditioners to match the room conditions without turning the compressors on and off.

Typically, CRAC fans run at a constant speed and deliver a constant volume of air flow. Converting these fans to variable frequency drive fans allows fan-speed and power to be reduced as load decreases. Fan power draw is directly proportional to the cube of fan rpm and 20 percent reduction in fan speed provides almost 50 percent of savings in fan power consumption. These drives are available in retrofit kits that make it easy to upgrade existing CRACs, with a payback period of less than one year as reported.

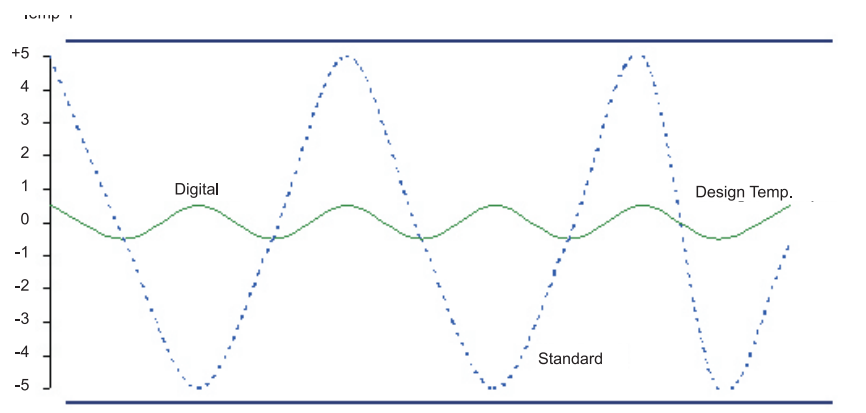

Figure 4.10: Temperature variation using Standard and digital scroll compressor

It is also an established fact that in the chilled- water based air-conditioning system, the use of variable frequency drives might save 4 percent of the initial power consumption.

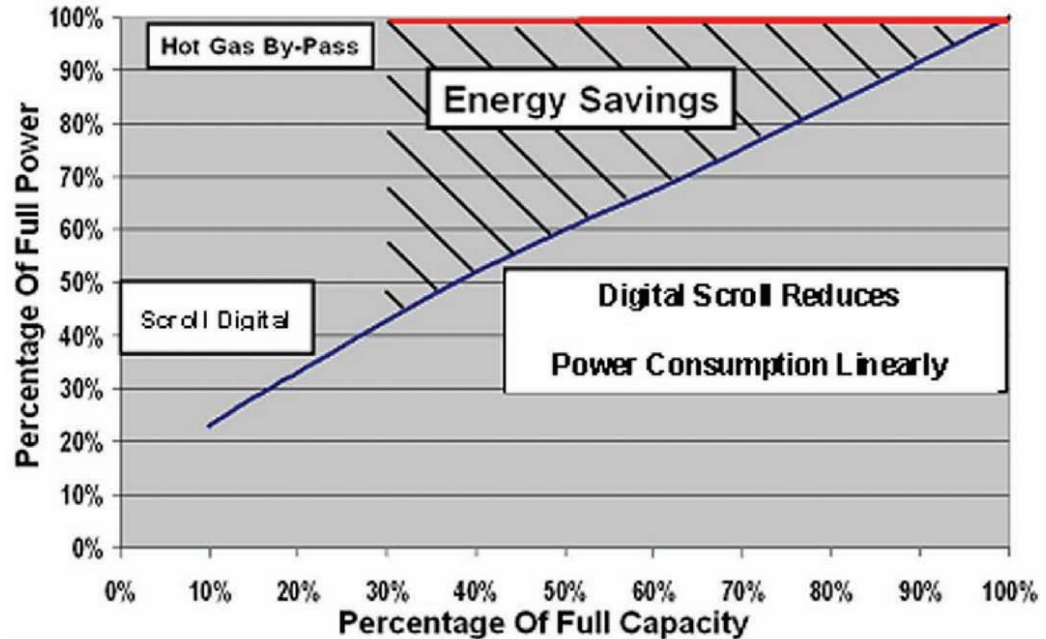

Figure 4.11: Percentage of full capacity (vs) Percentage of full power

4.4.9. High-density supplemental cooling

Traditional room-cooling systems have proved very effective at maintaining a safe, controlled environment for IT equipment. However, optimizing Datacenter energy efficiency requires change from traditional Datacenter densities (2 to 3 kW per rack) to an environment that can support much higher densities (in excess of 30 kW). This requires implementing a cooling system that shifts some of the cooling load from traditional CRAC units to supplemental cooling units.

Supplemental cooling units are mounted above or alongside of the equipment racks. They pull hot air directly from the hot aisle and deliver cold air to the cold aisle. Supplemental cooling units can reduce cooling costs by 30 percent. The savings are achieved by reduction in fan power consumption by bringing the cooling action closer to the source of heat. It also uses more efficient heat exchangers to remove sensible heat from the dry

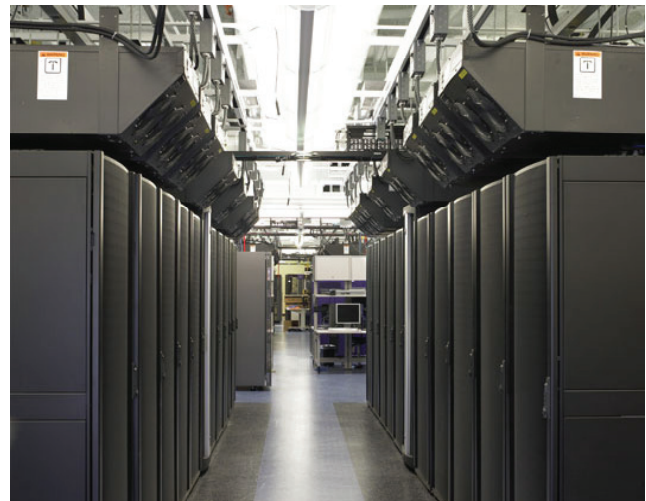

Figure 4.12a : Installation of high density supplemental cooling

hot air generated by electronic equipment. The refrigerant is delivered to the supplemental cooling modules through an overhead piping system. The overhead piping system provides more flexibility and allows cooling modules to be easily added or relocated as the environment changes.

A typical example of 20 racks at 12 kW density (Figure 4.12a) per rack use high-density supplemental cooling while the remaining 40 racks (at 3.2 kW density) are supported by the traditional room cooling system. This creates an incremental 6 percent reduction in overall Datacenter energy costs.

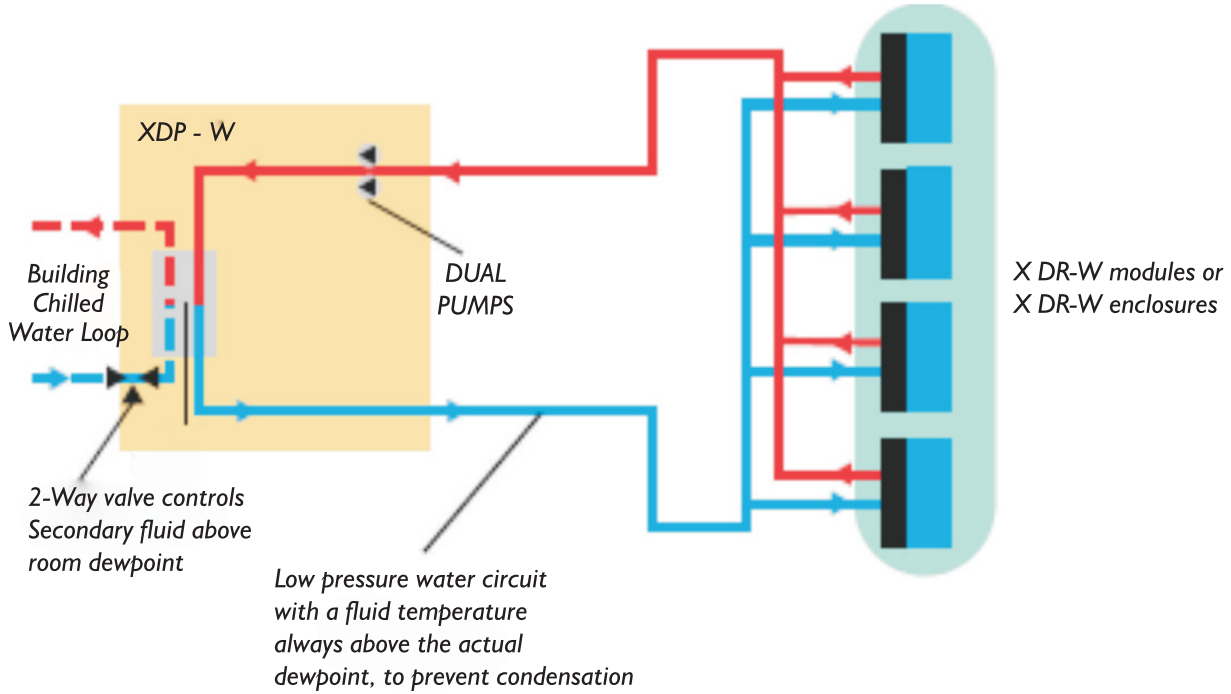

Figure 4.12b: Schematic of supplemental cooling

4.4.10. Monitoring and Optimization

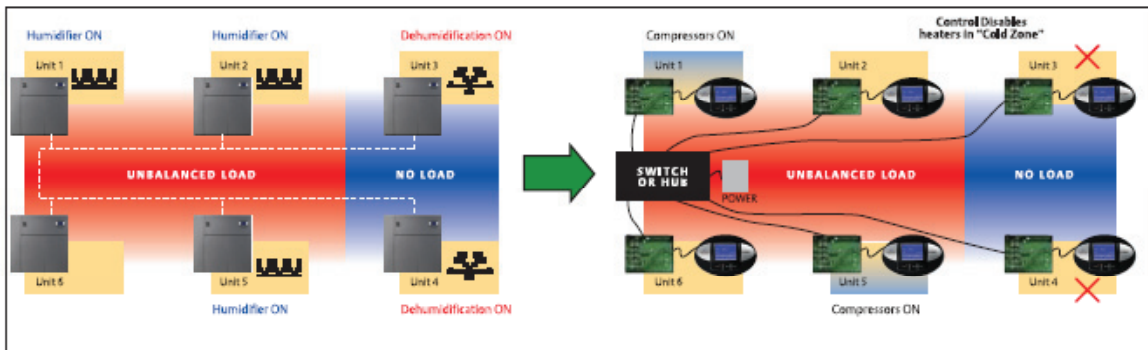

Figure 4.13: Schematic of CRAC unit with intelligent controller

One of the consequences of rising equipment density has been increased diversity within

the Datacenter. Rack densities are rarely uniform across a facility and create hot zones in a datacenter. Therefore, overall cooling system would operate in high cooling mode to maintain adequate cooling in hot zones, which creates inefficiency in cooling system.

The implementation of adequate monitoring and proper optimization would suffice to minimize the cooling system inefficiencies

4.5 Energy conservation tips for IT equipment

This section briefly discusses various energy saving possibilities in IT and IT Peripheral systems. The following energy saving techniques are supported by the case studies given later in this chapter. The following energy saving techniques are supported by the case studies given later in this chapter.

4.5.1 Monitoring the utilization of servers, storage, and network devices

IT devices are designed based on the prediction of resource requirement in the present as well as in the near future.

The capacity utilization of IT devices depends on the diversity factor, which is based on its operation. Since the devices consume almost constant power at all conditions, IT systems are under-utilized which leads to poor operational efficiency.

Continuous monitoring of utilization rates would facilitate Datacenter personnel with sufficient data to plan necessary action for optimizing the performance of IT devices.

4.5.2 Server consolidation

Datacenters consist of various types of servers based on application. The utilization rate of the servers depends on the criticality of their operation or mission of the Datacenter. A low utilization rate of servers results in poor energy performance.

The performance of a Datacenter can be improved by server consolidation & virtualization technology combined with capacity fine-tuning of utilities (HVAC and power).

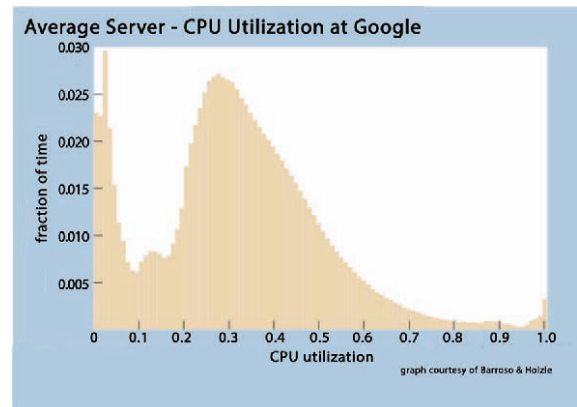

Figure 4.14: CPU utilization (vs) fraction of time

The key causes of poor energy performance in Datacenters are:

- Utilization of servers at a fraction of their processing capability
- Over-sizing the data storage system and its infrequent access
- Low data transfer rates in communication network

Virtualization technology improves Datacenter performance through the integration of multiple servers into a single high density server. High-density server uses shared resources to support its operation. Typically it halves the space requirements and reduces the cable requirement to one-eighth of the actual requirement.

4.5.3 Updating Network Storage System (NAS or SAN)

The storage disk drives in servers consume a significant percentage of the total energy used in servers. The standard practice is to continuously monitor the utilization rate of the disk drives.

Use of virtualization includes server consolidation in which many physical servers are consolidated into fewer servers hosting virtual machines. The physical server is therefore "transformed" into a virtual machine guest residing on a virtual machine host system. This is also known as Physical-to-Virtual or "P2V" transformation.

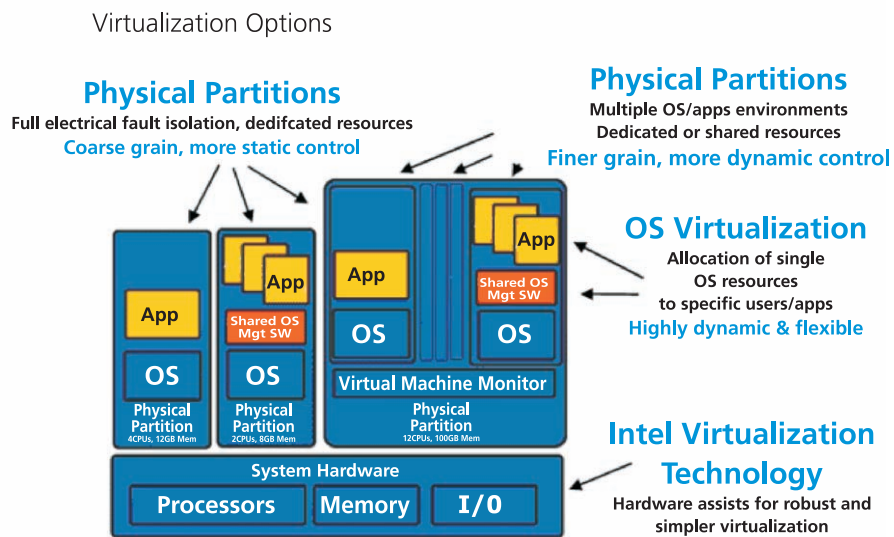
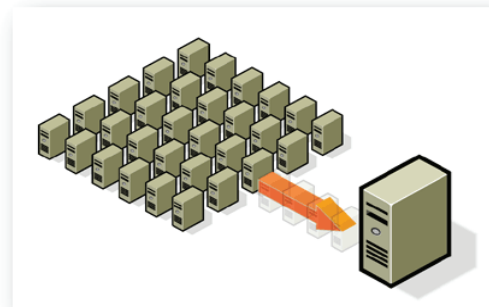

Source : Intel, 2007

Figure 4.15: Virtualization options

These drives may have a low utilization rate based on the mission and application. The utilization rate for storage varies highly for certain applications like engineering services, laboratory services, etc.

Nevertheless, the storage disk drives consume almost constant power irrespective of task performed. Therefore intermittent use or low utilization rate affects the overall energy performance of the storage system.

Storage Area Networks

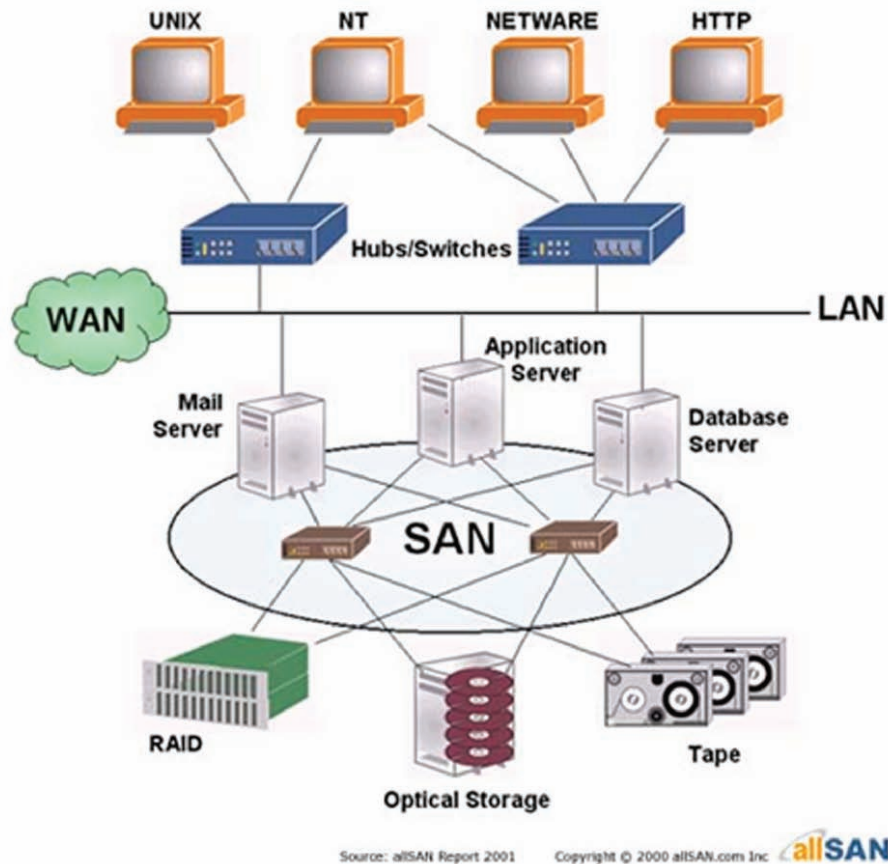

Figure 4.16: Schematic of Storage Area Networks

Consolidation of on-board disk drives to a network-attached (NAS or SAN) data storage device is an effective energy performance improvement technique which allocates and dynamically uses required storage space from the network of storage systems.

Apart from the performance improvement opportunities, the system provides flexibility for centralized data backup which can be accessed from various physical locations through network tunnels. This would minimize the operational cost on data backup infrastructure in a large organization.



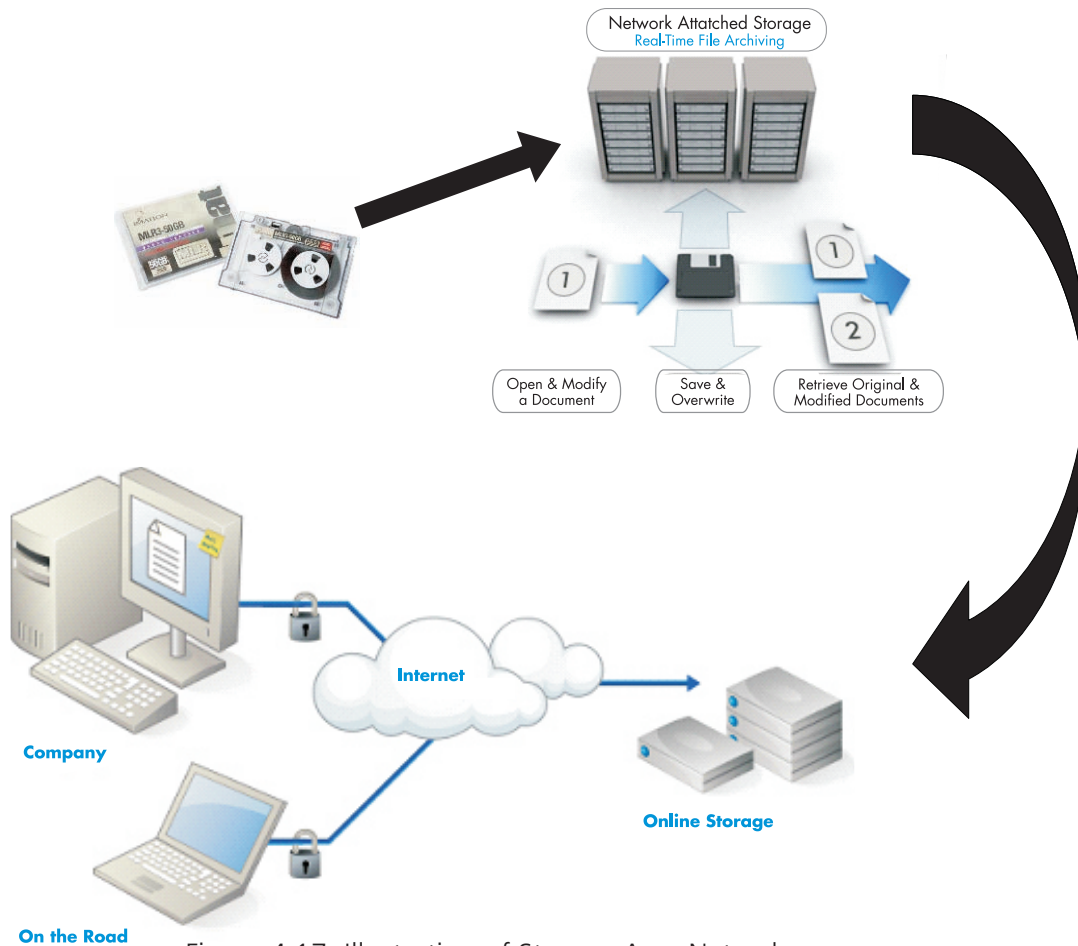

Figure 4.17: Illustration of Storage Area Networks

4.5.4 Allocating active storage for critical data handling

It is common to allocate more storage than actually needed to process the tasks. It results in infrequent access of storage resulting in poor energy performance, since the storage devices consumes energy even in idle condition.

Allocation of active data storage systems only for critical data, and moving less critical/sensitive data to higher capacity passive media offers good possibilities for energy conservation.

4.5.5 Computing performance metrics for new IT equipment

Performance metrics that utilize computational performance, to define the energy performance of IT equipment, is an important tool in the selection of IT equipment.

The metric allows the comparison of overall computing efficiency and will account for concerns such as processor efficiency, hardware/software compatibility, memory efficiency, etc.

For example, SPEC (Standard Performance Evaluation Corporation) benchmark SPECjbb 2005 is one such performance comparison metric for servers. The metric compares the servers based on Business Operations Per Second (BOPS) per watt of energy consumed.

The typical comparison chart for few servers is shown in chart.

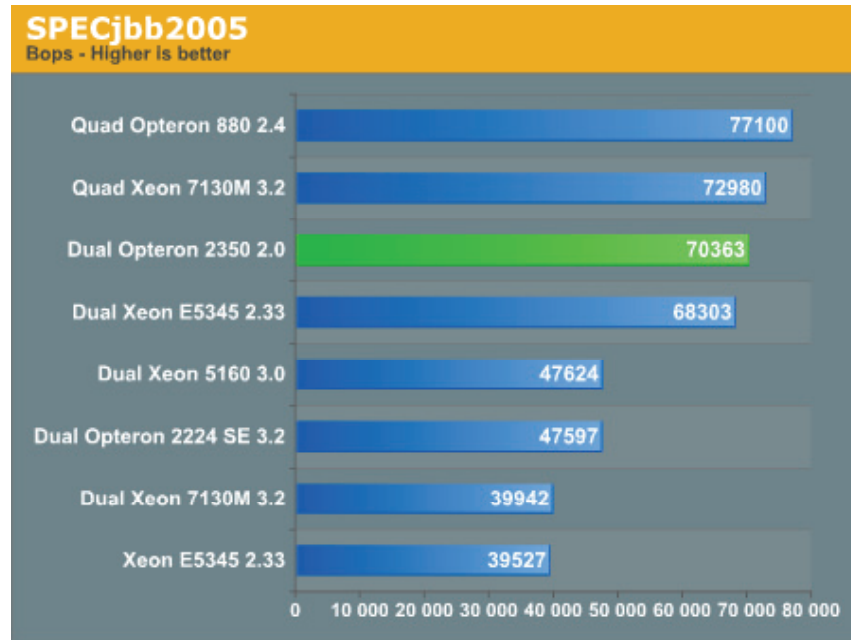

Source : SPECjbb2005

Figure 4.18: Performance comparison of different processors

SPECjbb2005 (Java Server Benchmark) is SPEC's benchmark for evaluating the performance of server side Java. Like its predecessor, SPECjbb2000, SPECjbb2005 evaluates the performance of server side Java by emulating a three-tier client/server system (with emphasis on the middle tier). The benchmark exercises the implementations of the JVM (Java Virtual Machine),

JIT (Just-In-Time) compiler, garbage collection, threads and some aspects of the operating system. It also measures the performance of CPUs, caches, memory hierarchy and the scalability of shared memory processors (SMPs). SPECjbb2005 provides a new enhanced workload, implemented in a more object-oriented manner to reflect how real-world applications are designed and introduces new features such as XML processing and Big Decimal computations to make the benchmark a more realistic reflection of today's applications.

SPECjbb2005 Benchmark Highlights

- › Emulates a 3-tier system, the most common type of server-side Java application today.
- › Business logic and object manipulation, the work of the middle tier, predominate.
- › Clients are replaced by driver threads, database storage by binary trees of objects.
- › Increasing amounts of workload are applied, providing a graphical view of scalability.

The architecture schematic of the SPEC jbb2005 benchmark process is given below:

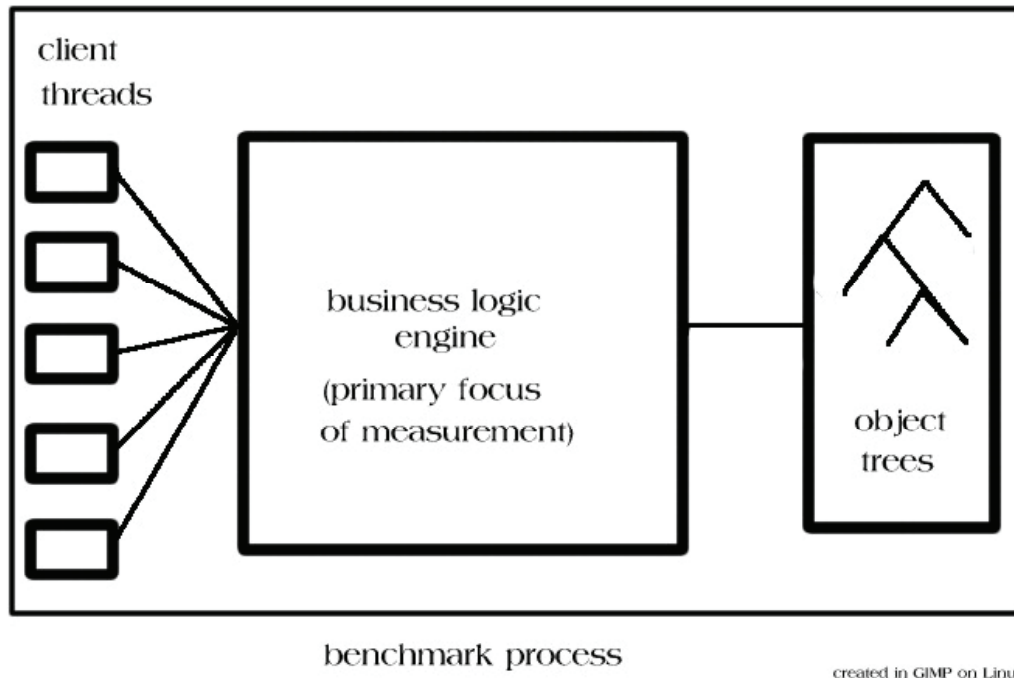

Figure 4.19: Benchmark Process

4.5.6 Virtualization of Network Devices

Network virtualization technologies enable increased utilization of network resources and exert more control over allocation of resources, adding more operational flexibility and scalability of resources.

It also reduces the cost and complexity of managing network infrastructure by reducing the number of physical devices in the network.

Case of Study 15

BENEFITS OF ACCELERATED SERVER REFRESH STRATEGY

The project involves design computing server refresh strategy that takes advantage of increasing server performance and energy efficiency to reduce the operational cost of Datacenters.

Same performance delivered for 90% less power and space

Background

The Server is one of the primary elements of a Datacenter. It provides specified service to the clients connected to it. The power consumption of a server is largely determined by its computational capacity of its processor.

Advancements in processor architecture have improved the computational performance to higher levels. The performance of servers has improved drastically with the introduction of "Multiple Core" architecture based processors. These processors support parallel processing and multi-threading techniques, thus enabling the simultaneous processing of multiple programs resulting in high density computational systems.

The use of high density computational servers enables consolidation of conventional servers and reduces the consumption of resources such as power, space, power supply units, and the cooling system.

The consolidation ratio is based on processor performance and the type of application being processed. The latest servers have a high consolidation ratio thus reducing the need for an expansion of facilities and avoiding construction costs even for increased computational capacity requirements.

Benefits of the project

- › Reduction of 850-890 kWh in energy Consumption by consolidation of every 500 older servers using blade server
- › Same performance delivered for 90% less power and space
- › Improved performance increases the productivity in design environment

Project details

The case is an initiative of a leading semiconductor design company which has increasing complex design computing requirements. The number of design computing servers had increased from 1000 in 1996 to 68000 in 2007. With the increasing computational requirements, the company faced the challenge of accommodating additional number of servers within the existing space, cooling and power infrastructure.

It becomes extremely expensive to build a new Datacenter and also to maintain and operate the growing population of conventional low-efficiency servers.

To tackle this problem, the company initiated an enterprise-wide Datacenter energy management program to explore the alternative server refresh strategy that takes advantage of increased server performance which optimizes the infrastructure usage and reduces the operational costs.

The company performed an extensive analysis to determine the benefits of accelerated server refreshes. The company analyzed the ROI that could be obtained by adopting different refresh cadences, ranging from one to six years. For example, with a six-year cadence, the company had consolidated and replaced all design servers more than six years old.

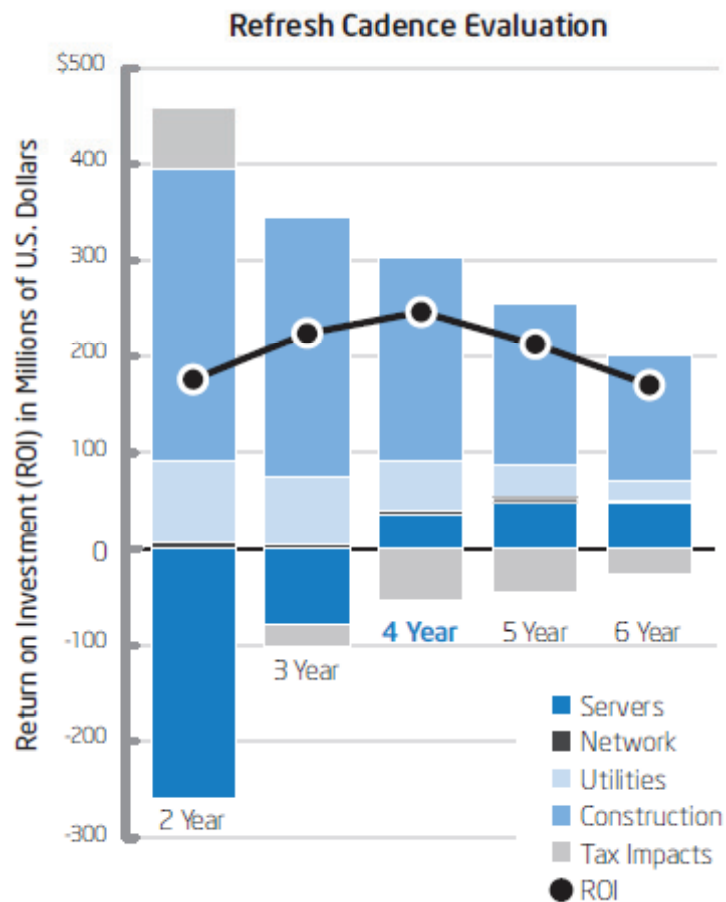

Figure 4.20: Refresh Cadence evaluation

The analysis estimated total costs over eight years with an assumption that the cost of each new server would remain stable over this evaluation period and the computing requirements would continue to increase at 15 percent per year. The analysis also accounted for region-wise cost variation in construction and utilities. Software cost was not included as it had already been considered as part of their broader Datacenter efficiency program.

The company found that a four-year refresh cycle delivered the highest ROI.

Results of the project

Based on the high consolidation ratios that can be achieved in batch computing platform in a design environment, the estimated reduction in energy consumption was approximately 850-890 kWh by consolidation of 500 old servers using blade servers.

The program projected an increase in computational capacity for same the space and utilities. The performance of the new servers also boosted productivity across the design services.



With the four-year refresh cycle program, the company saved nearly Rs 12500 million due to the best combination of construction avoidance, and utilities savings after accounting for server refresh costs

Case Study 16

ENTERPRISE COMPUTING PERFORMANCE IMPROVEMENT THROUGH CONSOLIDATION OF DATACENTERS

The project demonstrates the adoption of high density computing equipment for consolidation of Datacenters at various sites, thereby improving the computational performance of an enterprise.

Background

The case is the success story of a leading technology developer who supplies technology solutions to critical business market. The company owns many laboratories and facilities for its R&D services and production. The laboratories have exclusive Datacenters catering to their testing requirements.

The consolidation of the laboratories from various locations and the expansion in the operations posed a challenge to the existing conventional servers, both in performance as well as increased demand for infrastructure such as space, power and cooling. To meet the increasing growth, additional infrastructure was required.

In addition, the company had to compete with the power outages that impact the availability and performance of its R&D applications. The company recognized the need for newer, high-density equipment that would occupy less space and consume less power.

Project details

The company used a combination of its own technology, and advanced power and cooling systems to operate a state-of-the-art laboratory Datacenter in Bangalore. The Datacenter surmounts obstacles related to high electric power consumption and sets high standards for eco-responsible computing and overall operational efficiency.

Benefits of the project

- › 17% reduction in power Consumption and 15% reduction in Space Requirements
- › 154% Increase in Computing Capacity

The organization initiated the consolidation project, applying Datacenter design models, and services such as custom consolidation architecture, design and migration services(CADMS), etc. It had proved their ability to reduce operating costs and improve performance and availability at facilities worldwide. The consolidation resulted in migration of applications from approximately 300 older servers to 100 new higher servers.

The new high density servers presented a challenge to the conventional low density design of the cooling-system. The Datacenter design utilized a hot aisle containment technique based on Row Cooling (RC). The RC devices trap and neutralize the heat generated by the equipment to eliminate the

mixing of hot and cold air in the room. The units sense the temperatures and speed up or slow down the cooling fans as required, making for a very efficient solution. The Datacenter used standard racks that provide a consistent footprint for all users and allow space-saving dense cable configuration.

Results of the project

The consolidation has increased the computational capacity by 154% while reducing electric power consumption by 17%. While helping to reduce costs and power consumption, the new Datacenter design has also boosted productivity across the R&D services.

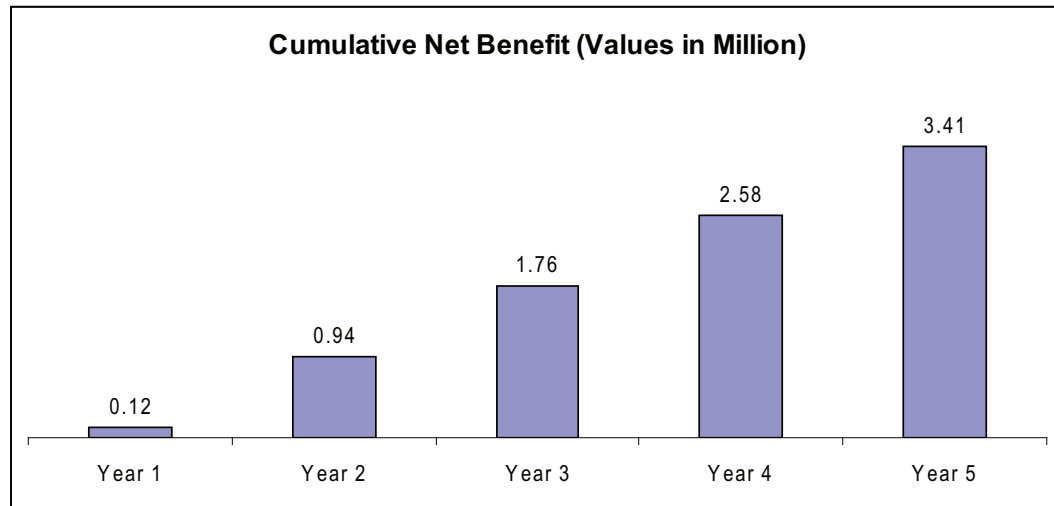

Figure 4.21: Cumulative Net benefit

The consolidation also offered more tools to engineers, with greater availability, better performance, and consistent resource for access.

The project resulted in cumulative five-year savings of Rs 3.4 million with the investment of Rs 0.93 million.

Cost benefit analysis

- Cumulative five-year savings - Rs 34 Lakhs
- Investment - Rs 9.25 Lakhs
- Payback Period - 10 months
- Annual ROI - 74%

Case Study 17

NETWORK VIRTUALISATION FOR PERFORMANCE IMPROVEMENT

The project discusses virtualization of campus wide networks for reducing complexity, increasing availability, manageability, security, scalability, and energy performance of the network.

Background

Data communication is one of major areas in IT business. A network is the integration of various IT and data transfer equipment to enable data process and secure data transfer. It is an integral part of IT operations.

Increasing business demand causes network to grow as a complex system. This increases the need for scalable solutions to segregate group of network users and their resource.

The increase in network size poses challenge to data security, access control, resource/service sharing, scalability, and energy performance.

Virtualization of a large network minimizes the operational complexity and improves data security. Network virtualization enables a single physical device or resource to act like multiple physical resource shared by the network.

Virtualization increases the utilization of network resource such as servers and storage-area networks (SANs). Various techniques such as centralized policy management, load balancing, dynamic allocation and virtual firewalls enhances network agility by improving efficiency and optimizing resource thereby reducing both capital and operational expense.

Also, the use of Layer-3 technologies such as GRE (Generic Routing Encapsulation) Tunnels and MPLS VPN enables a simple and effective approach to create closed user groups on a large campus wide network.

Authentication and Access-Layer Security is used for access control to mitigate threats at the edge and remove harmful traffic before it reaches the distribution or core layer.

Challenges faced

Access control: To ensure the recognition of legitimate users and devices and to classify and authorize to access the assigned portion of the network

Path isolation: To ensure the mapping of substantiated user or device to their available resources effectively; the right VPN (Virtual Private Network)

Services edge: To ensure the accessibility of services to the legitimate users and devices by centralized policy enforcement

Benefits of the project

- › Consolidate multiple networks into single network of high availability
- › Provides secured functioning by logically separating the customer networks
- › Ensures flexibility of network connectivity across the campus
- › Established a scalable platform to accommodate future growth needs

Consolidating multiple physical networks reduces operational cost and makes use of a single, scalable and easy-to-manage platform

- The project finds replication in scenarios with of large multiple independent networks
- The project involves major revamp of the networking infrastructure which requires external expertise. The project, being highly capital intensive, has to be taken up as part of a business decision

Case Study 18

EFFECTIVE STORAGE UTILIZATION OPTIMIZES DATACENTER OPERATIONAL COST

The project discusses the methods to improve the storage utilization rate and to reduce the operational cost in storage system.

Background

The company has a large, rapidly growing, and increasingly complex storage environment. Business growth drives increased enterprise transactions and usage of applications which had resulted in the expansion of storage system.

A study showed that a significant amount of capacity growth resulted from various factors such as under-utilizing existing capacity, storing duplicate copies of existing data, and retaining data that is no longer required.

At the end of 2007, the company managed 20 petabytes of primary and backup storage infrastructure constituting 7 percent of its Total Cost of Ownership (TCO), with storage capacity growing at

35 to 40 percent per year. It is the rate that would have lead to 90 petabytes of storage capacity by 2012 and also would have doubled the storage operational cost.

Key issues faced

The company has experienced difficulties in the following areas:

Demand forecasting

There was no specified requirement from the client/user or any effective tool or method for forecasting

Capacity management

Inadequate reporting on storage capacity and its performance led to inefficiencies in planning, provisioning, tiering and purchasing. Here again, inadequacy or nonexistent of tools made it difficult to forecast and maintain optimal storage capacity

Alignment between data value and storage technologies

Current method and tool limits the operations group's ability to effectively classify the data based on its business value and match it to appropriate storage infrastructure. This led to over-provisioning of storage services resulting in higher operational expenses

Archive and purge policies

The default methodology was to retain all the data irrespective of its business value with few broad policies or enforcement regarding retention and deletion of data. Data with little or no value was often retained indefinitely in costly primary-storage infrastructure, with multiple copies for operational and disaster recovery purposes.

Project details

The company adopted three key strategies for storage optimization.

Strategy-1: Virtualization, Tiering, and Application Alignment

Virtualization of storage enabled multiple systems to share and access a single storage device. The storage infrastructure included both SAN and NAS environments.

Virtualized storage environments enable tiered storage and transfers data amongst virtual storage machines with relative ease.

Tiering and application alignment had impact on performance by increasing utilization and scalability, enabling multi-vendor sourcing, and simplifying management. Tiering strategies reduced overall ownership cost of the storage.

Storage-Medium Allocation improvement was done through NAS/SAN virtualization, system-to-application mapping and alignment, and data migration

Strategy-2: Capacity Management

Capacity management had improved the utilization rate of storage devices by implementation of various techniques such as thin provisioning, fabric unification, storage reclamation and capacity management reports and metrics.

Strategy-3: Data Management

Data management technologies reduced the volume of data to be stored and restricted the capacity growth through various techniques like writable snapshots, de-duplication, Next-generation (D2D) backup and recovery, etc.

Benefits of the project

The estimated TCO in the full-potential scenario would just be 13 percent higher in 2014 than in 2007, while the estimated baseline TCO would experience a 279 percent increase in the same period. These numbers are a strong confirmation of the benefits of a holistic approach to storage optimization, and are reinforced by equally impressive results in controlling power consumption.

Table 4.4: Benefits of the project

Performance Indicator	2007 Actual Values	Baseline 2012 End Point	Optimized 2012 End Point	Baseline 2014 End Point	Optimized 2014 End Point
Total capacity (petabytes)	20	90	66	165	95
Power consumed (kWh/year)	18.0M	39.4M	29.1M	65.6M	34.9M
Required FTE headcount	95	140	90	166	90
TCO run rate	100%	200%	103%	279%	113%

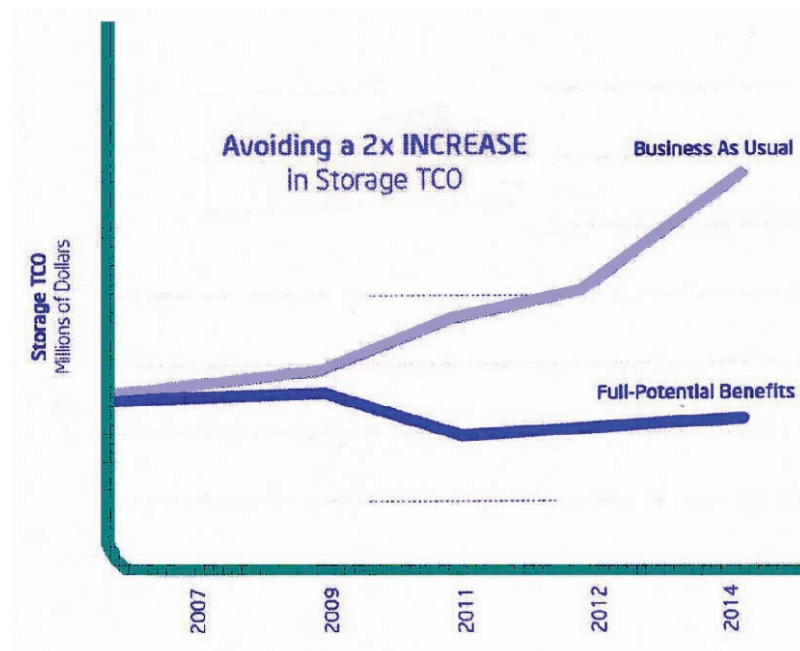

Figure 4.22: Storage TCO (Source : Intel)

- The project has a high replication potential where the storage cost is a significant part of the company's total operational cost
- The project involves major revamp of the storage infrastructure requiring external expertise. The project, being capital intensive, has to be taken up as part of a business decision

Case Study 19

INFRASTRUCTURE EFFICIENCY IMPROVEMENT IN A VIRTUALIZED ENVIRONMENT

Background

Virtualization of servers reduces server population and power and cooling requirements. Thus it results in reduced IT power consumption and overall Datacenter power consumption. The key characteristic of virtualization is the high density operation of servers. It also introduces new operational challenges into the Datacenter environment.

Key challenges in a virtualized environment:

Increased server criticality

Virtualization brings higher and higher processor utilization, increasing the business importance of each physical server, thus making effective power and cooling even more critical in maintaining availability.

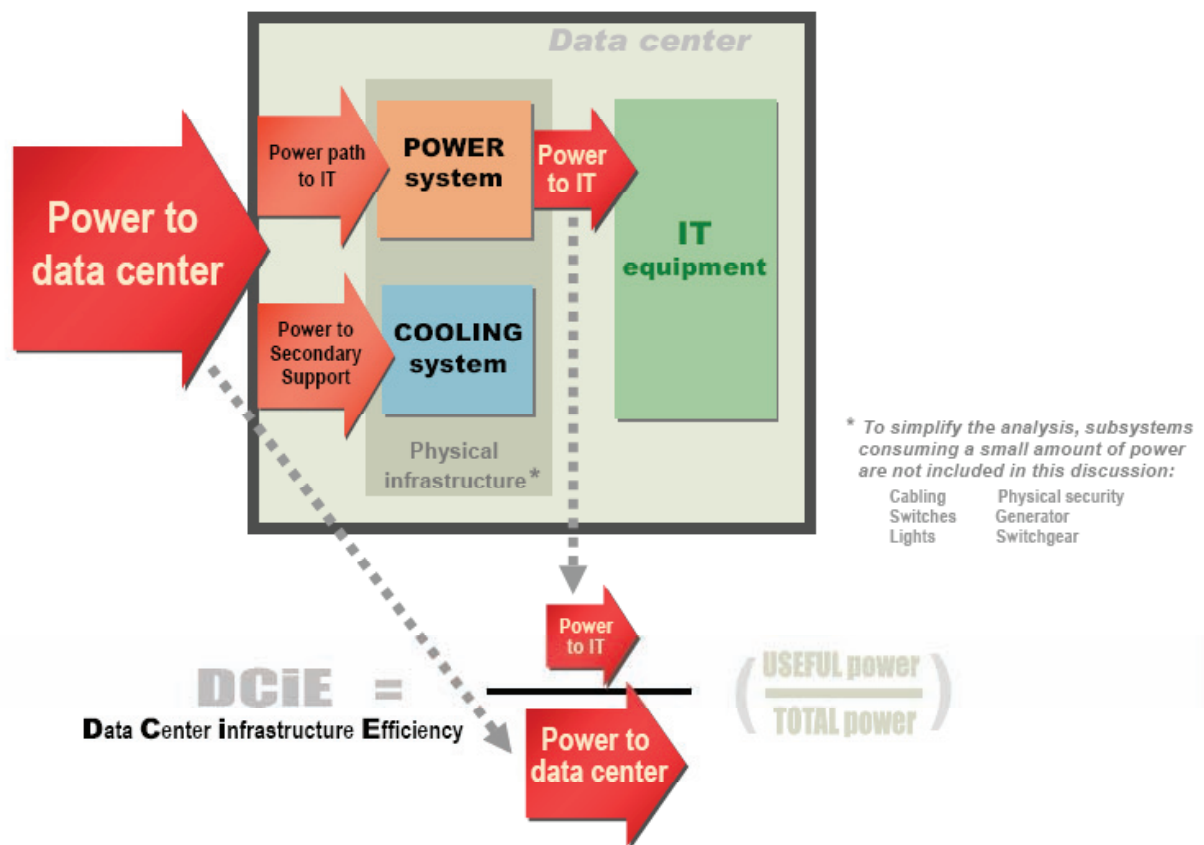

Figure 4.23 : Datacenter Infrastructure Efficiency (Source : APC)

Dynamic and migrating high-density loads

With virtualization, applications can be dynamically started and stopped, resulting in loads that change both over time AND in physical location. This adds a new challenge to the architecture and management of power and cooling

Under-loading of power and cooling systems

If power and cooling capacity is not optimized to the new lower IT load, Datacenter infrastructure efficiency (DCiE) will go down after virtualization. Therefore calling down of infrastructure to match the IT load further reduces the power consumption in the Datacenter.

Dynamic and migrating high-density loads

Virtualization enables dynamic load allocation to servers, and high processor utilization capability, inducing localized high-density hot zones in the Datacenter.

The dynamic loading of servers results in a shifting of the thermal profile of the room with no visible physical changes in equipment. The schematic condition is shown in figure 4.24.

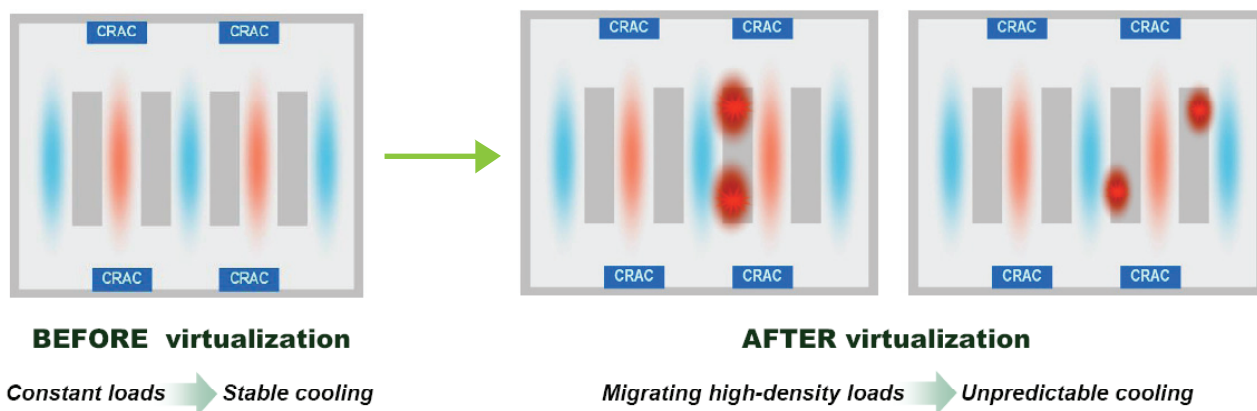

Figure 4.24 : Migration of load over a period of time in a virtualized environment (Source : APC)

Under such conditions, the conventional room based cooling technique sometimes becomes ineffective even with a cooling capacity of more than 2 times the actual required capacity.

Rack based cooling or targeted cooling located close to the load act as a supplement and provides an effective solution for efficiently removing the high density heat load. The figure 4.25 shows the schematic of row/rack based cooling system.

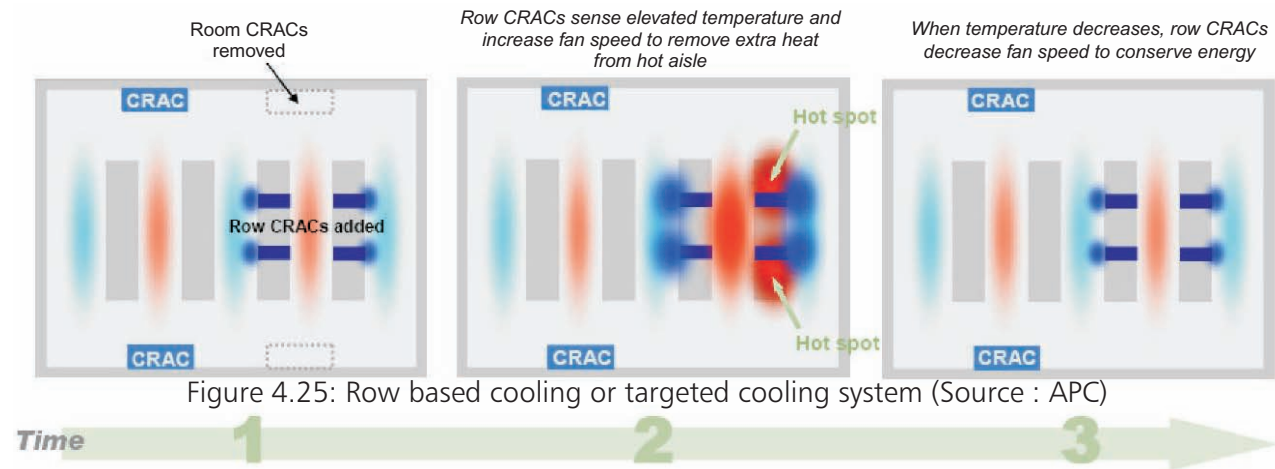

Figure 4.25: Row based cooling or targeted cooling system (Source : APC)

The key characteristics of a row based cooling system are:

- › Short air path between cooling and load
- › Dynamic response to load changes

A row based cooling system increases cooling system efficiency and availability by:

- › Reduced the mixing of cold supply air with hot return air
- › Increasing the return temperature (increasing the rate of heat transfer to the coil)
- › Targeted cooling that easily responds to localized demand
- › Conservation of fan power
- › Reduced – often eliminated – need for make-up humidification (to restore the moisture removed by condensation on a too-cold coil resulting from a too low set point)

Under-loading of power and cooling systems

The capacity of the power and cooling system is designed with high redundancy to maintain maximum uptime of the Datacenter. Operating the system with high redundancy levels has a tendency to under-load all the equipment, resulting in inefficient operation. It becomes difficult to improve the efficiency of the systems using conventional single core architecture, where the efficiency can be varied only by varying the load. Scalable and modular architecture provides idle platforms to overcome this difficulty - it provides options for controlling the number of modules in operation, maintaining the loading on individual modules at an optimum level.

Effects of under-utilization

All power and cooling devices have electrical losses (inefficiency) dispersed as heat. A portion of this loss is fixed loss – power consumed irrespective of the load. At no load (idle), the power consumed by the device does no useful work.

As load increases, the device's fixed loss stays the same, and other losses increase in proportion to the amount of load. This is called proportional loss.

As load increases, fixed loss becomes a smaller and smaller percentage of the total energy used, and as the load decreases, fixed loss becomes a larger percentage of the total energy used

Virtualization improves IT system energy performance and reduces the load on power and cooling systems. The reduction in load further reduces the loading on the power and cooling equipment, resulting in inefficient operation. Power and cooling devices that can scale down in capacity will reduce the fixed losses proportionally and increase operating efficiency. Scalable architecture will not only facilitate the downsizing of capacity which follows IT consolidation, but also subsequent growth by following the expansion of the virtualized IT load as shown in figure 4.26.

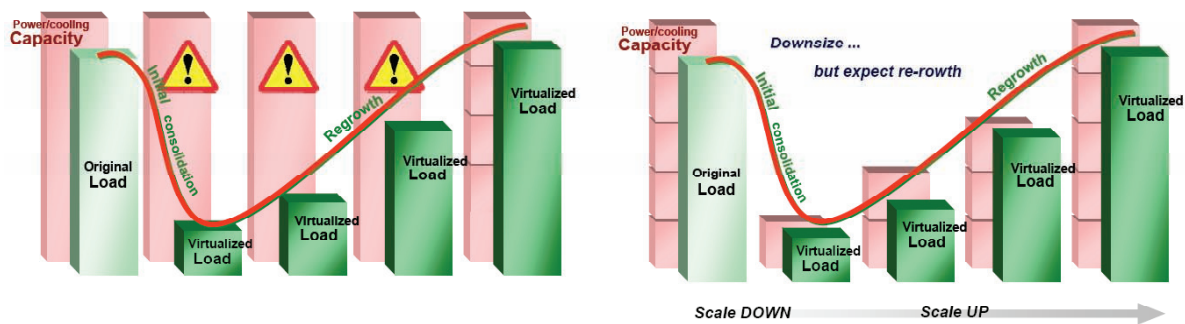

Figure 4.26: Scalable Power and Cooling to Minimize the Inefficiency of Unused Capacity during Consolidation and Growth (Source : APC)

Datacenter infrastructure efficiency (DCiE) will go down after virtualization, due to fixed losses in unused power & cooling capacity. With optimized power and cooling to minimize unused capacity, power and cooling efficiency (DCiE) can be brought back to nearly pre-virtualization levels – sometimes even better ones, depending upon the nature of improvements in the cooling architecture.

Datacenter Efficiency as a Function of IT Load

Datacenter efficiency is always higher at high IT loads. Therefore Datacenter efficiency is a function of IT load. A typical Datacenter infrastructure efficiency curve is shown in figure 4.27.

Every Datacenter will have a higher or lower infrastructure efficiency curve depending upon the efficiency of its individual devices and the efficiency of its system configuration. The curve always starts at zero and follow the shape shown in figure 4.27.

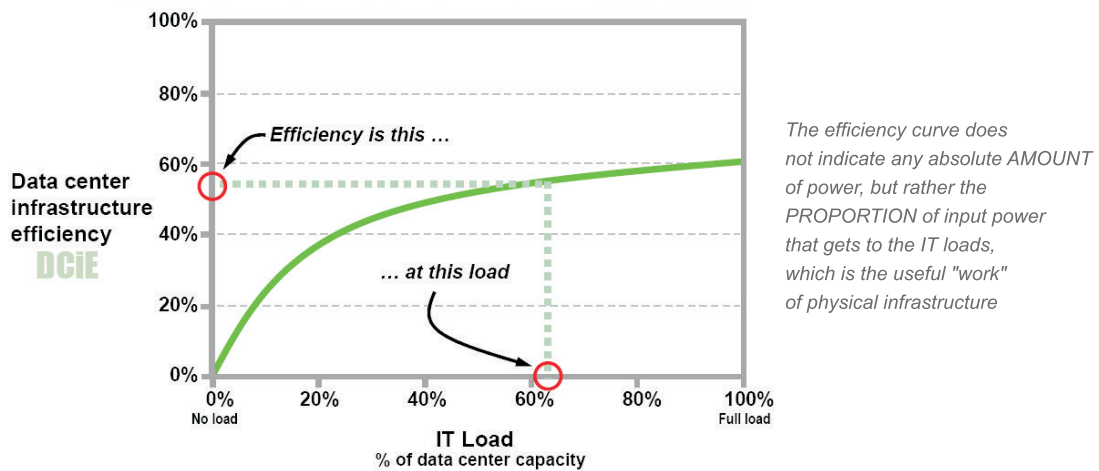

Figure 4.27 : Typical Datacenter Infrastructure Efficiency Curve (Source : APC)

Virtualization will always reduce power consumption due to the optimization and consolidation of computing devices. However, if no concurrent downsizing or efficiency improvement is done to power and cooling infrastructure, the infrastructure efficiency (DCiE) will move down on the curve because of the reduced IT load as shown in figure 4.28 below.

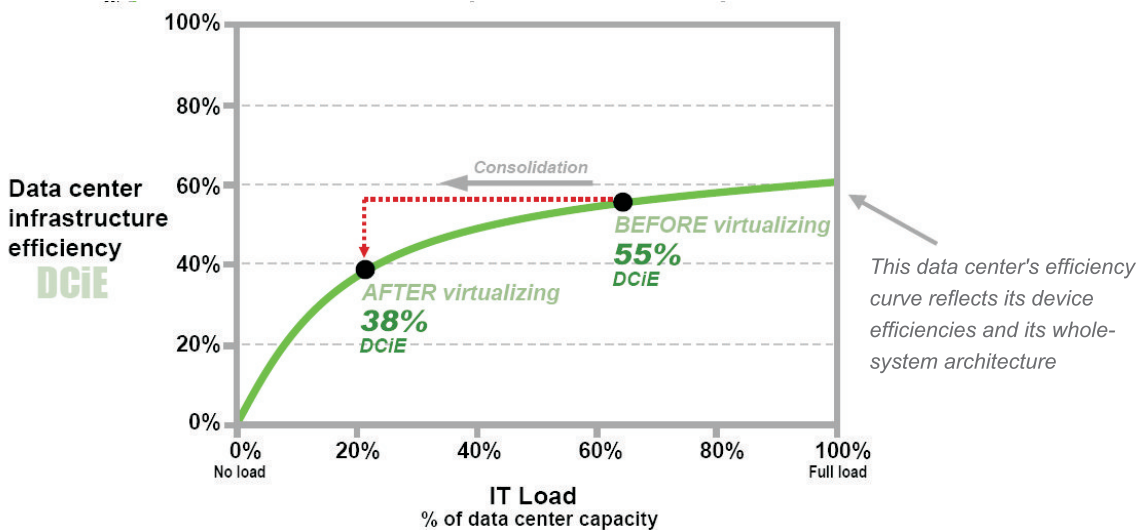

Figure 4.28 : Consolidation Reduces Infrastructure Efficiency if the Datacenter’s Infrastructure Remains Unchanged (Source : APC)

The Datacenter’s infrastructure efficiency curve must be raised by optimizing the power and cooling systems to reduce the fixed loss and optimize the infrastructure capacity to the new IT load. Optimization of infrastructure capacity would change the infrastructure efficiency curve and improve the post-virtualization DCiE as shown in figure 4.29.

The greatest impact on the efficiency curve can be made by going from room-based to row-based cooling and by “right-sizing” of power and cooling systems. In addition to improving efficiency, optimization of power & cooling will directly reduce power consumption.

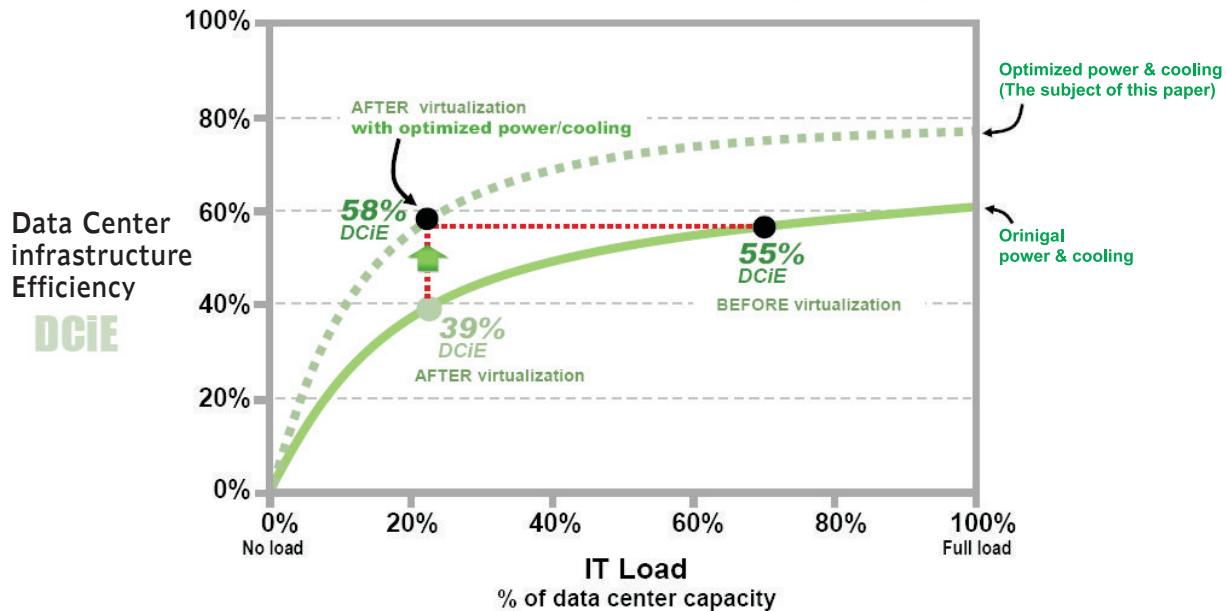

Figure 4.29 : Optimized Power and Cooling Raises the Efficiency Curve (Improves DCiE)
(Source : APC)

To realize the full energy-saving benefits of virtualization, the following design improvements can be incorporated:

- Power and cooling capacity scaled down to match the load
- VFD fans and pumps that slow down when demand goes down
- Equipment with better device efficiency to consume less power
- Cooling architecture with shorter air paths (e.g. changing from room-based to row-based)
- Capacity management system, to balance capacity with demand
- Blanking panels to reduce in-rack air mixing

The project has high replication potential in a virtualized environment

The project involves minor modification in power and cooling infrastructure, which requires external expertise. The project, being capital intensive, has to be taken up as part of a business decision

Chapter 5

Operation and Maintenance

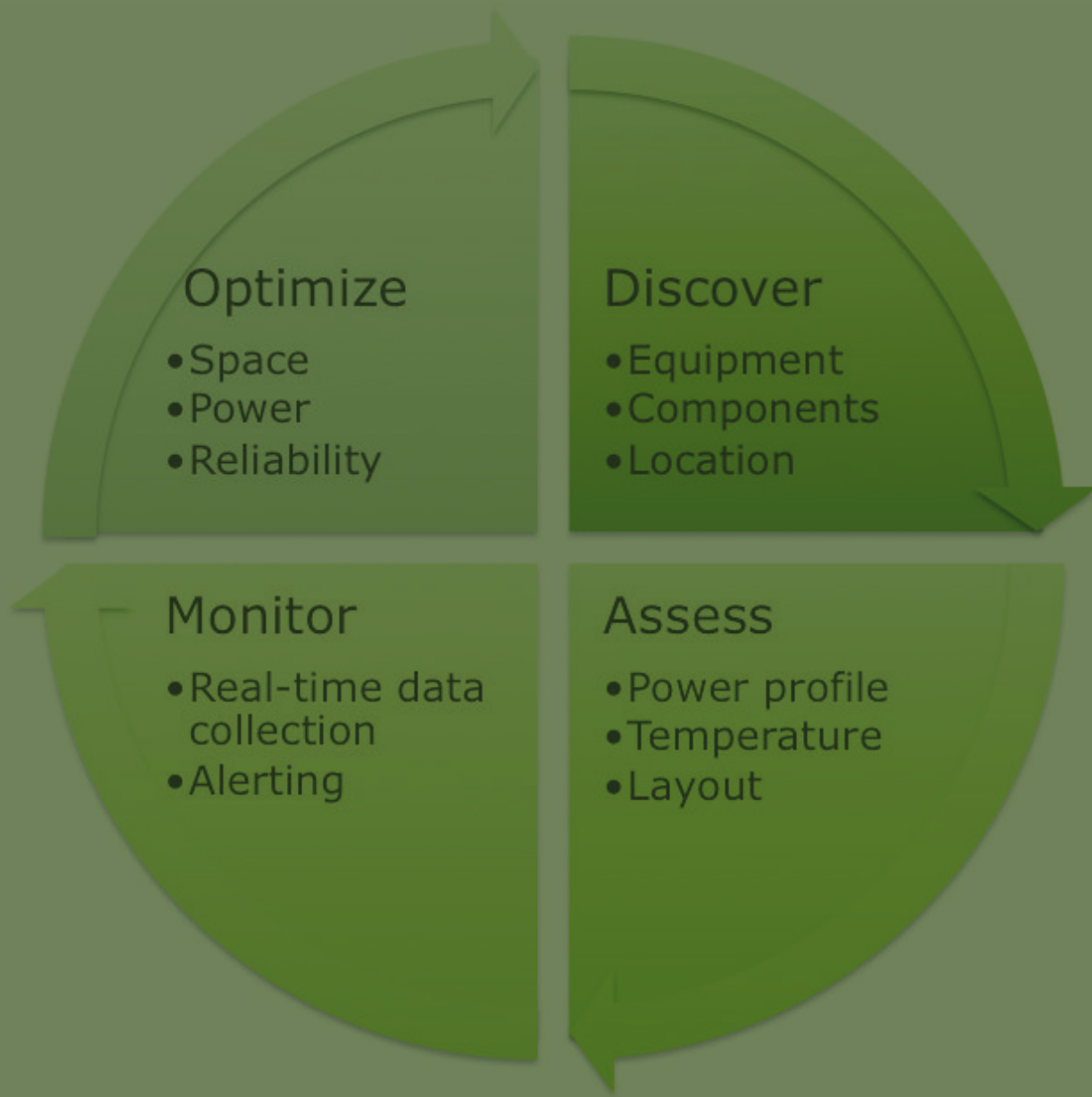

Summary Note on 'Data Centre Operations and Maintenance'

The Operations and Maintenance of critical facilities like Datacenters is recognized as an important tool for achieving operational excellence. Operational excellence translates into reliable, safe, secure and efficient operations of all the business systems in a Datacenter. As the robustness and associated complexity of critical infrastructures increase, the importance of establishing robust Operations and Maintenance practices to manage these facilities has become quite imperative. Once a Datacenter is designed and implemented, it becomes the responsibility of the operations and maintenance team to operate, monitor, report and maintain the infrastructure. Every site needs to define its key performance indices, and then monitor, report and drive for improvement. This can be done through proper auditing, logging and analysis of the key parameters.

It was therefore timely that the Confederation of Indian Industries (CII) under the guidance of the Bureau of Energy Efficiency (BEE), Government of India, took up this exercise of developing guidelines and best practices for Energy Efficiency in the Indian Datacenter. The exercise involved all the stakeholders coming under the domain and was indeed a 'one-of-its-kind' initiative.

This Chapter on 'Datacenter Operations and Maintenance' is the result of a collective effort focusing typically on the Management Information Systems (MIS) format and has captured the benefits through metering and monitoring systems for effective energy management and other related areas.

I am extremely thankful to all the members of this Group for their immense contribution towards the successful completion of this Chapter.

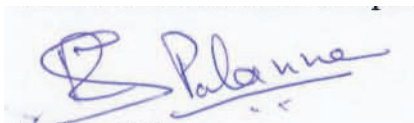

Sudeep Palanna

Chairman, Core Group on 'Operation and Maintenance' &
Facilities, Texas Instruments India Pvt Ltd

LIST OF MEMBERS ON OPERATION & MAINTENANCE (CORE GROUP-4)

Sl.No	Name	Organization
1	Mr Anand Vanchi	Intel Technology India Pvt Ltd.
2	Mr Anand Chandra Mouli	Infosys Technologies Ltd.
3	Mr Arun K. Bhat	Intel Technology India Pvt Ltd.
4	Mr Bhanu Kumar Jain	Spectral Services Consultant Pvt. Ltd.
5	Mr Karthikheyam DS	Wipro Infotech
6	Mr Manu Kumar	Hewlett Packard India Sales Pvt Ltd.
7	Mr Muthu Swamy	MIC Electronics Ltd
8	Mr Rishi Mehta	Tata Communications Ltd.
9	Mr. S Ramachandran	Tata Consultancy Services
10	Mr Ravi Meghani	Wipro Technologies
11	Mr Santhosh Srihari	WiproTechnologies
12	Mr Shailesh C. Zarkar	Iconic Designs Pvt. Ltd.
13	Mr Sharfoddin Mohammed	WiproTechnologies
14	Mr T.S. Shankar	Cisco Systems (India) Pvt. Ltd.
15	Mr. Sudhir Setty	Intel Technology India Pvt Ltd.
16	Mr Sudeep Palanna	Texas Instruments India Pvt Ltd.

5.1 Significance of Operation & Maintenance

the Operation & Maintenance for critical facilities like Datacenters is recognized as an important tool for achieving operational excellence. Operational excellence translates to reliable, safe, secure, and efficient operation of all the business systems in a Datacenter

As the robustness and associated complexity of critical infrastructures increases, the importance of establishing equally robust O&M practices to manage these facilities has become apparent.

“Operation and Maintenance team play a critical role in operating the infrastructure, and reporting its performance”

This activity includes routine switching and reconfiguration of critical systems, maintenance tasks. Once a Datacenter is designed and implemented, it is the responsibility of the operations and maintenance personnel to operate, monitor report and maintain the infrastructure..

One of the most important roles of an O&M manager is to draw the attention of the management through regular performance reports. Every site needs to define its key performance indices, monitor, report, and drive for improving indices. This can be facilitated by proper auditing, logging, and analysis of the key parameters. A typical MIS format is included in this chapter. A typical Management Information System (MIS) format can be referred to monitor the performance metrics of a Datacenter.

Adoption of best practices in operation and maintenance is an essential tool for achieving operational excellence in a Datacenter

5.2 Technical documentation & Internal training

Documentation of policy or procedure, guidelines, process standards, information of IT systems infrastructure and assets is crucial for business continuity and security in a Datacenter.

One of the major factors for poor documentation is allocation of inadequate time. This is common in many facilities due to the focus of maintenance personnel attending to existing issues.

Documentation of policy or procedure, guidelines, process standards, information of IT systems infrastructure and assets is crucial for business continuity and security in a Datacenter

The technical documentation shall comprise of the following:

- › Design intent with system description
- › Completed and approved testing and commissioning forms
- › Non conformation (NCR) items –Snag list completed and approved
- › Reports on training completion details of the operating and maintenance personnel
- › Equipment warranty information
- › Operation and maintenance (O&M) manual customized to the installed system
- › Standard O & M manual for all equipment
- › As-build drawings (Both in soft and hard copy)
- › Single-line diagrams /schematics of all systems (Mechanical, Electrical & Plumbing (MEP), Monitoring & Controls, Fire & safety) (soft and hard copies)
- › List of Spare parts and special tools to be used

5.3 Manpower and Training

The need and importance of having a well-defined and standardized operating and maintenance system will go a long way in the effective functioning of the Datacenter.

Technical training for Operation and Maintenance personnel is imperative to sustain the progress

The importance of having a properly defined and standardized operating and maintenance is a well – acknowledged fact in an industry.

Besides the regular trainings on O&M procedures, it is recommended that the operator should be sensitized to the energy and environmental impact of his or her actions. Lower energy and operating costs can be realized when every individual realizes the necessity of their contribution to the overall energy conservation.

5.4 Housekeeping

A site should have a defined and regular house keeping program. Maintaining a clean and dust-free environment has benefits in terms of better air movement through CRAC units and IT equipment.

Better air movement ensures proper heat transfer from the equipment and thus minimizes failures.

Adopting 5S methodology tools and techniques would facilitate in maintaining a clean and dust-free environment.

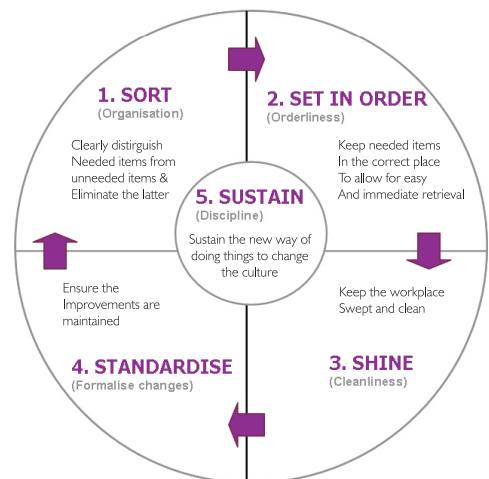

Figure-5.1:5S Methodology

The process of 5S is shown in figure 5.1. 5S methodology emphasizes self discipline, and orderliness. It is recommended to adopt 5S practices to organize and maintain the datacenter.

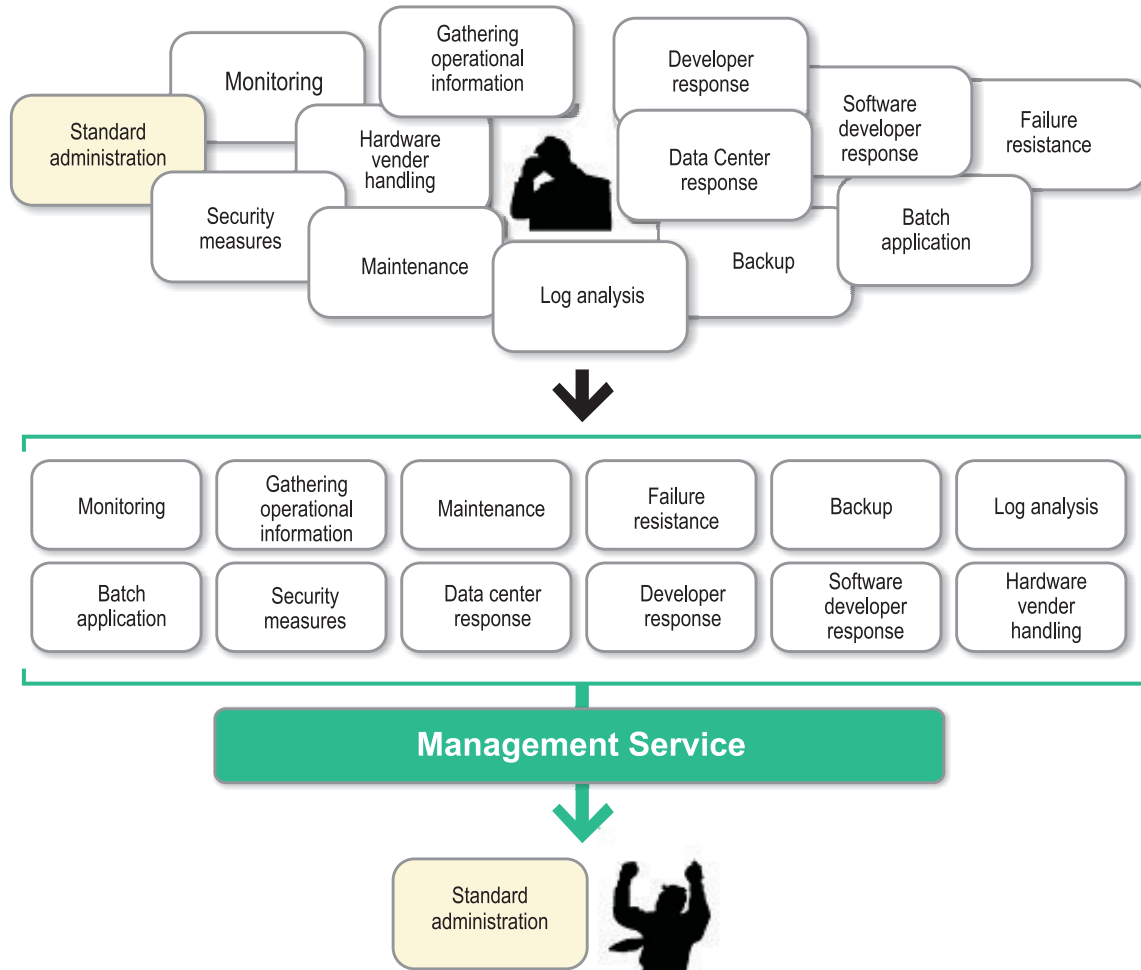

Figure-5.1A : Standardising the administration

5.5 Preventive maintenance

In most of the facilities, the preventive maintenance is a routine task based on time interval or frequency. The limitation however with the approach is that the tasks occur regardless of actual operating condition and generally involve a shutdown of the equipment, which may be difficult and not recommended in Datacenters.

Monitoring of metrics like Mean Time Between Failures (MTBF) can indicate the effectiveness of a preventive maintenance program.

5.6 Breakdown maintenance

Breakdown maintenance refers to repairs carried out after equipment has failed. In a datacenter environment, this could prove to be costly. Also, it is necessary to have a proper response mechanism to failures and a proper root-cause analysis to prevent future reoccurrences of the failure. Monitoring of indices like mean time between repairs is beneficial.

Source : Industry

5.7 Condition based monitoring

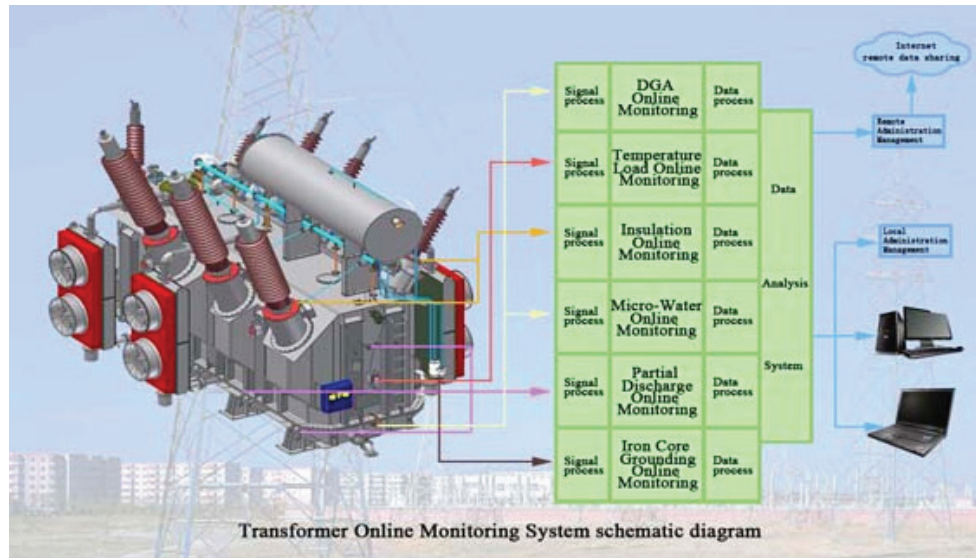

Figure- 5.2: Transformer online monitoring system

Condition based monitoring refers to technologies that allow maintenance to take place based on actual operating conditions. A simple example is using a differential pressure sensor to monitor filter condition. When the filter loads up, the pressure drop (ΔP) increases and the filter is replaced when appropriate.

Condition-monitoring technologies can be used to track real-time data and predict the necessary maintenance action required in advance. This is called predictive maintenance. Thresholds can be assigned for alerts and alarm conditions, and by analyzing the trends, one can predict the exceeding of thresholds and even failures. Figure 5.2 shows the online monitoring of transformer.

Some examples of operating condition monitoring technologies include vibration analysis and infrared thermal scans. These technologies are used to analyze the operating condition of the equipment while the equipment is online, without requiring shutdowns or maintenance outages.

5.8 Capacity vs Utilization

Monitoring of capacity versus utilization is very important as it provides opportunities for improving the energy efficiency levels in equipment. Continuous monitoring of equipment and MIS data facilitate IT managers to take action for improving energy efficiency by reducing energy loss in CPU, storage, UPS, etc.

Higher capacity utilization improves the operational efficiency levels in a Datacenter

5.9 Metering & Calibration

To maintain competitive advantage, proper control of input and output is necessary. Effective metering and monitoring system provides savings in three dimensions.

1. Reduction in energy consumption gives monetary benefits
2. Optimization of Equipment utilization, deferring capital cost for expansion by better utilizing the existing infrastructure
3. Improves system reliability by discovering the improvement opportunities with powerful metering that offers extremely accurate and high speed event capture information

The selection of the location of metering devices should be in accordance with PUE Calculation. All Electrical, Cooling and lighting energy should be measurable at the input and output points in the cycle. Case study included later in this chapter discusses the topic in detail.

Periodic calibration of all sensors and metering devices is crucial, and significantly affects the appropriateness of monitoring and control systems. Every site should have a calibration program implemented by a reputed calibration agency.

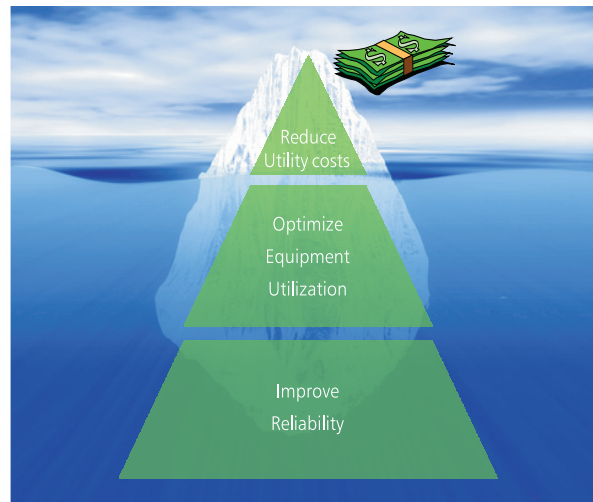

5.10 Routine audits

Due to the dynamic nature of the operations, the conditions inside the datacenter can vary considerably from the original design intentions.

To control and check such conditions, routine audits can be done manually in the absence of automated data collection instrumentation.

These audits help to generate information for managing change and also identifying potential problems.

Examples of some of the recommended audits are:

- › Capacity audit
- › Availability audit

- › Reliability audit
- › Asset audit
- › Security audit
- › Safety audit

5.11 Change management

IT downtime of any scale has a negative impact on business values and growth. Maintenance professionals face continuous challenge in minimizing the downtime of a Datacenter.

Also, the process of any changes for the improvement in the infrastructure involves certain amount of downtime depending on the changes proposed and procedure adopted.

To address the challenge of minimizing downtime involved in the process of making changes in infrastructure, the operations team approaches the process of change, in steps, referred to as the Change management process. Change management is a planned approach to integrate technological change in the current system and process. It provides smooth implementation of patches, upgrades and other changes in the infrastructure.

The Change management process has a set of procedures which provides a platform to assess the risk which leads to down-time and takes necessary precautions to minimize downtime during the change process. Therefore the process reduces the risk involved significantly and helps to maintain less downtime.

A systematically managed change would utilize the information collected from various studies and propose changes in infrastructure to ensure the overall optimization and performance in the Datacenter.

The information collection primarily focuses on:-

- › Availability of space
- › Availability of power and cooling
- › Energy performance of the proposed change

The user demand of 100% up-time of services and networks force the IT operations to deploy changes that aren't adequately tested against the entire infrastructure.

Presently, the implementation of changes has become one of the major causes of downtime with 10% of average roll back from production. A mature change management process would control IT changes, through testing and change impact analysis and reduces downtime risk.

IT operations often attempt to test and deploy the changes in a representative end-to-end pre-production staging and testing environment. Creating a dedicated staging environment solely used for IT testing will generate significant and measurable benefits. The completeness of testing is the final factor in change management maturity. To test on every change is a decision that an IT organization should make to balance against other priorities.

Flow chart on Steps for effective change process

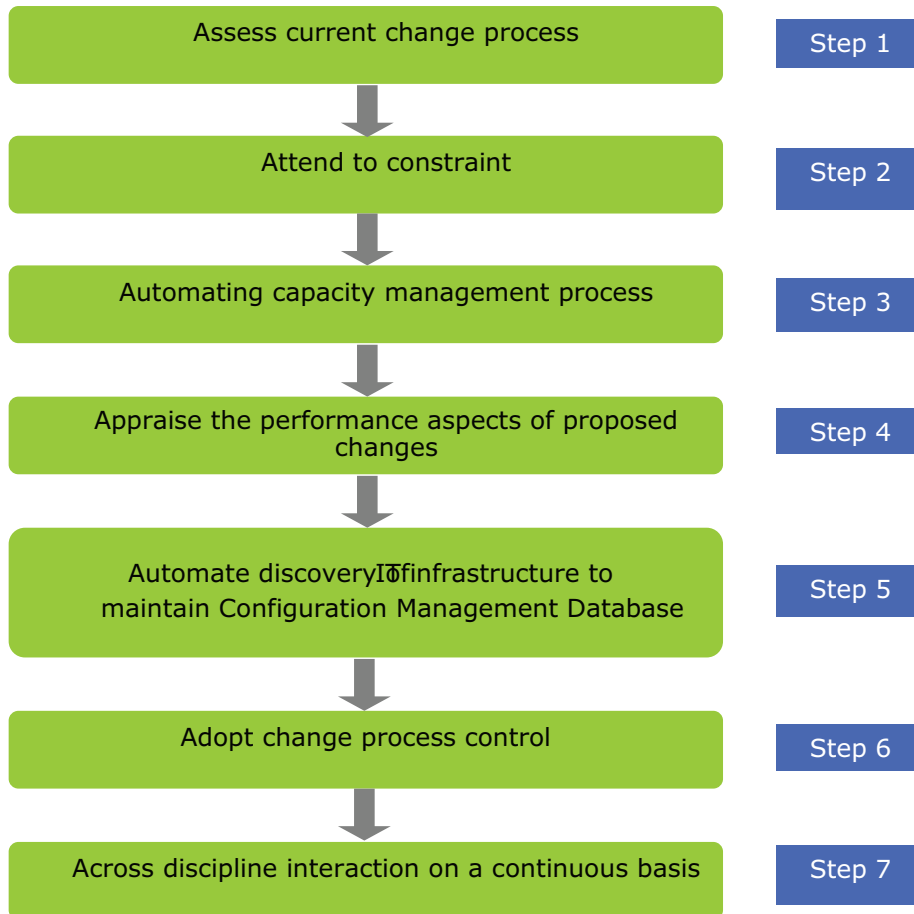

At any point on the change management path, there are steps that can accelerate the progress towards effective change management across the data center.

The steps described below can make major stride towards successful change management.

Step 1: Assess current change process

The first step in any change management process is to assess the current change process and evaluate its compliance with regulations for a change management.

The assessment can be performed by internal auditors with the help of 'Global Technology Audit Guide (GTAG)' published by the Institute of Internal Auditors (IIA).

The guide provides insight into symptoms and risk indicators of poor change management processes and serves as a useful tool to understand the level of effectiveness of existing change process.

Step 2: Address the constraints

Step-1 would reveal the constraints in the current process for effective change. The IIA guide would facilitate in overcoming the constraint as it defines actions that immediately improve change processes. In addition, process workflow has to be established in a variety of areas, including:

- › Automate change request initiation and routing of request for approvals
- › Planning, scheduling and implementation to set priorities
- › Implement processes for distributing patches and upgrades
- › Risk assessment to evaluate the impact of change on service levels, operational performance, and availability to ensure adequate IT resources to sustain the changes
- › Business continuity to ensure rapid recovery when problems occur

Step 3: Automating capacity management process

The responsiveness in making needed changes and controlling change has to be balanced to minimize disruption to the business. Automating the capacity management process increases speed and efficiency and eliminates repetitive tasks to achieve the balance.

Automating capacity management and resource provisioning brings the right resources online when they are needed to provide optimum efficiency, agility, and service levels.

Step 4: Assess the performance aspects of proposed changes

Making a consolidated view of all assets, their configurations, and their physical and logical dependencies provides easy approach to make changes.

The change activities should be prioritized based on business impact by creating the models that map the infrastructure components and business services they support. To ensure cost efficiency of configuration-related changes, it is necessary to consolidate the performance aspects of proposed changes before authorizing the changes.

It's important to consider the business service levels before, during, and after changes are implemented. This is needed to verify the value/impact and take necessary steps to support change management.

The track and report on change activities are important to enhance the change planning, facilitates audits, monitors the effectiveness of change management.

Step 5: Automate discovery of IT infrastructure to maintain configuration management database

A key requirement for effective change management is to maintain a configuration management database (CMDB) that includes all IT assets along with detailed information on locations, configurations, and users. CMDB should also capture the function of assets to the business services they support.

Automatic discovery would enable updating of changes to CMDB and provides a comprehensive data source for generating the views of the IT infrastructure that the data centre staff needs for change planning and management.

Step 6: Adopt change process control

Controls reduce risk of outages due to poorly planned or unauthorized changes, and the risk of regulatory noncompliance. Control in change process can be accomplished by enforcing policies that define processes, such as change requests and approval workflow, authorization of staff members to implement changes, and deployment of standard configurations.

Step 7: Across discipline interaction on a continuous basis

Change management is one of the number of IT Service Management disciplines. The change management solution should integrate all IT Service Management solutions to enable better interaction across disciplines.

Adopting best practices helps IT operations establish the environment and approach to understand the impact of change in the system rather than only prioritizing which changes to test.

An organization can establish matured change management processes by adhering to fundamental principles and also by implementing best practices and standards from similar organizations.

A matured change management process would result in minimizing the operational downtime of the facility and provides excellent business value.

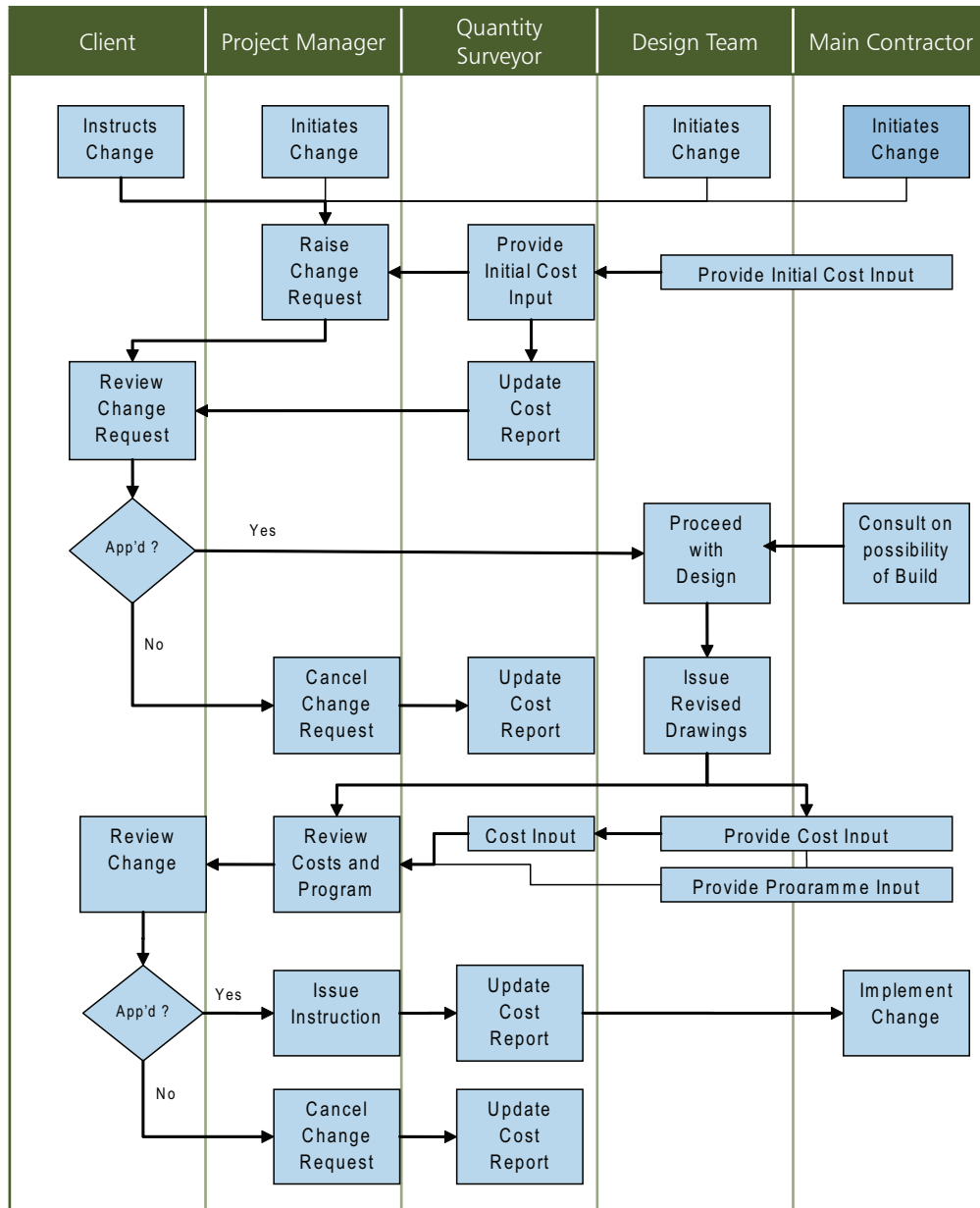

FIGURE- 5.3: TYPICAL CHANGE CONTROL FLOW CHART

5.12 Management Information System (MIS)

MIS is a powerful tool which has immense potential to drive changes and to lower the energy and operating costs.

At various management levels, the influence on MIS format varies. For example, as shown in figure 5.4, strategic planning-level managers prefer information in a summary format, whereas operational control-level managers prefer information in detail.

Therefore the monitoring system should have the detailed information of the system and provide a summary of the same.

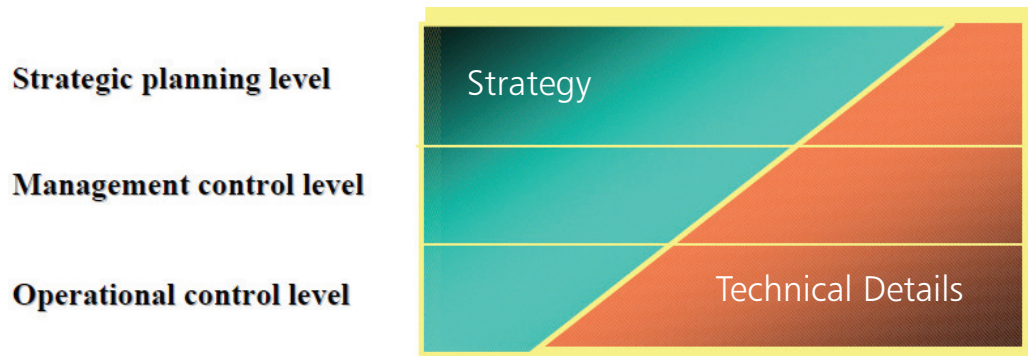

Figure 5.4: Influence of management level on Information format

Any operations and maintenance strategy should balance the availability of energy and system performance. A combination of different approaches is required to obtain optimum performance.

A typical MIS format is included later in this chapter. The MIS format can be referred to monitor the performance metrics of a Datacenter.

Outlined below in this section are few typical indices used in the industry for energy performance monitoring.

5.12.1 Datacenter performance metrics

The energy performance of equipment can be assessed by the standard metrics available in practice. The assessment becomes complex when a datacenter is assessed for overall energy performance. The complexity arises due to different opinions on accounting of energy use for the components within the Datacenter premises for performance evaluation.

BEE recommends the use of the following metrics and tools to analyze the energy performance of a Datacenter. It enables the Datacenter professionals to understand the overall system in a better way and facilitate in improving the energy efficiency levels. It also provides a common platform for comparing the performance levels with other Datacenters.

POWER USAGE EFFECTIVENESS (PUE) AND DATACENTER INFRASTRUCTURE EFFICIENCY (DCiE)

$$PUE = \frac{\text{Total facility power}}{\text{IT Equipment power}}$$

$$DCiE = \frac{1}{PUE} = \frac{\text{IT Equipment power}}{\text{Total facility power}}$$

In the above equations, the Total Facility Power is defined as the power measured at the utility meter - the power dedicated solely to the datacenter. This is important in mixed-use buildings that houses datacenters as one of a number of consumers of power.

The IT Equipment Power is defined as the equipment that is used to manage, process, store, or route data within the data center. It is important to understand the components for the loads in the metrics, which can be described as follows:

1. IT equipment power

This includes the load associated with all of the IT equipment, such as compute, storage, and network equipment, along with supplemental equipment such as Keyboard, Video or Visual display unit, Mouse (KVM) switches, monitors, and workstations/laptops used to monitor or otherwise control the datacenter.

2. Total facility power

This includes everything that supports the IT equipment load such as:

- › Power delivery components such as UPS, switch gear, generators, PDUs, batteries, and distribution losses external to the IT equipment
- › Cooling system components such as chillers, computer room air conditioning units (CRACs), direct expansion air handler (DX) units, pumps and cooling towers
- › Compute, network, and storage nodes
- › Other miscellaneous component loads such as datacenter lighting

The process of establishing the PUE or DCiE metric would be useful to determine:

- Opportunities to improve a datacenter's operational efficiency
- Comparisons with other datacenters
- Energy saving achieved through implemented measures, designs and processes
- Opportunities to re-route energy for additional IT equipment

As per the above explanations, both of these metrics imply the same; they can be used to illustrate the energy allocation in the Datacenter in a different way, as shown in the subsequent examples.

Example 1 - If a PUE is determined to be 2.0, this indicates that the datacenter demand is two times greater than the energy necessary to power the IT equipment. In addition, the ratio can be used as a multiplier for calculating the real impact of the system power demand.

Example 2 - If a server demands 400 watts and the PUE for the datacenter is 2.0, then the power from the utility grid needed to operate 400 watts server is 800 watts.

DCiE is quite useful as well. A DCiE value of 50% (equivalent to a PUE of 2.0) indicates that the IT equipment consumes 50% of the power in the datacenter.

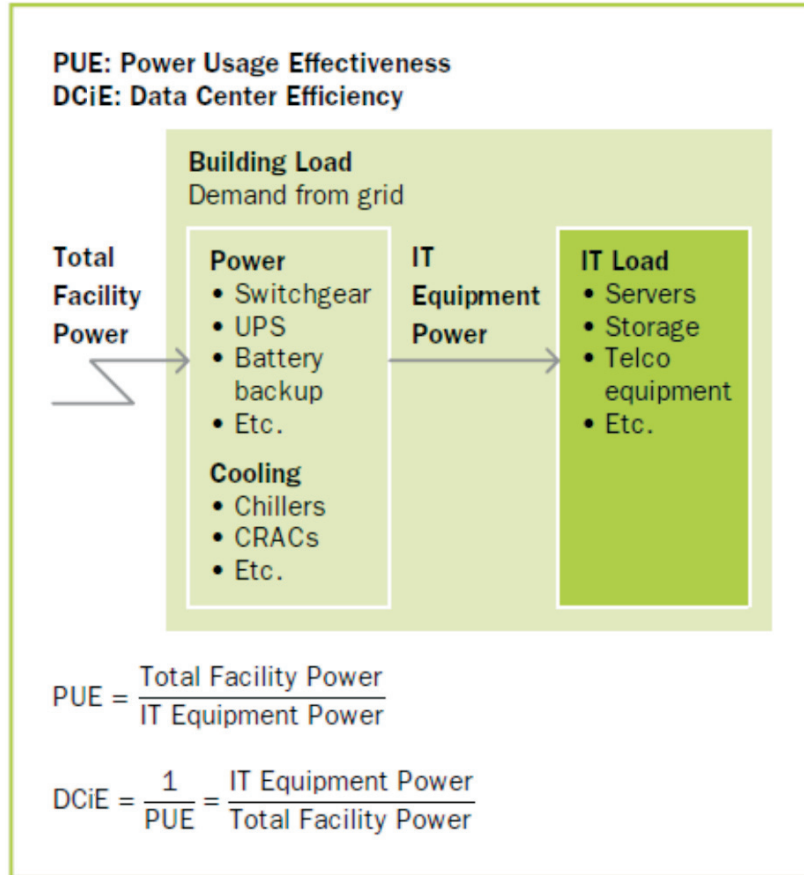

Figure - 5.5: Power flow in a Datacenter

The utility metering in a multi-part building should have an exclusive meter for datacenter operation, since power not intended to be consumed within the datacenter would result in faulty PUE and DCiE metrics. For example, consider a datacenter located in an office building. The total power drawn from the utility will be the sum of the Total Facility Power for the datacenter, and the total power consumed by the non-datacenter offices. In this case the datacenter administrator would have to measure or estimate the amount of power being consumed by the non-datacenter offices (Estimation technique will introduce error in the calculation).

IT Equipment Power is measured after all power conversions, switching, and conditioning is completed and before the IT equipment itself is considered. The most likely measurement point would be at the output of the computer room power distribution units (PDUs). The measurement should represent the total power delivered to the compute equipment racks in the datacenter.

Typically, the PUE range varies from 1.0 to 2.2. Ideally, a PUE value approaching 1.0 would indicate 100% efficiency. (i.e. all power being used by IT equipment only)

3. CUPS / WATT METRICS

Datacenter efficiency can also be estimated in CUPS/Datacenter Watts metrics. As discussed earlier, using a low power processor can give cascading gains in energy savings. Based on this premise, calculating Datacenter efficiency in terms of computing performance per watt usage makes more sense. CUPS stands for Compute Usage Per Second. CUPS represents a proxy for a universal measure of computing output.

$$\text{Data Center Efficiency} = \frac{\text{Data Center Output}}{\text{Energy Consumed}} = \frac{\text{CUPS}}{\text{Watts Consumed}}$$

5.12.2 Rack cooling performance index

Recommended Thermal Conditions:

The thermal conditions that may occur in a Datacenter are depicted in the figure 5.6. First, facilities should be designed and operated to target the recommended range. Second, electronic equipment should be designed to operate within the extremes of the allowable operating environment. Prolonged exposure to temperatures outside the recommended range can result in decreased equipment reliability and lowered longevity; exposure to temperatures outside the allowable range may lead to catastrophic equipment failures. The recommended range and the allowable range vary with the guidelines or standards used. For recommended temperatures, the ASHRAE thermal guideline lists 68°- 77°F (20°-25°C) for a “class 1” environment.

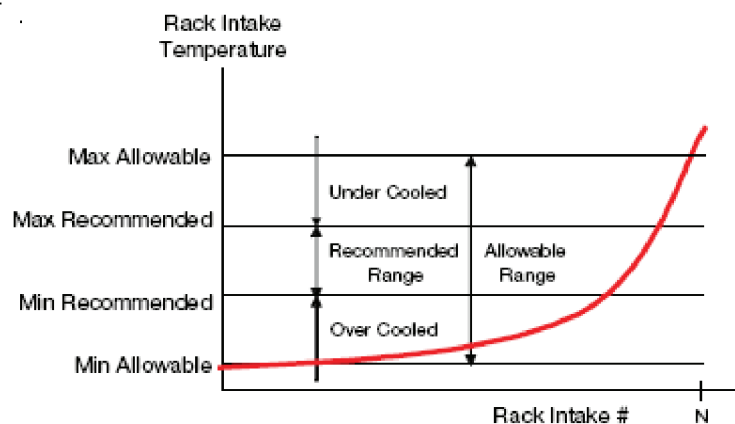
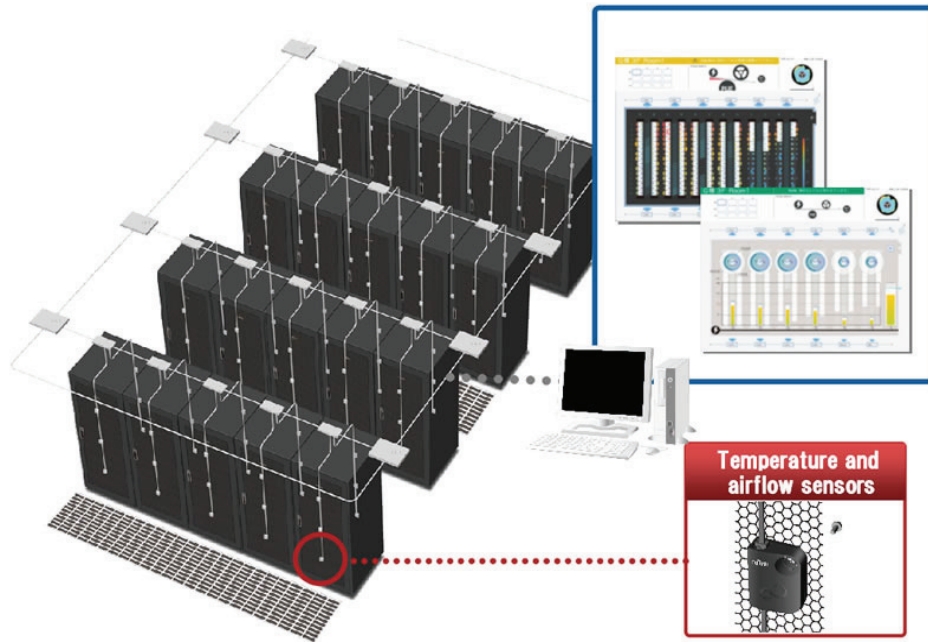

Figure – 5.6: Rack Intake (vs) Rack Intake temperature

Rack Cooling Indices (RCI):

The RCI is a metric used to measure the thermal condition of the electronic equipment. Specifically, the RCI_{hi} is a measure of the absence of over-temperatures (under-cooled conditions); 100% means that no over-temperatures exist, and the lower the percentage, the greater the probability that equipment experience excessive intake temperatures. RCI values below 80% are generally considered “poor”.

Rack cooling indices are unit-independent indicators of cooling in a datacenter.



There are four types of temperatures defined for a rack or server, they are:

- › Maximum allowable temperature
- › Maximum recommended temperature
- › Minimum recommended temperature
- › Minimum allowable temperature

Based on these temperatures, unit-independent rack cooling indices RCI_{hi} and RCI_{lo} are formulated as below

$$RCI_{hi} = \{1 - [\sum (T_x - T_{max-rec})] / \{ (T_{max-all} - T_{max-rec}) n \} \} 100 \%, \text{ for } T_x > T_{max-rec}$$

Where T_x Mean temperature at intake x [$^{\circ}\text{F}$ or $^{\circ}\text{C}$]

n Total number of intakes

$T_{max-rec}$ Max recommended temperature per some guideline or standard [$^{\circ}\text{F}$ or $^{\circ}\text{C}$]

$T_{max-all}$ Max allowable temperature per some guideline or standard [$^{\circ}\text{F}$ or $^{\circ}\text{C}$]

$$RCI_{lo} = \{1 - [\sum (T_{min-rec} - T_x)] / \{ (T_{min-rec} - T_{min-all}) n \} \} 100 \%, \text{ for } T_x < T_{min-rec}$$

Where	T_x	Mean temperature at intake x [$^{\circ}\text{F}$ or $^{\circ}\text{C}$]
	n	Total number of intakes [–]
	$T_{\text{min-rec}}$	Min recommended temperature per some guideline or standard [$^{\circ}\text{F}$ or $^{\circ}\text{C}$]
	$T_{\text{min-all}}$	Min allowable temperature per some guideline or standard [$^{\circ}\text{F}$ or $^{\circ}\text{C}$]

The interpretation of the indices is as follows:

$\text{RCI}_{\text{hi}} = 100\%$ All intake temperatures \leq max recommended temperature

$\text{RCI}_{\text{hi}} < 100\%$ At least one intake temperature $>$ max recommended temperature

$\text{RCI}_{\text{lo}} = 100\%$ All intake temperatures \geq min recommended temperature

$\text{RCI}_{\text{lo}} < 100\%$ At least one intake temperature $<$ min recommended temperature

The index is used to estimate the cooling level, which can be compared to the standard level specified by the equipment manufacturer.

After calculating the index, based on the inference, the maintenance team can formulate specific steps for performance improvement.

Case Study 20

CAPTURING THE BENEFITS THROUGH METERING AND MONITORING SYSTEM FOR EFFECTIVE ENERGY MANAGEMENT

Background

The case represents the development of a comprehensive approach to meter the power usage in the Datacenter and the adoption of appropriate instruments to continuously monitor the power usage effectiveness (PUE), the key index of Datacenter energy efficiency.

The primary goal of the initiative was to identify current operating costs, set baseline measurements, and implement improvement measures based on information gathered on a continuous basis.

The facility is a five year old Datacenter in Bangalore, India. The data center measures 5500-square-feet with a conventional design such as a 24-inch raised floor, a 10-foot-high false ceiling, and using a room cooling technique. The Datacenter has a power density of 110 watts per square foot (WPSF), a 2(N+1) UPS power redundancy configuration, and ductless chilled-water-based precision air conditioning (PAC) units in an N+1 cooling redundancy configuration.

The energy efficiency of the Datacenter was improved by metering and continuous monitoring of electrical energy consumption.

Continuous monitoring has enabled continuous tracking of PUE, the key Datacenter efficiency index. It is achieved through implementing instrumentation at a very micro level.

Metering the facility's Energy utilization in IT and cooling, and estimating losses at key points in power distribution provided useful information towards planning and implementing efficiency improvements.

Issues faced in establishing baseline measurement

The datacenter maintenance team faced difficulty in:

- › Isolating Datacenter power and cooling loads from the loads of the rest of the building

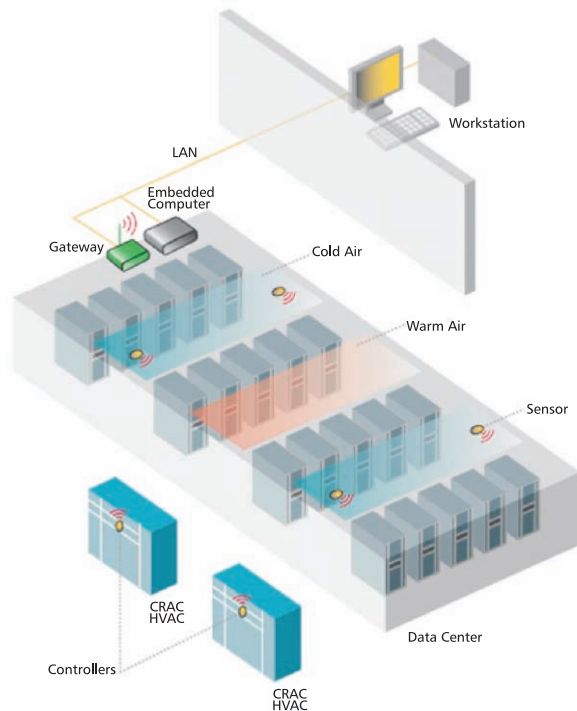

- › Metering the utilization of IT power, and cooling power at the right points in the power distribution cycle to facilitate collection of useful information for efficiency improvements
- › Identifying the optimum levels of granularity for energy metering

Project details

The metering was done at three different levels to measure the total facility power, IT equipment power, and cooling system power. Table 5.1 describes the location of meters in the system.

Table 5.1: Location of Datacenter power and cooling meters

Power metering	<ul style="list-style-type: none"> ▪ Input side: uninterruptible power supply (UPS) input panel ▪ Output side: row-level power distribution panel
Cooling metering	<ul style="list-style-type: none"> ▪ Precision air conditioning (PAC) units: at distribution panel supplying power to the PAC units ▪ Multi-use chiller plant: used flow meters and temperature sensors to isolate cooling consumption of the data center alone

Total facility power

Total facility power is the power measured at the utility meter that is dedicated solely to the Datacenter. Datacenter total facility power includes everything that supports the IT equipment load, such as:

- › Power delivery components including UPS, switch gears, generators, power distribution units (PDUs), batteries, and distribution losses external to the IT equipment
- › Cooling system components such as chillers, computer room air conditioning (CRAC) units, direct expansion (DX) air handler units, pumps, cooling towers, and automation
- › Compute, network, and storage nodes
- › Other miscellaneous component loads, such as Datacenter lighting, the fire protection system, and so on

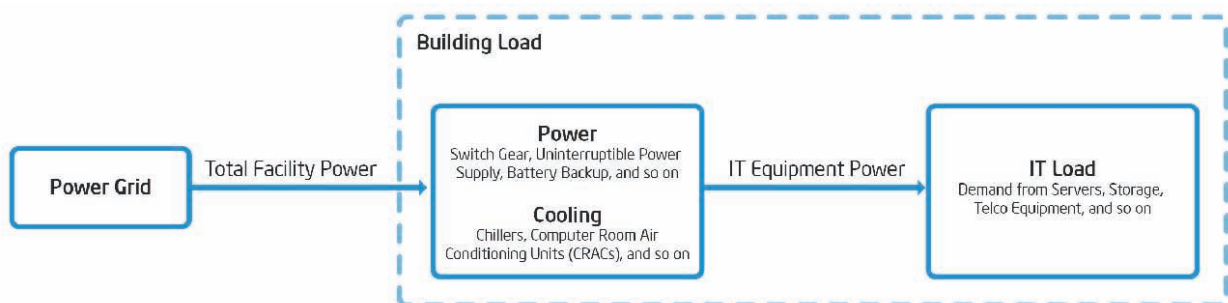

Power Usage Effectiveness (PUE) = Total Facility Power/Total IT Equipment Power

Data Center Efficiency (DCE) = 1/PUE = Total IT Equipment Power/Total Facility Power

Figure 5.7 : Total facility power measurement

IT equipment power

IT equipment power is defined as the effective power used by the equipment that manages, processes, stores, or routes data within the raised floor space.

The IT equipment load includes:-

- › The load associated with all of the IT equipment such as compute, storage, and network equipment
- › Supplemental equipment such as keyboard, mouse, switches, monitors, workstations and Laptops used to monitor or otherwise control the Datacenter

Continuous monitoring of row-level energy consumption was found to be the more effective approach to establish base line figures. Figure 5.8 shows the layout of Energy meters in the UPS system to measure total IT power.

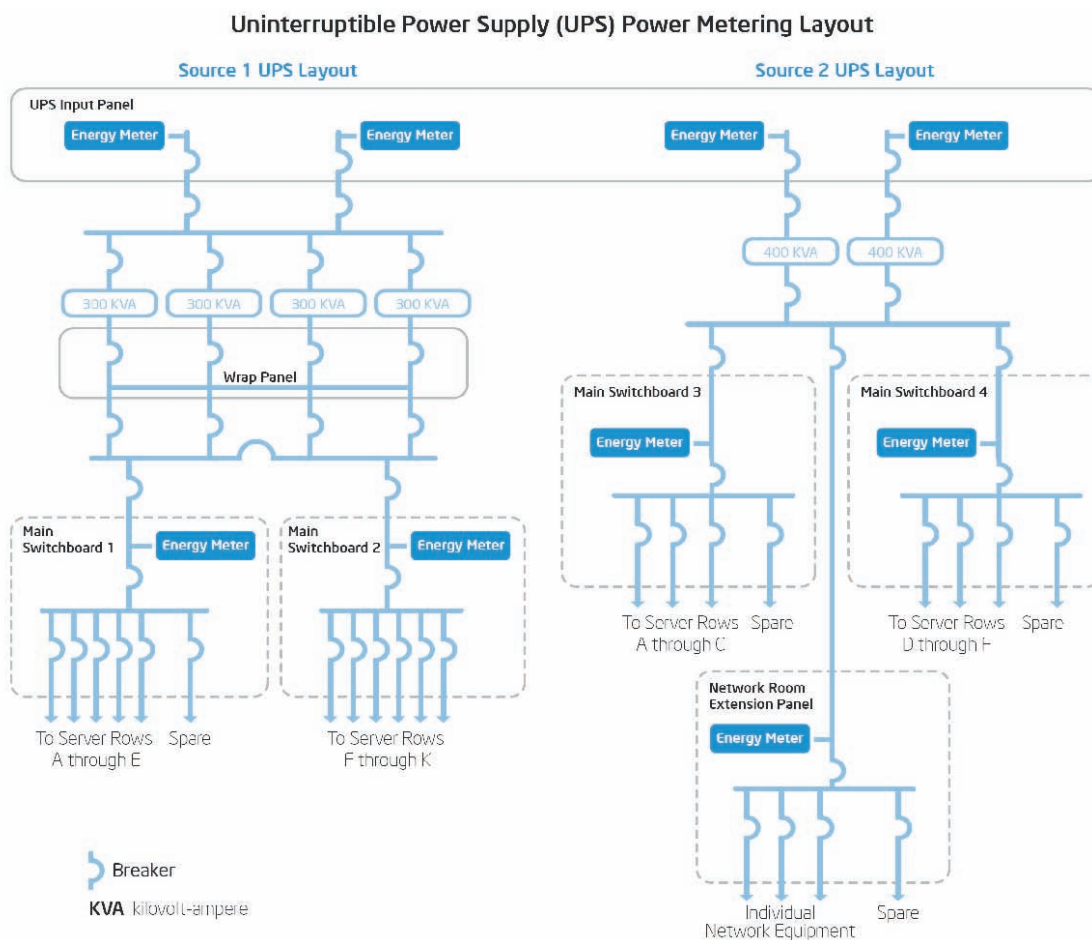

Figure 5.8: UPS metering layout to measure total IT power

To estimate the total IT power, energy meters were installed to measure the energy consumption at the row level in the Datacenter. This enabled the metering and monitoring of the total power utilization of the facility at a very granular level, providing differentiation between energy consumption for IT equipment and for the facilities if the rest of the building.

Cooling system power

The chilled water plant was common between the Datacenter, labs, and office space. Therefore flow meters and temperature sensors were installed to measure the total cooling load of the building and the Datacenter cooling load as well. All the meters were integrated with the building management system (BMS) for continuous availability of measurements. Figure 5.9 shows the locations of energy meters for measuring cooling power.

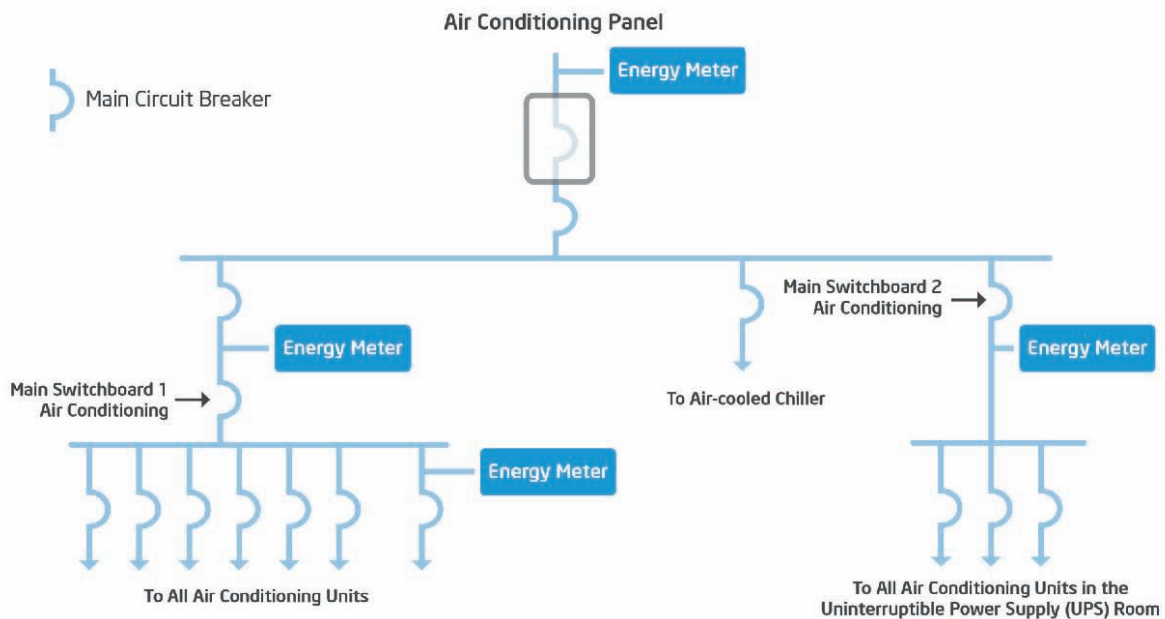

Figure 5.9: Cooling power metering isolated datacenter power from the facilities of the rest of the building

The continuous monitoring and analysis facilitated the implementation of the following energy saving measures:

- › Paralleling the UPS to increase the utilization levels, thereby increasing efficiency and reducing distribution losses
- › Increasing the PAC temperature set point from 19 to 23 degrees Celsius
- › Fine tuning the humidity level controls based on the requirement
- › Managing airflow inside the data center
- › Managing load across the data center floor
- › Using LEDs for emergency lighting inside the Datacenter.
- › Managing standard lighting to reduce energy consumption

Results of the project

The initiatives demonstrated the method to continuously measure and manage the PUE in a datacenter. It resulted in an annual operational power cost saving of Rs 3.85 million with more than 10 percent improvement in overall operational Datacenter efficiency in 2008. The PUE improved from 1.99 to 1.81. Despite an increase in the overall IT load, there has been a reduction in total facilities load.

Table 5.2 and Figure 5.10 summarize the results achieved.

Table 5.2: Power Cost Savings Yielded by Improvements in Power Usage Effectiveness (PUE) Efficiency and Projected Potential Savings

	2007 Annual Load	2007 Load Normalized to 2008 IT Load Level	2008 Annual Load After Efficiency Improvements	Potential Impact of Retrofits PUE= 1.68
IT Average Load per Day (Kilowatt-hours) (A)	10,164	9,672	9,672	9,672
Facilities Average Load per Day (Kilowatt-hours) (B)	10,103	9,575	7,818	6,577
Total Average Data Center Load per Day (A+B)	20,267	19,247	17,490	16,249
Power Usage Effectiveness (PUE = [A+B]/A)	1.99	1.99	1.81	1.68
Data Center Efficiency (DCE = 1/PUE)	50%	50%	55%	60%
Total Power Cost (USD) Annualized	USD 887,693	USD 843,023	USD 766,066	USD 711,706
Actual savings achieved in year 2008 over year 2007: USD 76,597				
Potential savings for year 2009 over year 2007 after planned data center retrofit: USD 131,317				

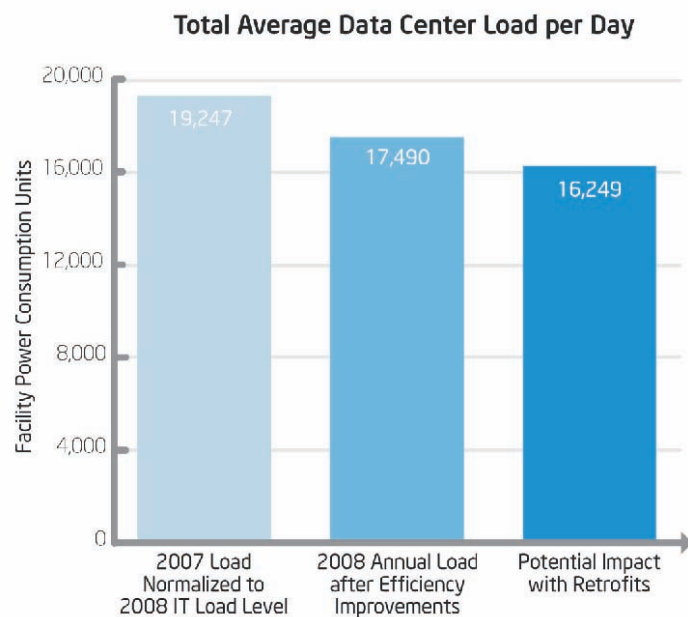

Figure 5.10: Total facilities load reduction

- The project is essential and has to be customized based on the facility infrastructure
- The project involves minor modification/retrofit in the existing system. The project being capital intensive, has to be taken up as part of business decision

Chapter 6

Role of Management in Datacenter Energy Efficiency



6.0 Introduction

The Challenges in Datacenter Energy Management

The Datacenter in an organization is the locus of the storage and processing of vital information in an electronic format; it is a critical area of operation.

Datacenters face two major challenges – maintaining hundred percent availability, and achieving high energy efficiency. Resolving these two challenges requires astute management as the provision of high availability negatively impacts energy efficiency and vice versa. This happens because high availability is usually achieved through integrating multiple redundant systems by design, and this automatically implies a lowering of the energy performance of the overall system. This increases the operating costs of the Datacenter.

In order to maintain a balance between availability and energy efficiency, it is essential to adopt energy-efficient equipment operating within in a highly efficient system. Organizing such a system using the most suitable and energy-efficient equipment is the responsibility of the Datacenter Management.

6.1 The role of management

The Management plays a crucial role not only in the creation of systems and the sourcing of equipment, but also in its operation and maintenance.

The energy management of Datacenters is governed, ultimately, by the operating condition of the system and equipment. The operating conditions in turn, are directly related to the knowledge levels and involvement of the maintenance personnel. Therefore the success of achieving and sustaining energy savings depends on the knowledge level of the technical personnel (maintenance) and their involvement in the goal of achieving maximum energy efficiency.

It is the Management that has to create a platform for technical personnel to continuously improve their knowledge levels by creating opportunities for them to participate in a variety of awareness programs. It is also the Management that has to take the initiative to create and sustain a dedicated energy efficiency Cell, whose members would primarily be concerned with the energy management strategies of the Datacenter. This special cell should be entrusted with conceiving and implementing an energy management plan that subsumes the whole spectrum of energy conservation activities such as measurement, sub-measurement and logging of energy-related parameters, calibration programs, energy audits, energy performance assessments, and budget allocations for introducing and sustaining productive energy-efficiency measures. In order to conceive of and carry through such an energy management plan, the energy efficiency Cell requires the full support of the Datacenter Management.

The following pages elaborate on various energy management strategies that the Management can implement in order to achieve maximum energy efficiency in the Datacenter.

6.2 Energy management strategies

creation of an Energy Management Cell

Successful energy management requires a dedicated Cell – whether it consists of a single energy manager / coordinator or a number of middle managers - working towards planning and implementing it. Only then does the responsibility for energy efficiency and conservation devolve onto a single entity. Such a Cell would occupy a position in the hierarchy somewhere between senior management and the end-users of energy. Leading, coordinating, overseeing and championing energy conservation activities in the Datacenter would be its sole concerns.

Organizing awareness programs

In general, Datacenter maintenance personnel are primarily concerned only with maintaining uptime, and strategizing capacity addition for future growth. Energy efficiency generally finds a place only towards the end in their list of priorities. To change this focus, and reinvent energy conservation and efficiency hiking activities as high-priority activities, the Management has to organize awareness programs to involve and motivate the personnel responsible for the operation of Datacenters. The Management should carry out the following employee motivational activities to generate and sustain interest in energy conservation activities:

- › Send operating/ maintenance personnel for training programs on specific areas such as Server management , storage issues, air management, power distribution management, chiller design and operation, etc
- › Organize regular meeting between executives and technology suppliers to enable personnel to keep abreast of the latest developments in Datacenter infrastructure management technologies
- › Encourage the conduct of seminars and other knowledge-sharing activities in which papers on energy conservation activities can be presented and the latest information in this area can be evaluated

Implementing an Energy Management Plan

Energy management planning involves a cycle of activities: evaluating the energy conservation schemes in an organization, identifying strengths, short-falls, and areas offering scope for positive change, implementing improved systems, procedures and techniques. It acts as a recursive plan for energy efficiency improvement.

The energy management plan should address:

- › The process of identification, implementation and evaluation of energy saving schemes

- › Training of personnel
- › The formulation of strategies to improve efficiency levels, by setting specific time-bound targets, among other measures
- › The involvement of management, middle level managers, operation and maintenance personnel in making energy conservation a sustained activity

6.3 Some components of an energy management plan

Measurement

Measuring energy consumption by logging the energy usage of all the key components in a Datacenter influence decisions involving any modification for performance improvement. The availability of such data eases the process of maintenance by indicating any abnormalities in operation, and thus helps improve the reliability and energy-efficiency of the system.

In order to collect such data, Sub-meters should be installed at key locations to measure energy distribution between IT equipment and support systems. An analysis of the readings of these sub-meters is a powerful tool that accurately measures energy usage and helps in the preparation of an energy balance for the entire system. It enables the monitoring of system performance over the time and provides evidence of positive and negative changes in energy consumption patterns. degradation and improvements.

What is being measured, can be managed

Instrument calibration program

Since measurement plays a vital role in monitoring energy efficiency in a system, it is necessary to ensure the accuracy of the measurements. Running regular programs to verify and calibrate the accuracy of sensors helps to ensure their accuracy, and therefore validates comparisons made over time. Such programs would involve verifying the accuracy of the measuring instrument and re-calibrating it to the measurement standard if required.

Particular attention must be paid to the regular maintenance, verification and calibration of instruments measuring key input parameters. It is also important to maintain a log that records the calibration information of all the pieces of equipment.

What is being measured well, can be managed well

Energy audit

An energy audit is a systematic check-up that offers a real-time profile and model of the Datacenter's energy use conditions, making it possible to identify areas of high energy use and establish a baseline for further improvement activities.

An energy audit involving experts from an external agency would fine-tune the internal process or approach and would help the internal team to identify areas where there is scope for efficiency improvement. Based on the audit, several energy saving activities, like capacity utilization, fine tuning of processes and adopting the latest energy-saving technologies, can be initiated.

Performance assessment

The energy consumed in a Datacenter is utilized for both IT equipment and its support systems. In general, the efficient operation of each of these is assessed and maintained. However, the energy performance of a Datacenter on the whole, is reflected in the effective ratio of the energy utilization for IT equipment, to that for the support systems. The overall performance can be estimated by adopting metrics such as :

- › PUE (Power Utilization Effectiveness)
- › DCIE (Datacenter Infrastructure Efficiency).

Both these measurements indicate how much energy the support systems use in comparison to the IT equipment itself.

The energy utilized for support systems has direct no business-value but has an impact on the cost of operation. The lesser energy the support systems use for a given IT load, the more efficiently the facility operates. Hence, it is necessary to reduce the energy use for support systems to improve the overall performance of a Datacenter. Continuously monitoring this ratio is a good way to keep track of the performance of the whole Datacenter.

Budget allocation

Rational budgeting is a must for implementing energy saving measures in the plant. Budgets for such measures should be made available under the guiding policies of the company. Each investment should be evaluated thoroughly on its technical feasibility and economic viability through ROI calculations like simple pay back period, IRR etc. Budget allocation should be done on an yearly basis and intimated to the Energy Management Cell at the beginning of the year, for the smooth execution of activities. Top management can retain the power for sanctioning larger investments, but decisions on marginal investments should be left to lower or middle management.

Management may choose not to fund a project based on the capital expenditure. The Energy Management team has to clearly present the analysis of the return on investment (ROI) of the proposed action, which will help the Management to compare it to alternative investment options .

6.4 Conclusion

Demonstrating the Management's participation in and commitment to energy management goals, in various ways, is very important. Some of these ways could be framing an energy management plan in accordance with the organization's energy management policy, regular review of energy management projects, the organizing of informational and motivational programs for personnel, and conceptualizing incentive programs that encourage employees to undertake sustained energy conservation activities.

The Management's attitude towards energy efficiency and conservation, as demonstrated by its actions, sets the tone for the whole organization's perception of these issues. Therefore, the onus of initializing and sustaining energy conservation activities in the organization rests with the Management. Positive and proactive energy conservation and energy efficiency increasing measures, undertaken at the Management level, would go a long way in seeing the Indian Datacenter industry emerge as a world leader in energy management.

Annexure

Annexure-1

Grounding

Grounding is a term that has different facets, depending on the application. The reasons for grounding of systems and equipment are,

- › To limit the voltage imposed by lightning
- › To limit line surges or unintentional contact with higher voltages
- › To stabilize the voltage to earth under normal operation
- › To establish an effective path for fault current that is capable of safely carrying the maximum fault current and with sufficiently low impedance to facilitate the operation of over current devices under fault conditions

In addition, the most important application is to increase the protection for people and equipment from shock and/or damage.

In the sense of power quality, grounding plays an important part in the proper operation of "sensitive" equipment. "Of all the power and grounding problems affecting electronic load, almost 90% are caused by electrical power and grounding conditions inside the facility. More importantly, almost 75% of the power quality problems inside the facility relate to grounding, which makes it the single most important factor from a facility standpoint, in having reliable equipment operation.

Improper Earthing-grounding systems not only results in electrical injures and shocks, but may have also result in electrocution.

Note it may be found that the electrical noise levels on protective earthing systems of building installations cause an unacceptable incidence of malfunction on data processing connected to it.

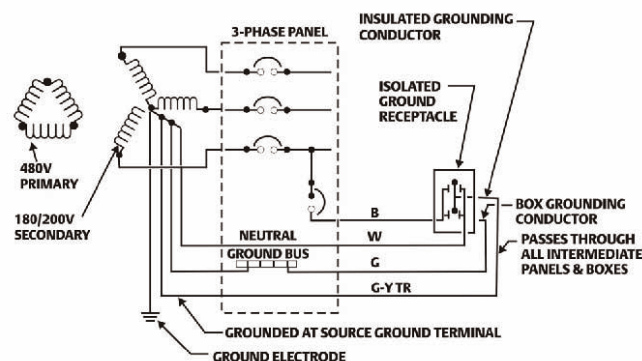

Schematic of Insulated Grounding

Air Management and Air Distribution Metrics

(Source: Texas Instruments)

Rack Cooling Index (RCI):

RCI is a dimensionless measure of how effectively the equipment is cooled within a given intake temperature specification. It provides a measure of the conditions at the high (HI) end and at the low (LO) end of the specified temperature range. $RCI_{HI}=100\%$ means that no intake temperature is above the maximum recommended, and $RCI_{LO}=100\%$ means that no intake temperature is below the minimum recommended. Using ASHRAE Class 1 temperature specification, "poor" conditions are $\leq 90\%$ whereas "good" conditions are $\geq 96\%$. The RCI is assuming the ASHRAE Class 1 recommended intake temperature.

Return Temperature Index (RTI):

The Return Temperature Index (RTI) is a dimensionless measure of the actual utilization of the available temperature differential in the equipment room as well as a measure of the level of by-pass air or recirculation air in the Datacenter. 100% is generally the target; $>100\%$ ® recirculation air; $<100\%$ ® by-pass air.

Supply Heat Index (SHI):

The Supply Heat Index (SHI) is a dimensionless measure of recirculation of hot air into the cold aisles. SHI is a number between 0 and 1 and the lower the better. SHI is typically < 0.40 . An $SHI = 0$ means that all inlet temperatures are equal to the supply temperature.

Annexure-3

Twenty-Seven Things Can be done to Meet “24 by Forever” Expectations

(Source: Uptime Institute)

1. Create a Raised-Floor Master Plan
2. Install computer and infrastructure equipment cabinets in the Cold Aisle/Hot Aisle arrangement
 - a. 14' cold aisle to cold aisle separation with cabinets \leq 42" deep
 - b. 16' cold aisle to cold aisle separation with cabinets $>$ 42" to 48" deep
3. Utilize proper spacing of the cold aisles
 - a. 48" wide with two full rows of tiles which can be removed
 - b. All perforated tiles are only located in the cold aisle
4. Utilize proper spacing of the hot aisles
 - a. Minimum 36" with at least one row of tiles able to be removed
 - b. Do not place perforated tiles in the hot aisle
5. Place cooling units at the end of the equipment rows
 - a. Aligned with hot aisles where possible
6. Face cooling units the same direction
 - a. No "circle the wagons," a.k.a., uniformly distributed cooling
7. Limit maximum cooling unit throw distance to 50'
8. Create appropriate cooling capacity, with redundancy, in each zone of the room (zone maximum is one to two building bays)
 - a. Install minimum of two cooling units even if only one needed.
 - b. Install one-in-six to one-in-eight redundant cooling units in larger areas
9. Use only sensible cooling at 72°F/45% RH when calculating the capacity of cooling units
10. Establish minimum raised- floor height
 - a. 24" if the cabling is overhead, with no chilled water or condenser water pipes under the floor blocking the air flow.
 - b. Recommend 30" to 36" if there are air flow blockages.

11. Place chilled or condenser water pipes in suppressed utility trenches if the computer room is built on grade
12. Establish a minimum clearance of 3' from the top of the cabinets to a ceiling
13. Put Power Distribution Units and Remote Power Panels in line with computer equipment cabinet rows occupying cabinet positions
14. The maximum number of perforated tiles is the total cooling unit air flow divided by 750 cfm = maximum number of perforated tiles to be installed.
 - a. Install only the number of perforated tiles necessary to cool the load being dissipated in the cabinet/rack in the area immediately adjacent to the perforated tile.
 - b. Turn off cooling units that are not required by the heat load (except for redundant units)
15. Do not use perforated tile air flow dampers and remove all existing dampers from the bottoms of perforated tiles (reduces maximum air flow by 1/3, they often close unexplainably and they potentially can produce zinc whiskers).
16. Ensure cabinets are installed with the front face of the frame set on a tile seam in the cold aisle
17. Require cabinet door faces to have a minimum of 50 percent open perforation, 65 percent is better
18. Seal all cable cutouts and other openings in the raised floor with closures. Triton KoldLok® grommets are one solution.
19. Seal all penetrations in the sub floor and perimeter walls under the raised floor and above the dropped ceiling
20. Spread power cables out on the sub floor, preferably under the cold aisle to minimize airflow restrictions
21. Place data cables in trays at the stringer level in the hot aisle
22. If overhead cable racks are used, the racks should run parallel to the rows of racks. Crossover points between rows of racks should be located as far from the cooling units serving the area as practical
23. Prevent internal hot air recirculation by sealing the front of cabinets with blanking plates, including empty areas in the equipment-mounting surface, between the mounting rails, and the edges of the cabinets (if necessary)
24. Ensure all cooling units are functioning properly:
 - a. Set points and sensitivities are consistent

- b. Return air sensors are in calibration—calibrate the calibrator
 - c. Air flow volume is at specified level
 - d. Unit is functioning properly at return air conditions
 - e. Unit produces ≥ 15 F delta T at 100 percent capacity.
25. Be sure the cooling unit's blower motor is turned off if the throttling valve sticks (chilled water type units) or if a compressor fails (air conditioning type unit)
26. Adjust chilled water temperature to eliminate latent cooling
27. Monitor and manage the critical parameters associated with equipment installation, by area of the computer room (no more than two building bays)
- a. Space: Number of cabinets and rack unit space available versus utilized
 - b. Power: PDU output available versus utilized
 - c. Breaker positions: available versus utilized
 - d. Sensible/Redundant cooling capacity available versus utilized
 - e. Floor loading: acceptable weight versus installed cabinet and equipment weight plus dead load of floor and cables, plus live load of people working in area. Compare the actual load with the sub floor structural strength

Datacenter Benchmarking Guide

(Source : Lawrence Berkeley National Laboratory, US)

I. Overall Data Center Performance Metrics

ID	Name	Priority
B1	Data Center Infrastructure Efficiency	1
B2	Power Usage Effectiveness	1
B3	HVAC System Effectiveness	1

B1: Data Center Infrastructure Efficiency (DCiE)

Description:

This metric is the ratio of the IT equipment energy to the total data center energy use. The total data center energy use is the sum of the electrical energy for IT, HVAC system, power distribution, lighting, and any other form of energy use, like steam or chilled water. All the energy data values in the ratio are converted to common units.

Units: Dimensionless

$$B1 = dE2 \div (dE1 + (dE4 + dE5 + dE6))$$

where:

dE1: Total Electrical Energy Use (kWh)

dE2: IT Electrical Energy Use (kWh)

dE4: Total Fuel Energy Use (kWh)

dE5: Total District Steam Energy Use (kWh)

dE6: Total District Chilled Water Energy Use (kWh)

B2: Power Usage Effectiveness (PUE)

Description:

PUE is the inverse of the DCiE metric. This metric is the ratio of the total data center energy use to total IT energy use. The total data center energy use is the sum of the electrical energy for the servers, HVAC system, power distribution, lighting, and any other form of energy use, like steam or chilled water. All the energy data values in the ratio are converted to common units.

Units: Dimensionless

$$B2 = (dE1 + (dE4 + dE5 + dE6)) \div dE2$$

where:

dE1: Total Electrical Energy Use (kWh)

dE2: IT Electrical Energy Use (kWh)

dE4: Total Fuel Energy Use (kWh)

dE5: Total District Steam Energy Use (kWh)

dE6: Total District Chilled Water Energy Use (kWh)

B3: HVAC System Effectiveness

Description:

This metric is the ratio of the IT equipment energy to the HVAC system energy. The HVAC system energy is the sum of the electrical energy for cooling, fan movement, and any other HVAC energy use like steam or chilled water.

Units: Dimensionless

$$B3 = dE2 \div (dE3 + (dE4 + dE5 + dE6))$$

where:

dE2: IT Electrical Energy Use (kWh)

dE3: HVAC Electrical Energy Use (kWh)

dE4: Total Fuel Energy Use (kWh)

dE5: Total District Steam Energy Use (kWh)

dE6: Total District Chilled Water Energy Use (kWh)

II. Air Management Metrics

ID	Name	Priority
A1	Temperature Range	1
A2	Humidity Range	1
A3	Return Temperature Index	1
A4	Airflow Efficiency	1

A1: Temperature: Supply and Return

Description:

This metric is the difference between the supply and return air temperature from the IT equipment in the data center.

Units: °C

$$A1 = dA2 - dA1$$

where:

dA1: Supply air temperature

dA2: Return air temperature

A2: Relative Humidity: Supply and Return

Description:

This metric is the difference of the return and supply air relative humidity from the IT equipment in the data center.

Units: % RH

$$A2 = dA4 - dA3$$

A3: Return Temperature Index

Description:

This metric is a measure of the energy performance of the air management. The primary purpose of improving air management is to isolate hot and cold airstreams. This allows elevating both the supply and return temperatures and maximizes the difference between them while keeping the inlet temperatures within ASHRAE recommendations. It also allows reduction of the system air flow rate. This strategy allows the HVAC equipment to operate more efficiently. The return temperature index (RTI) is ideal at 100% wherein the return air temperature is the same as the temperature leaving the IT equipment.

Units: %

$$A3 = ((dA2 - dA1) / (dA6 - dA5)) \times 100$$

where:

dA1: Supply air temperature

dA2: Return air temperature

dA5: Rack inlet mean temperature

dA6: Rack outlet mean temperature

A4: Airflow Efficiency

Description:

This metric characterizes overall airflow efficiency in terms of the total fan power required per unit of airflow. This metric provides an overall measure of how efficiently air is moved through the data center, from the supply to the return, and takes into account low pressure drop design as well as fan system efficiency.

Units: W/ m³/s

$$A4 = dA7 \div dA8$$

where:

dA7: Total fan power (supply and return) (W)

dA8: Total fan airflow (supply and exhaust) (m³/s)

III. Cooling Metrics

ID	Name	Priority
C1	Data Center Cooling System Efficiency	1
C2	Data Center Cooling System Sizing Factor	1
C3	Air Economizer Utilization Factor	1
C4	Water Economizer Utilization Factor	1

C1: Data Center Cooling System Efficiency

Description:

This metric characterizes the overall efficiency of the cooling system (including chillers, pumps, and cooling towers) in terms of energy input per unit of cooling output. It is an average value depicting average power of the cooling system with respect to the cooling load in the data center.

Units: kW/ton

$$C1: (dC1) \div (dC2)$$

where:

dC1: Average cooling system power usage (kW)

dC2: Average cooling load in the data center (tons)

C2: Cooling System Sizing Factor

Description:

This metric is the ratio of the installed cooling capacity to the peak cooling load.

Units: -

$$C2 = dT8 \div dT9$$

where:

dT8: Installed Chiller Capacity (w/o backup) (tons)

dT9: Peak Chiller Load (tons)

C3: Air Economizer Utilization Factor

Description:

This metric characterizes the extent to which air-side economizer system is being used to provide “free” cooling. It is defined as the percentage of hours in a year that the economizer system can be in full or complete operation (i.e. without any cooling being provided by the chiller plant).

Units: %

$$C3 = (dC5 \div 8760) \times 100$$

where:

dC5: Air economizer hours (full cooling)

C4: Water Economizer Utilization Factor

Description:

This metric is the percentage hours in a year that the water side economizer system meets the entire cooling load of the data center.

Units: %

$$C4 = (dC6 \div 8760) \times 100$$

where:

dC6: Water economizer hours (full cooling)

IV. Electrical Power Chain Metrics

ID	Name	Priority
P1	UPS Load Factor	1
P2	UPS System Efficiency	1
P3	IT or Server Equipment Load Density	1
P4	Lighting Density	3

P1: UPS Load Factor

Description:

This metric is the ratio of the load of the uninterruptible power supply (UPS) to the design value of its capacity. This provides a measure of the UPS system over-sizing and redundancy.

Units: Dimensionless

$$P1 = dP1 \div dP2$$

where:

dP1: UPS peak load (kW)

dP2: UPS load capacity (kW)

P2: Data Center UPS System Efficiency

Description:

This metric is the ratio of the UPS input power to the UPS output power. The UPS efficiency varies depending on its load factor.

Units: %

$$P2 = dP3 \div dP4$$

where:

dP3: UPS input power (kW)

dP4: UPS output power (kW)

P3: IT or Server Equipment Load Density

Description:

This metric is the ratio of the average IT or server power to the electrically active data center area. This metric provides a measure of the power consumed by the servers.

Units: W/m²

$$P3 = (dP5 * 1000) \div dB1$$

where:

dP5: Average IT or server power (W)

dB1: Electrically active area of the data center (m²)

P4: Data Center Lighting Density

Description:

This metric is the ratio of the data center lighting power consumption to the data center area.

Units: W/m²

$$P4 = (dP4 * 1000) \div dB1$$

where

dI4: Data center lighting power (W)

dB1: Data center area (m²)

Data Required for Performance Metrics

ID	Data Item	Measurement/Calculation Guidance
<i>General Data Center Data</i>		
dB1	Data Center Area (electrically active)	
dB2	Data Center Location	
dB3	Data Center Type	
dB4	Year of Construction (or major renovation)	
<i>Data Center Energy Data</i>		
dE1	Total Electrical Energy Use	
dE2	IT Electrical Energy Use	
dE3	HVAC Electrical Energy Use	
dE4	Total Fuel Energy Use	
dE5	Total District Steam Energy Use	
dE6	Total District Chilled Water Energy Use	
<i>Air Management</i>		
dA1	Supply Air Temperature	
dA2	Return Air Temperature	
dA3	Supply Air Relative Humidity	
dA4	Return Air Relative Humidity	
dA5	Rack Inlet Mean Temperature	
dA6	Rack Outlet Mean Temperature	
dA7	Total Fan Power (Supply and Return)	
dA8	Total Fan Airflow rate (Supply and Return)	
<i>Cooling</i>		
dC1	Average Cooling System Power Consumption	
dC2	Average Cooling Load	
dC3	Installed Chiller Capacity (w/o backup)	
dC4	Peak Chiller Load	
dC5	Air Economizer Hours (full cooling)	
dC6	Water Economizer Hours (full cooling)	
<i>Electrical Power Chain</i>		
dP1	UPS Peak Load	
dP2	UPS Load Capacity	
dP3	UPS Input Power	
dP4	UPS Output Power	
dP5	Average IT or Server Power	
dP6	Average Lighting Power	

Annexure-5

List of Energy saving opportunities in Datacenter

Title	Page No.
Case Study 1 - Power Quality Improvement In A Datacenter By Installing Harmonic Filters	43
Case Study 2 - Energy Efficiency Improvement In UPS Systems By Loading Optimization	46
Case Study 3 - Energy Efficiency Improvement in Lighting System By Replacing Fluorescent Lamps With Light Emitting Diode (Lted) Lamps	50
Case Study 4 - Potential benefits of economizer in cooling system	81
Case Study 5 - Introduction of Intelligent Controller for multiple Crac unit system	85
Case Study 6 - Benefits of Electronically Commutted (Ec) Fans For Varying Air Requirement	88
Case Study 7 - Potential benefits of hot Aisle/Cold Aisle Containment	91
Case Study 8 - Introduction of systematic cable Management For Better Air Distribution in Raised Floor System	95
Case Study 9 - Benefits of humidity Control for Energy Efficiency in Datacenter	97
Case Study 10 - Benefits of redefining Inlet Conditions For Energy Efficiency in Datacenter	100
Case Study 11 - Benefits of water cooled cabinets in cooling system	105
Case Study 12 - Operate IT Equipment Cooling System at a Higher Temperature Difference	107
Case Study 13 - CFD Simulation For Enhanced Datacenter Productivity	109
Case Study 14 - Thermal Storage System For Emergency Cooling Requirements	111
Case study 15 - Benefits of a ccelerated server refresh strategy	134
Case study 16 - Enterprise computing performance improvement through consolidation of datacenters	137
Case study 17 - Network virtualization for performance Improvement	139
Case study 18 - Effective storage utilization optimizes datacenter operational cost	141
Case study 19 - Infrastructure efficiency improvement in a virtualized environment	144
Case study 20 - Capturing the benefits through metering and monitoring system for effective energy management	170

References

- › Sun Microsystems white paper on “Energy efficient datacenters - The role of modularity in datacenter design”
- › Pacific Gas & Electric company’s design guidelines source book on “High performance Datacenters”
- › Sun Microsystems white paper on “Energy efficient datacenters - Electrical design”
- › Lawrence Berkeley National Laboratory’s report on “DC Power for Improved Datacenter Efficiency”
- › Schneider electric’s white paper on “DC Power for Improved Datacenter Efficiency”
- › University of Southern California white paper on “Minimizing Datacenter Cooling and Server Power Costs” by Ehsan Pakbaznia and Massoud Pedram
- › Green Grid white paper by “Green grid Datacenter power efficiency metrics: PUE and DCiE”
- › Green Grid white paper on “Seven strategies to improve Datacenter cooling efficiency”
- › Green Grid white paper on “The Green Grid metrics: Datacenter infrastructure efficiency (DCiE) detailed analysis”
- › Green Grid white paper on “Guide lines for Energy-Efficient Datacenters”
- › Intel’s white paper on “Air-Cooled High-Performance Datacenters: Case Studies and Best Methods”
- › <http://www.searchdatacenter.com> – white paper on “Green Datacenter Efficiency Developments” by Brocade
- › IBM’s white paper on “Championing Energy Efficiency in the Datacenter: An IBM Server Consolidation Analysis” April 20, 2007
- › Intel’s white paper on “Intel Eco-Rack Version 1.5”
- › Intel’s white paper on “Turning Challenges into Opportunities in the Datacenter”
- › Sun Microsystems white paper on “Sun Professional Services Sample Case Studies”
- › APC white paper on “Datacenter Projects: Establishing a Floor Plan” By Neil Rasmussen & Wendy Torell
- › CARYAIRE bulletin on “Air distribution products”
- › APC white paper on “ Rack Powering Options for High Density in 230VAC Countries”
- › Intel white paper on “Reducing Datacenter Energy Consumption with Wet Side Economizers” May 2007
- › Intel white paper on “Reducing Datacenter Cost with an Air Economizer” August 2008
- › APC white paper on “A scalable, reconfigurable, and efficient Datacenter power distribution architecture”

- › APC white paper on “Reliability Models for Electric Power Systems”
- › APC white paper on “Comparing UPS System Design Configurations”
- › ACEEE report on “Best Practices for Datacenters: Lessons Learned from Benchmarking 22 Datacenters”
- › Cisco white paper on “Datacenters: Best practices for security and performance”
- › Green Grid white paper on “Fundamentals of Datacenter power and cooling efficiency zones”
- › NetApp white paper on “Case Study: NetApp Air Side Economizer”
- › US Environmental Protection Agency report to Congress on Server and Datacenter Energy Efficiency, August 2007
- › Colorado Springs Utilities white paper on “Energy Efficiency in Computer Datacenters”
- › PTS Datacenter solutions white paper on “Datacenter Cooling Best Practices”
- › Cadence project report on “PC Quest best implementations of the year 2009”
- › Cisco systems white paper on “Airport Uses Network Virtualization to Consolidate and Scale Operations”
- › Cisco systems white paper on “Cisco slashes storage costs with storage recovery program”
- › Cisco best practices manual on “Storage Utilization management”
- › Cisco systems white paper on “Network Virtualization for the campus”
- › CtrlS manual on “Datacenter design philosophy”
- › Emerson Network power write-up on “Best Datacenter design practices”
- › Hewlett Packard white paper on “Storage works virtualization”
- › Hewlett Packard white paper on “Virtualization in business terms”
- › Intel white paper on “Accelerated server refresh reduces datacenter cost”
- › Intel white paper on “Building an enterprise data warehouse and business intelligence solution”
- › Intel white paper on “Expanding Datacenter capacity using water cooled cabinets”
- › Intel white paper on “Implementing Virtualization in global business-computing environment”
- › Intel white paper on “Increasing datacenter efficiency through metering and monitoring power usage”
- › Intel white paper on “Reducing datacenter cost with an air economizer”
- › Intel white paper on “Energy efficient performance for the datacenter”
- › Intel white paper on “Reducing storage growth and cost – A comprehensive approach to storage optimization”
- › Intel white paper on “Thermal storage system provides emergency datacenter cooling”
- › International Resources Group ECO-III Project report on “ Datacenter Benchmarking guide”
- › BMC software education services solution guide on “Managing Datacenter Virtualization”

- › Cisco design guide on “Datacenter infrastructure”
- › DELL & Intel white paper on “Datacenter Operation and Maintenance best practices for critical facilities”
- › Texas Instrument presentation on “Technical audit report”
- › Emerson Network power white paper on “Five Strategies for Cutting Datacenter Energy Costs Through Enhanced Cooling Efficiency”
- › Eaton white paper on “Economic and electrical benefits of harmonic reduction methods in commercial facilities”
- › Emerson Network power report on “Technical Note: Using EC Plug Fans to Improve Energy Efficiency of Chilled Water Cooling Systems in Large Datacenters”
- › APC white paper on “Virtualization: Optimized Power and Cooling to Maximize Benefits”

TERMS AND DEFINITIONS

Source : Green Grid

Blanking panels - Panels typically placed in unallocated portions of enclosed IT equipment racks to prevent internal recirculation of air from the rear to the front of the rack.

Bus, power (or electrical bus) - A physical electrical interface where many devices share the same electric connection, which allows signals to be transferred between devices, allowing information or power to be shared

Chiller - A heat exchanger using air, refrigerant, water and evaporation to transfer heat to produce air conditioning. A chiller is comprised of an evaporator, condenser and compressor system.

Cooling tower - Heat-transfer device, often tower-like, in which atmospheric air cools warm water, generally by direct contact (heat transfer and evaporation).

CRAC (Computer Room Air Conditioner) - A modular packaged environmental control unit designed specifically to maintain the ambient air temperature and/or humidity of spaces that typically contain Datacenter equipment. These products can typically perform all (or a subset) of the following functions: cool, reheat, humidify, dehumidify.

Dehumidifier - A device that removes moisture from air.

Economizer, air – A ducting arrangement and automatic control system that allow a cooling supply fan system to supply outdoor (outside) air to reduce or eliminate the need for mechanical refrigeration during mild or cold weather

Economizer, water - A system by which the supply air of a cooling system is cooled directly or indirectly or both by evaporation of water or by other appropriate fluid (in order to reduce or eliminate the need for mechanical refrigeration)

Efficiency - The ratio of the output to the input of any system. Typically used in relation to energy; smaller amounts of wasted energy denote high efficiencies.

Free standing equipment - Equipment that resides outside of Datacenter racks.

Generator - A machine, often powered by natural gas or diesel fuel, in which mechanical energy is converted to electrical energy

Hot aisle/cold aisle - A common means to optimize cooling in IT equipment rooms by arranging IT equipment in back-to-back rows. Cold supply air from the cold aisle is pulled through the inlets of the IT equipment, and exhausted to a hot aisle to minimize recirculation

Humidifier - A device which adds moisture to the air.

Load - In Datacenters, load represents the total power requirement of all Datacenter equipment (typically servers and storage devices, and physical infrastructure).

PDU (Power Distribution Unit) – A floor or rack mounted enclosure for distributing branch circuit electrical power via cables, either overhead or under a raised floor, to multiple racks or enclosures of IT equipment. The main function of a PDU is to house circuit breakers that are used to create multiple branch circuits from a single feeder circuit. A secondary function of some PDUs is to convert voltage. A Datacenter typically has multiple PDUs.

Pump - Machine for imparting energy to a fluid, causing it to do work.

Rack - Structure for housing electronic equipment.

Raised floor - Raised floors are a building system that utilizes pedestals and floor panels to create a cavity between the building floor slab and the finished floor where equipment and furnishings are located. The cavity can be used as an air distribution plenum to provide conditioned air throughout the raised floor area. When used as an access floor, the cavity can also be used to rout power/data cabling infrastructure and/or water or coolant piping.

rPDU – (Rack-mount Power Distribution Unit) – A device designed to mount in IT equipment racks or cabinets, into which units in the rack are plugged to receive electrical power

Transformer - A device used to transfer an alternating current or voltage from one circuit to another by means of electromagnetic induction.

UPS (Uninterruptible Power Supply) fixed - Typically uses batteries as an emergency power source to provide power to Datacenter facilities until emergency generators come on line. Fixed implies a standalone unit hard wired to the building.

UPS (Uninterruptible Power Supply) modular/scalable - Typically uses batteries as an emergency power source to provide power to Datacenter facilities until emergency generators come on line. Modular/scalable implies units installed in racks with factory-installed whips allowing for physical mobility and flexibility.

Air intake - Device that allows fresh air to enter into the building.

ACH

Air changes per hour, typically referring to outdoor air changes per hour.

Acoustics

Generally, a measure of the noise level in an environment or from a sound source. For a point in an environment, the quantity is sound pressure level in decibels (dB). For a sound source, the quantity is sound power level in either decibels (dB) or bels (B). Either of these quantities may be stated in terms of individual frequency bands or as an overall A-weighted value. Sound output typically is quantified by sound pressure (dBA) or sound power (dB). Densely populated data and communications equipment centers may cause annoyance, affect performance, interfere with communications, or even run the risk of exceeding noise limits (and thus potentially causing hearing damage), and reference should be made to the appropriate regulations and guidelines.

Agile Device

A device that supports automatic switching between multiple Physical Layer technologies. (See IEEE 802.3, Clause 28.).

AHU

Air-handling unit is a device used to condition and circulate air as part of a heating, ventilating, and air-conditioning (HVAC) system.

Air and Liquid Cooling

- Cooling: removal of heat.
- Air cooling: direct removal of heat at its source using air.
- Liquid cooling: direct removal of heat at its source using a liquid (usually water, water / glycol mixture or refrigerant).
- Air-cooled rack or cabinet: system conditioned by removal of heat using air.
- Asterisk denotes definitions from ASHRAE Terminology of Heating, Ventilation, Air Conditioning, & Refrigeration.
- Liquid-cooled rack or cabinet: system conditioned by removal of heat using a liquid.
- Air-cooled equipment: equipment conditioned by removal of heat using air.
- Liquid-cooled equipment: equipment conditioned by removal of heat using a liquid.
- Air-cooled server: server conditioned by removal of heat using air.
- Liquid-cooled server: server conditioned by removal of heat using a liquid.
- Air-cooled blade: blade conditioned by removal of heat using air.
- Liquid-cooled blade: blade conditioned by removal of heat using a liquid.
- Air-cooled board: circuit board conditioned by removal of heat using air.
- Liquid-cooled board: circuit board conditioned by removal of heat using a liquid.
- Air-cooled chip: chip conditioned by removal of heat from the chip using air.
- Liquid-cooled chip: chip conditioned by removal of heat using a liquid. .

Air Inlet Temperature

The temperature measured at the inlet at which air is drawn into a piece of equipment for the purpose of conditioning its components.

Air Outlet Temperature

The temperature measured at the outlet at which air is discharged from a piece of equipment.

Air Short-Cycling

Air conditioners are most efficient when the warmest possible air is returned to them; when cooler-than-expected air is returned to the air conditioner it will perhaps mistakenly read that as the space temperature being satisfied. This air short cycling is because the air is not picking the heat from the space before returning to the air conditioner.

Air Space

The air space below a raised floor or above a suspended ceiling is used to recirculate the air in information technology equipment room/information technology equipment area environment.

Air bypass

Air diverted around a cooling coil in a controlled manner for the purpose of avoiding saturated discharge air. On an equipment room scale, bypass air can also refer to the supply air that “short-cycles” around the load and returns to the air handler without producing effective cooling at the load.

Air cabinet

Air (typically for the purposes of cooling) that passes through a cabinet housing IT Peripheral equipment.

Air conditioned

Air treated to control its temperature, relative humidity, purity, pressure, and movement.

Air equipment

Airflow that passes through the IT or IT Peripheral equipment

Air return (RA)

Air extracted from a space and totally or partially returned to an air conditioner

Air supply

Air entering a space from an air-conditioning system

Air-Cooled Datacenter

Facility cooled by forced air transmitted by raised floor, overhead ducting, or some other method.

Air-Cooled System

Conditioned air is supplied to the inlets of the rack/cabinet for convective cooling of the heat rejected by the components of the electronic equipment within the rack. It is understood that within the rack, the transport of heat from the actual source component (e.g., CPU) within the rack itself can be either liquid or air based, but the heat rejection media from the rack to the terminal cooling device outside of the rack is air.

Annunciator

The portion of a fire alarm control panel, or a remote device attached to the fire alarm control panel that displays the information associated with a notification. Notifications may include alarm or trouble conditions.

Availability

A percentage value representing the degree to which a system or component is operational and accessible when required for use.

Backplane

A printed circuit board with connectors where other cards are plugged. A backplane does not usually have many active components on it in contrast to a system board.

Bandwidth

Data traffic through a device usually measured in bits-per-second.

BAS:

Building automation system.

Baseline

“Baseline” refers to a configuration that is more general and hopefully simpler than one tuned for a specific benchmark. Usually a “baseline” configuration needs to be effective across a variety of workloads, and there may be further restrictions such as requirements about the ease-of-use for any features utilized. Commonly “baseline” is the alternative to a “peak” configuration..

Basis-of-Design

A document that captures the relevant physical aspects of the facility to achieve the performance requirements in support of the mission.

Baud (Bd)

A unit of signaling speed, expressed as the number of times per second the signal can change the electrical state of the transmission line or other medium.

Bay

- A frame containing electronic equipment.
- A space in a rack into which a piece of electronic equipment of a certain size can be physically mounted and connected to power and other input/output devices.

Benchmark

A “benchmark” is a test, or set of tests, designed to compare the performance of one computer system against the performance of others. Note: a benchmark is not necessarily a capacity planning tool. That is, benchmarks may not be useful in attempting to guess the correct size of a system required for a particular use. In order to be effective in capacity planning, it is necessary for the test to be easily configurable to match the targeted use. In order to be effective as a benchmark, it is necessary for the test to be rigidly specified so that all systems tested perform comparable work. These two goals are often at direct odds with one another, with the result that benchmarks are usually useful for comparing systems against each other, but some other test is often required to establish what kind of system is appropriate for an individual’s needs. Every benchmark code of SPEC has a technical advisor who is knowledgeable about the code and the scientific/engineering problem.

BIOS

Basic Input / Output System. The BIOS gives the computer a built-in set of software instructions to run additional system software during computer boot up.

Bipolar Semiconductor Technology

This technology was popular for digital applications until the CMOS semiconductor technology was developed. CMOS drew considerably less power in standby mode and so it replaced many of the bipolar applications around the early 1990s.

Bit Error Ratio (BER)

The ratio of the number of bits received in error to the total number of bits received.

Bit Rate (BR)

The total number of bits per second transferred to or from the Media Access Control (MAC). For example, 100BASE-T has a bit rate of one hundred million bits per second (108 bps).

Blade Server

A modular electronic circuit board, containing one, two, or more microprocessors and memory, that is intended for a single, dedicated application and that can be easily inserted into a space-saving rack with many similar servers. Blade servers, which share a common high-speed bus, are designed to create less heat and thus save energy costs as well as space.

Blanking Panels

Panels typically placed in unallocated portions of enclosed IT equipment racks to prevent internal recirculation of air from the rear to the front of the rack.

Blower

An air-moving device.

BTU

Abbreviation for British thermal units; the amount of heat required to raise one pound of water one degree Fahrenheit, a common measure of the quantity of heat.

Building Automation System (BAS)

Centralized building control typically for the purpose of monitoring and controlling environment, lighting, power, security, fire/life safety, and elevators..

Bus Power (or Electrical Bus)

A physical electrical interface where many devices share the same electric connection, which allows signals to be transferred between devices, allowing information or power to be shared.

Cabinet

Frame for housing electronic equipment that is enclosed by doors and is stand-alone; this is generally found with high-end servers.

CAV

Constant air volume

CFD

Computational fluid dynamics. A computational technology that enables you to study the dynamics of fluid flow and heat transfer numerically.

CFM

The abbreviation for cubic feet per minute commonly used to measure the rate of air flow in systems that move air.

Chassis

The physical framework of the computer system that houses all electronic components, their interconnections, internal cooling hardware, and power supplies..

Chilled Water System

A type of air-conditioning system that has no refrigerant in the unit itself. The refrigerant is contained in a chiller, which is located remotely. The chiller cools water, which is piped to the air conditioner to cool the space. An air or process conditioning system containing chiller(s), water pump(s), a water piping distribution system, chilled-water cooling coil(s), and associated controls. The refrigerant cycle is contained in a remotely located water chiller. The chiller cools the water, which is pumped through the piping system to the cooling coils.

Chip

The term “chip” identifies the actual microprocessor, the physical package containing one or more “cores”.

Classes of Fires

Class A: fires involving ordinary combustibles such as paper, wood, or cloth

Class B: fires involving burning liquids

Class C: fires involving any fuel and occurring in or on energized electrical equipment

Class D: fires involving combustible metals (such as magnesium)

Client

A server system that can operate independently but has some interdependence with another server system.

Cluster

Two or more interconnected servers that can access a common storage pool. Clustering prevents the failure of a single file server from denying access to data and adds computing power to the network for large numbers of users.

CMOS Electronic Technology

This technology draws considerably less power than bipolar semiconductor technology in standby mode and so it replaced many of the digital bipolar applications around the early 1990s.

Coefficient of Performance (COP) - Cooling

The ratio of the rate of heat removal to the rate of energy input, in consistent units, for a complete cooling system or factory-assembled equipment, as tested under a nationally recognized standard or designated operating conditions.

Cold Plate

Cold plates are typically aluminum or copper plates of metal that are mounted to electronic components. Cold plates can have various liquids circulating within their channels. Typically, a plate with cooling passages through which liquid flows to remove the heat from the electronic component to which it is attached.

Commissioning Levels

- › Factory acceptance tests (Level 1 commissioning): the testing of products prior to leaving their place of manufacture
- › Field component verification (Level 2 commissioning): the inspection and verification of products upon receipt
- › System construction verification (Level 3 commissioning): field inspections and certifications that components are assembled and properly integrated into systems as required by plans and specifications
- › site acceptance testing (Level 4 commissioning): activities that demonstrate that related components, equipment, and ancillaries that make up a defined system operate and function to rated, specified, and/or advertised performance criteria
- › integrated systems tests (Level 5 commissioning): the testing of redundant and backup components, systems, and groups of interrelated systems to demonstrate that they respond as predicted to expected and unexpected anomalies .

Commissioning Plan

A document that defines the verification and testing process to ensure the project delivers what is expected, including training, documentation, and project close-out.

Commissioning

The process of ensuring that systems are designed, installed, functionally tested, and capable of being operated and maintained to perform in conformity with the design intent; it begins with planning and includes design, construction, start-up, acceptance, and training and can be applied throughout the life of the building..

Communication Equipment

Equipment used for information transfer. The information can be in the form of digital data, for data communications, or analog signals, for traditional wireline voice communication.

- › Core Network or Equipment: A core network is a central network into which other networks feed. Traditionally, the core network has been the circuit-oriented telephone system. More recently, alternative optical networks bypass the traditional core and implement packet-oriented technologies. Significant to core networks is “the edge,” where networks and users exist. The edge may perform intelligent functions that are not performed inside the core network.
- › Edge Equipment or Devices: In general, edge devices provide access to faster, more efficient backbone and core networks. The trend is to make the edge smart and the core “dumb and fast.” Edge devices may translate between one type of network protocol and another. .

Compute Server

Servers dedicated for computation or processing that are typically required to have greater processing power (and, hence, dissipate more heat) than servers dedicated solely for storage.

Compute-Intensive

The term that applies to any computer application demanding very high computational power, such as meteorology programs and other scientific applications. A similar but distinct term, computer-intensive, refers to applications that require a lot of computers, such as grid computing. The two types of applications are not necessarily mutually exclusive; some applications are both compute- and computer-intensive.

Computer System Availability

Probability that a computer system will be operable at a future time (takes into account the effects of failure and repair/maintenance of the system).

Computer System Reliability

Probability that a computer system will be operable throughout its mission duration (only takes into account the effects of failure of the system).

Condenser

Heat exchanger in which vapor is liquefied (state change) by the rejection of heat as a part of the refrigeration cycle

Conditioned Air

Air treated to control its temperature, relative humidity, purity, pressure, and movement..

Cooling Tower

Heat-transfer device, often tower-like, in which atmospheric air cools warm water, generally by direct contact (heat transfer and evaporation)

Cooling Air

Conditioned air is supplied to the inlets of the rack/cabinet/server for convective cooling of the heat rejected by the components of the electronic equipment within the rack. It is understood that within the rack, the transport of heat from the actual source component (e.g., CPU) within the rack itself can

be either liquid or air based, but the heat rejection media from the rack to the building cooling device outside the rack is air. The use of heat pipes or pumped loops inside a server or rack where the liquid remains is still considered air cooling

Cooling Liquid

Conditioned liquid is supplied to the inlets of the rack/cabinet/server for thermal cooling of the heat rejected by the components of the electronic equipment within the rack. It is understood that within the rack, the transport of heat from the actual source component (e.g., CPU) within the rack itself can be either liquid or air based (or any other heat transfer mechanism), but the heat rejection media to the building cooling device outside of the rack is liquid

Core

The term “core” is used to identify the core set of architectural, computational processing elements that provide the functionality of a CPU

CPU

Central Processing Unit, also called a processor. In a computer the CPU is the processor on an IC chip that serves as the heart of the computer, containing a control unit, the arithmetic and logic unit (ALU), and some form of memory. It interprets and carries out instructions, performs numeric computations, and controls the external memory and peripherals connected to it..

CRAC (Computer Room Air Conditioning)

A modular packaged environmental control unit designed specifically to maintain the ambient air temperature and/or humidity of spaces that typically contain IT Peripheral equipment. These products can typically perform all or some of the following functions: cool, reheat, humidify, dehumidify. They may have multiple steps for some of these functions. CRAC units should be specifically designed for data and communications equipment room applications and meet the requirements of ANSI/ASHRAE Standard.

Datacenter

A building or portion of a building whose primary function is to house a computer room and its support areas; Datacenters typically contain high-end servers and storage products with mission-critical functions.

Data Terminal Equipment (DTE)

Any source or destination of data connected to the local area network..

IT Peripheral

A term that is used as an abbreviation for the data and communications industry

Dataset

The set of inputs for a particular benchmark. There may be more than one dataset available for each benchmark each serving a different purpose (e.g. measurement versus testing) or configured for different problem sizes (small, medium, large, ...).

dBm

Decibels referenced to 1.0 mW.

Dehumidification

The process of removing moisture from air

Direct Expansion (DX) System

A system in which the cooling effect is obtained directly from the refrigerant; it typically incorporates a compressor, and in most cases the refrigerant undergoes a change of state in the system.

Disk Unit

Hard disk drive installed in a piece of IT Peripheral equipment, such as a personal computer, laptop, server, or storage product.

Diversity

A factor used to determine the load on a power or cooling system based on the actual operating output of the individual equipment rather than the full-load capacity of the equipment.

Diversity

Two definitions for diversity exist, diverse routing and diversity from maximum.

- ▶ Systems that employ an alternate path for distribution are said to have diverse routing. In terms of an HVAC system, it might be used in reference to an alternate chilled water piping system. To be truly diverse (and of maximum benefit) both the normal and alternate paths must each be able to support the entire normal load
- ▶ Diversity can also be defined as a ratio of maximum to actual for metrics such as power loads. For

example, the nominal power loading for a rack may be based on the maximum configuration of components, all operating at their maximum intensities. Diversity would take into account variations from the maximum in terms of rack occupancy, equipment configuration, operational intensity, etc., to provide a number that could be deemed to be more realistic

Domain

A group of computers and devices on a network that are administered as a unit with common rules and procedures. Within the Internet, domains are defined by the IP address. All devices sharing a common part of the IP address are said to be in the same domain

Down Time

A period of time during which a system is not operational, due to a malfunction or maintenance

Downflow air system

Refers to a type of air-conditioning system that discharges air downward, directly beneath a raised floor, commonly found in computer rooms and modern office spaces

Dry-Bulb Temperature (DB)

Temperature of air indicated by an ordinary thermometer

Drywell

A well in a piping system that allows a thermometer or other device to be inserted without direct contact with the liquid medium being measured.

Economizer, Air

A ducting arrangement and automatic control system that allow a cooling supply fan system to supply outdoor (outside) air to reduce or eliminate the need for mechanical refrigeration during mild or cold weather.

Economizer, Water

A system by which the supply air of a cooling system is cooled directly or indirectly or both by evaporation of water or by other appropriate fluid (in order to reduce or eliminate the need for mechanical refrigeration).

Efficiency, HVAC System

The ratio of the useful energy output (at the point of use) to the energy input, in consistent units, for a designated time period, expressed in percent.

Efficiency

The ratio of the output to the input of any system. Typically used in relation to energy; smaller amounts of wasted energy denote high efficiencies

Electromagnetic Compatibility (EMC)

The ability of electronic equipment or systems to operate in their intended operational environments without causing or suffering unacceptable degradation because of electromagnetic radiation or response

Electronically Commutated Motor (ECM)

An EC motor is a DC motor with a shunt characteristic. The rotary motion of the motor is achieved by supplying the power via a switching device-the so-called commutator. On the EC motors, this commutation is performed using brushless electronic semiconductor modules

Energy Efficiency Ratio (EER)

The ratio of net equipment cooling capacity in Btu/h to total rate of electric input in watts under designated operating conditions. When consistent units are used, this ratio becomes equal to COP

Equipment Room

Datacenter or central office room that houses computer and/or telecom equipment. For rooms housing mostly telecom equipment

Equipment Room

Refers to, but not limited to, servers, storage products, workstations, personal computers, and transportable computers. May also be referred to as electronic equipment or IT equipment..

ESD

Electrostatic Discharge (ESD), the sudden flow of electricity between two objects at different electrical potentials. The transfer of voltage between two objects at different voltage potentials. ESD is a primary cause of integrated circuit damage or failure.

Evaporative Condenser

Condenser in which the removal of heat from the refrigerant is achieved by the evaporation of water from the exterior of the condensing surface, induced by the forced circulation of air and sensible cooling by the air..

Fan Sink

A heat sink with a fan directly and permanently attached

Fan

Device for moving air by two or more blades or vanes attached to a rotating shaft.

- › Airfoil fan: shaped blade in a fan assembly to optimize flow with less turbulence.
- › Axial fan: fan that moves air in the general direction of the axis about which it rotates.
- › Centrifugal fan: fan in which the air enters the impeller axially and leaves it substantially in a radial direction.
- › Propeller fan: fan in which the air enters and leaves the impeller in a direction substantially parallel to its axis. .

Fault Tolerance

The ability of a system to respond gracefully and meet the system performance specifications to an unexpected hardware or software failure. There are many levels of fault tolerance, the lowest being the ability to continue operation in the event of a power failure. Many fault-tolerant computer systems mirror all operations-that is, every operation is performed on two or more duplicate systems, so if one fails, the other can take over

Fenestration

An architectural term that refers to the arrangement, proportion, and design of window, skylight, and door systems within a building

Fiber Optic Cable

A cable containing one or more optical fibers

Filter Dryer

Encased desiccant, generally inserted in the liquid line of a refrigeration system and sometimes in the suction line, to remove entrained moisture, acids, and other c-ontaminants.

Float Voltage

Optimum voltage level at which a battery string gives maximum life and full capacity

Flux

Amount of some quantity flowing across a given area (often a unit area perpendicular to the flow) per unit time. Note: The quantity may be, for example, mass or volume of a fluid, electromagnetic energy, or number of particles. .

Heat Exchanger

Device to transfer heat between two physically separated fluids.

- ▶ Counterflow heat exchanger: heat exchanger in which fluids flow in opposite directions approximately parallel to each other.
- ▶ Cross-flow heat exchanger: heat exchanger in which fluids flow perpendicular to each other.
- ▶ Heat pipe heat exchanger: Tubular closed chamber containing a fluid in which heating one end of the pipe causes the liquid to vaporize and transfer to the other end where it condenses and dissipates its heat. The liquid that forms flows back toward the hot end by gravity or by means of a capillary wick
- ▶ Parallel-flow heat exchanger: heat exchanger in which fluids flow approximately parallel to each other and in the same direction
- ▶ Plate heat exchanger or plate liquid cooler: thin plates formed so that liquid to be cooled flows through passages between the plates and the cooling fluid flows through alternate passages. .

Heat Load per Product Footprint

Calculated by using product measured power divided by the actual area covered by the base of the cabinet or equipment.

Heat Load, Latent

Cooling load to remove latent heat, where latent heat is a change of enthalpy during a change of state.

Heat Load, Sensible

The heat load that causes a change in temperature

Heat Sink

Component designed to transfer heat from an electronic device to a fluid. Processors, chipsets, and other high heat flux devices typically require heat sinks..

Heat, Total (Enthalpy)

A thermodynamic quantity equal to the sum of the internal energy of a system plus the product of the pressure-volume work done on the system: $h = E + pv$ where h = enthalpy or total heat content, E = internal energy of the system, p = pressure, and v = volume. For the purposes of this document, h = sensible heat + latent heat. sensible heat: heat that causes a change in temperature latent heat: change of enthalpy during a change of state .

Heat

- › Total Heat (Enthalpy): A thermodynamic quantity equal to the sum of the internal energy of a system plus the product of the pressure-volume work done on the system. $h = E + pv$ where h = enthalpy or total heat content, E = internal energy of the system, p = pressure, and v = volume. For the purposes of this paper, h = sensible heat + latent heat.
 - Sensible Heat: Heat that causes a change in temperature.
 - Latent Heat: Change of enthalpy during a change of state. .

High Performance Computing and Communications (HPCC)

High performance computing includes scientific workstations, supercomputer systems, high speed networks, special purpose and experimental systems, the new generation of large-scale parallel systems, and application and systems software with all components well integrated and linked over a high speed network..

High-Efficiency Particulate Air (HEPA) Filters

These filters are designed to remove 99.97% or more of all airborne pollutants 0.3 microns or larger from the air that passes through the filter. There are different levels of cleanliness, and some HEPA filters are designed for even higher removal efficiencies and/or removal of smaller particles

Horizontal Displacement (HDP)

An air-distribution system used to introduce air horizontally from one end of a cold aisle

Horizontal Overhead (HOH)

An air-distribution system that is used to introduce the supply air horizontally above the cold aisles and is generally utilized in raised-floor environments where the raised floor is used for cabling..

Hot Aisle/Cold Aisle

A common means of providing cooling to IT Peripheral rooms in which IT equipment is arranged in rows and cold supply air is supplied to the cold aisle, pulled through the inlets of the IT equipment, and exhausted to a hot aisle to minimize recirculation of the hot exhaust air with the cold supply air.

- ▶ A common arrangement for the perforated tiles and the IT Peripheral equipment. Supply air is introduced into a region called the cold aisle.
- ▶ On each side of the cold aisle, equipment racks are placed with their intake sides facing the cold aisle. A hot aisle is the region between the backs of two rows of racks.
- ▶ The cooling air delivered is drawn into the intake side of the racks. This air heats up inside the racks and is exhausted from the back of the racks into the hot aisle. .

Humidification

The process of adding moisture to air or gases

Humidity Ratio

The ratio of the mass of water to the total mass of a moist air sample. It is usually expressed as grams of water per kilogram of dry air (gw/kgda) or as pounds of water per pound of dry air (lbw/lbda)..

Humidity

Water vapor within a given space.

Absolute Humidity: The mass of water vapor in a specific volume of a mixture of water vapor and dry air.

Relative Humidity: Ratio of the partial pressure or density of water vapor to the saturation pressure or density, respectively, at the same dry-bulb temperature and barometric pressure of the ambient air. Ratio of the mole fraction of water vapor to the mole fraction of water vapor saturated at the same temperature and barometric pressure. At 100% relative humidity, the dry-bulb, wet-bulb, and dew-point temperatures are equal.

Hydrofluorocarbon (HFC)

A halocarbon that contains only fluorine, carbon, and hydrogen

IEC

International Electrotechnical Commission; a global organization that prepares and publishes international standards for all electrical, electronic, and related technologies..

IEEE

Formerly, the Institute of Electrical and Electronics Engineers, Inc..

Infiltration

Flow of outdoor air into a building through cracks and other unintentional openings and through the normal use of exterior doors for entrance and egress; also known as air leakage into a building

Leakage Airflow

Any airflow that does not flow along an intended path is considered to be a leakage in the system. Leakage airflow results in excess fan energy and may also result in higher energy consumption of refrigeration equipment

Mean Time To Repair (or Recover) (MTTR)

The expected time to recover a system from a failure, usually measured in hours.

Memory

Memory is a Internal storage area in a computer. The term memory identifies data storage that comes in the form of silicon, and the word storage is used for memory that exists on tapes or disks. The term memory is usually used as shorthand for physical memory, which refers to the actual chips capable of holding data. Some computers also use virtual memory, which expands physical memory onto a hard disk.

Metric

The final results of a benchmark. The significant statistics reported from a benchmark run. Each benchmark defines what are valid metrics for that particular benchmark..

Minimum Efficiency Reporting Value (MERV)

Previously there were several specifications used to determine filter efficiency and characteristics. ASHRAE has developed the MERV categories so that a single number can be used to select and specify filters

MTBF

Mean time between failures

Nameplate Rating

Term used for rating according to nameplate: "Equipment shall be provided with a power rating marking, the purpose of which is to specify a supply of correct voltage and frequency, and of adequate current-carrying capacity"

Non-Raised Floor

Facilities without a raised floor utilize overhead ducted supply air to cool equipment. Ducted overhead supply systems are typically limited to a cooling capacity of 100 W/ft²

OEM

Original Equipment Manufacturer. Describes a company that manufactures equipment that is then marketed and sold to other companies under their own names..

Optical Fiber

A filament-shaped optical waveguide made of dielectric materials..

Pascal (PA)

A unit of pressure equal to one newton per square meter. As a unit of sound pressure, one pascal corresponds to a sound pressure level of 94

Perforated Floor Tile

A tile as part of a raised-floor system that is engineered to provide airflow from the cavity underneath the floor to the space, tiles may be with or without volume dampers.

Performance Neutral

Performance neutral means that there is no significant difference in performance. For example, a performance neutral source code change would be one which would not have any significant impact on the performance as measured by the benchmark

Plenum

A compartment or chamber to which one or more air ducts are connected and that forms part of the air distribution system

Point of Presence (PoP)

A PoP is a place where communication services are available to subscribers. Internet service providers have one or more PoPs within their service area that local users dial into. This may be co-located at a carrier's central office

Power

Time rate of doing work, usually expressed in horsepower or watts..

Psychrometric Chart

A graph of the properties (temperature, relative humidity, etc.) of air; it is used to determine how these properties vary as the amount of moisture (water vapor) in the air changes.

Pump

Machine for imparting energy to a fluid, causing it to do work.

- › Centrifugal pump: Pump having a stationary element (casing) and a rotary element (impeller) fitted with vanes or blades arranged in a circular pattern around an inlet opening at the center. The casing surrounds the impeller and usually has the form of a scroll or volute.
- › Diaphragm pump: Type of pump in which water is drawn in and forced out of one or more chambers by a flexible diaphragm. Check valves let water into and out of each chamber.
- › Positive displacement pump: Has an expanding cavity on the suction side and a decreasing cavity on the discharge side. Liquid flows into the pump as the cavity on the suction side expands and the liquid flows out of the discharge as the cavity collapses. Examples of positive displacement pumps include reciprocating pumps and rotary pumps.
- › Reciprocating pump: A back-and-forth motion of pistons inside of cylinders provides the flow of fluid. Reciprocating pumps, like rotary pumps, operate on the positive principle; that is, each stroke delivers a definite volume of liquid to the system.
- › Rotary pump: Pumps that deliver a constant volume of liquid regardless of the pressure they encounter. A constant volume is pumped with each rotation of the shaft and this type of pump is frequently used as a priming pump

Rack Power

Used to denote the total amount of electrical power being delivered to electronic equipment within a given rack. Often expressed in kilowatts (kW), this is often incorrectly equated to be the heat dissipation from the electrical components of the rack

Rack

- › Structure for housing electronic equipment. Differing definitions exist between the computing industry and the telecom industry
- › Computing Industry: A rack is enclosed cabinet housing computer equipment. The front and back panels may be solid, perforated, or open depending on the cooling requirements of the equipment within.
- › Telecom Industry: A rack is a framework consisting of two vertical posts mounted to the floor and a series of open shelves upon which electronic equipment is placed. Typically, there are no enclosed panels on any side of the rack. .

Rack-Mounted Equipment

The Equipment that is mounted in a cabinet. These systems are generally specified in units such as 1U, 2U, 3U, etc., where 1U = 1.75 inches (44 mm)

Raised Floor

A platform with removable panels where equipment is installed, with the intervening space between it and the main building floor used to house the inter-connecting cables, which at times is used as a means for supplying conditioned air to the information technology equipment and the room. Also known as access floor. Raised floors are a building system that utilizes pedestals and floor panels to create a cavity between the building floor slab and the finished floor where equipment and furnishings are located. The cavity can be used as an air distribution plenum to provide conditioned air throughout the raised floor area. The cavity can also be used for routing of power/data cabling infrastructure..

Rated Current

The rated current is the absolute maximum current that is required by the unit from an electrical branch circuit..

Rated Frequency Range

The supply frequency range as declared by the manufacturer, expressed by its lower and upper rated frequencies..

Rated Frequency

The supply frequency as declared by the manufacturer..

Rated Voltage Range

The supply voltage range as declared by the manufacturer. .

Rated Voltage

The supply voltage as declared by the manufacturer..

Redundancy

“N” represents the number of pieces to satisfy the normal conditions. Redundancy is often expressed compared to the baseline of “N”; some examples are “N+1,” “N+2,” “2N,” and 2(N+1). A critical decision is whether “N” should represent just normal conditions or whether “N” includes full capacity during off-line routine maintenance. Facility redundancy can apply to an entire site (backup site), systems, or components. IT redundancy can apply to hardware and software

Refrigerants

In a refrigerating system, the medium of heat transfer that picks up heat by evaporating at a low temperature and pressure and gives up heat on condensing at a higher temperature and pressure.

Relative Humidity (RH)

(a) ratio of the partial pressure or density of water vapor to the saturation pressure or density, respectively, at the same dry-bulb temperature and barometric pressure of the ambient air;

(b) ratio of the mole fraction of water vapor to the mole fraction of water vapor saturated at the same temperature and barometric pressure-at 100% relative humidity, the dry-bulb, wet-bulb, and dew-point temperatures are equal.

Releasing Panel

A particular fire alarm control panel whose specific purpose is to monitor fire detection devices in a given area protected by a suppression system and, upon receiving alarm signals from those devices, actuate the suppression system

Reliability

A percentage value representing the probability that a piece of equipment or system will be operable throughout its mission duration. Values of 99.9% (three 9s) and higher are common in data and communications equipment areas. For individual components, the reliability is often determined through testing. For assemblies and systems, reliability is often the result of a mathematical evaluation based on the reliability of individual components and any redundancy or diversity that may be employed.

Reliability is a percentage value representing the probability that a piece of equipment or system will be operable throughout its mission duration. Values of 99.9 percent (three 9s) and higher are common in data and communications equipment areas. For individual components, the reliability is often determined through testing. For assemblies and systems, reliability is often the result of a mathematical evaluation based on the reliability of individual components and any redundancy or diversity that may be employed

Semiconductor

A material that is neither a good conductor of electricity nor a good insulator. The most common semiconductor materials are silicon, gallium arsenide, and germanium. These materials are then doped to create an excess or lack of electrons and used to build computer chips..

Sensible Heat Ratio (SHR)

ratio of the sensible heat load to the total heat load (sensible plus latent).

Server

A computer that provides some service for other computers connected to it via a network; the most common example is a file server, which has a local disk and services requests from remote clients to read and write files on that disk.

Service Level Agreement (SLA)

A contract between a network service provider and a customer that specifies, usually in measurable terms, what services the network service provider will furnish.

Single-Point Failure

Any component that has the capability of causing failure of a system or a portion of a system if it becomes inoperable..

SPEC

Standard Performance Evaluation Corporation. SPEC is an organization of computer industry vendors dedicated to developing standardized benchmarks and publishing reviewed results

SPECrate

A “SPECrate” is a throughput metric based on the SPEC CPU benchmarks (such as SPEC CPU95). This metric measures a system’s capacity for processing jobs of a specified type in a given amount of time.

Note: This metric is used the same for multi-processor systems and for uniprocessors. It is not necessarily a measure of how fast a processor might be, but rather a measure of how much work the one or more processors can accomplish. The other kind of metrics from the SPEC CPU suites are SPECratios, which measure the speed at which a system completes a specified job. .

SPECratio

A measure of how fast a given system might be. The "SPECratio" is calculated by taking the elapsed time that was measured for a system to complete a specified job, and dividing that into the reference time (the elapsed time that job took on a standardized reference machine). This measures how quickly, or more specifically: how many times faster than a particular reference machine, one system can perform a specified task. "SPECratios" are one style of metric from the SPEC CPU benchmarks, the other are SPECrates. .

Switchgear

Combination of electrical disconnects and/or circuit breakers meant to isolate equipment in or near an electrical substation.

Temperature

- › Dew Point: The temperature at which water vapor has reached the saturation point (100% relative humidity).
- › Dry Bulb: The temperature of air indicated by a thermometer.
- › Wet Bulb: The temperature indicated by a psychrometer when the bulb of one thermometer is covered with a water-saturated wick over which air is caused to flow at approximately 4.5 m/s (900 ft/min) to reach an equilibrium temperature of water evaporating into air, where the heat of vaporization is supplied by the sensible heat of the air. .

Thermal Storage Tank

Container used for the storage of thermal energy; thermal storage systems are often used as a component of chilled-water systems.

Tonnage

The unit of measure used in air conditioning to describe the heating or cooling capacity of a system. One ton of heat represents the amount of heat needed to melt one ton (2000 lb) of ice in one hour; 12,000 Btu/hr or 3024 kcals/hr equals one ton of refrigeration

Turn-Down Ratio

Ratio representing highest and lowest effective system capacity. Calculated by dividing the maximum system output by the minimum output at which steady output can be maintained. For example, a 3:1 turn-down ratio indicates that minimum operating capacity is one-third of the maximum

UPS, Static

Typically uses batteries as an emergency power source to provide power to IT Peripheral facilities until emergency generators come on line

Uptime

- ▶ Uptime is a computer industry term for the time during which a computer is operational. Downtime is the time when it isn't operational.
- ▶ Uptime is sometimes measured in terms of a percentile. For example, one standard for uptime that is sometimes discussed is a goal called five 9s-that is, a computer that is operational 99.999 percent of the time. .

Valve

A device to stop or regulate the flow of fluid in a pipe or a duct by throttling..

VAV

variable air volume.

Ventilation

The process of supplying or removing air by natural or mechanical means to or from any space; such air may or may not have been conditioned .

VFD

variable frequency drive is a system for controlling the rotational speed of an alternating current (AC) electric motor by controlling the frequency of the electrical power supplied to the motor.

Virtual Private Network (VPN)

The use of encryption in the lower protocol layers to provide a secure connection through an otherwise insecure network, typically the Internet. VPNs are generally cheaper than real private networks using private lines but rely on having the same encryption system at both ends. The encryption may be performed by firewall software or possibly by routers..

Virtual Server

- › A configuration of a networked server that appears to clients as an independent server but is actually running on a computer that is shared by any number of other virtual servers. Each virtual server can be configured as an independent Web site, with its own hostname, content, and security settings.
- › Virtual servers allow Internet service providers to share one computer between multiple Web sites while allowing the owner of each Web site to use and administer the server as though they had complete control. .

Virtual

Common alternative to logical, often used to refer to the artificial objects (such as addressable virtual memory larger than physical memory) created by a computer system to help the system control access to shared resources

Volatile Organic Compounds (VOCs)

Organic (carbon-containing) compounds that evaporate readily at room temperature; these compounds are used as solvents, degreasers, paints, thinners and fuels.

VSD

Variable speed drive is a system for controlling the rotational speed of either an alternating current (AC) or direct current (DC) motor by varying the voltage to the electrical power supplied to the motor.

Workload

The workload is the definition of the units of work that are to be performed during a benchmark run

